



US00D379675S

# United States Patent [19] Ichiyanagi

[11] Patent Number: **Des. 379,675**

[45] Date of Patent: **\*\*Jun. 3, 1997**

[54] SAFETY RAZOR CARTRIDGE

[75] Inventor: **Masao Ichiyanagi**, Seki, Japan

[73] Assignee: **Feather Safety Razor Co., Ltd.**,  
Osaka-Fu, Japan

[\*\*] Term: **14 Years**

[21] Appl. No.: **25,640**

[22] Filed: **Jul. 7, 1994**

[51] LOC (6) Cl. .... **28-03**

[52] U.S. Cl. .... **D28/47**

[58] Field of Search ..... D28/46, 47; 30/32,  
30/34.2, 48-51, 59

[56] **References Cited**

**U.S. PATENT DOCUMENTS**

D. 250,775	1/1979	Chen	.....	D28/47
D. 253,375	11/1979	Chen	.....	D28/47
D. 314,249	1/1991	Bowman	.....	D28/47
D. 329,105	9/1992	Chen	.....	D28/47
3,890,704	6/1975	Ferraro	.....	30/50 X
4,354,312	10/1982	Trotta	.....	30/50 X
4,985,995	1/1991	Coffin	.....	30/60.5 X
5,063,669	11/1991	Althaus	.....	30/50 X
5,084,969	2/1992	Althaus	.....	30/77 X
5,359,774	11/1994	Althaus	.....	30/32 X

**FOREIGN PATENT DOCUMENTS**

289228	1/1988	European Pat. Off.	.....	30/32
348866	1/1990	European Pat. Off.	.....	30/32

*Primary Examiner*—Ted Shooman  
*Assistant Examiner*—C. Tuttle  
*Attorney, Agent, or Firm*—Nawrocki, Rooney & Sivertson,  
P.A.

[57] **CLAIM**

The ornamental design for a safety razor cartridge, as shown and described.

**DESCRIPTION**

FIG. 1 is a top plan view of a safety razor cartridge showing my new design;  
FIG. 2 is a left side elevational view thereof;  
FIG. 3 is a right side elevational view thereof;  
FIG. 4 is a front elevational view thereof;  
FIG. 5 is a rear elevational view thereof;  
FIG. 6 is a perspective view thereof; and,  
FIG. 7 is a front perspective view thereof with a holder attached thereto.  
The broken line showing of the razor handle is for illustrative purposes only and forms no part of the claimed design.

**1 Claim, 3 Drawing Sheets**

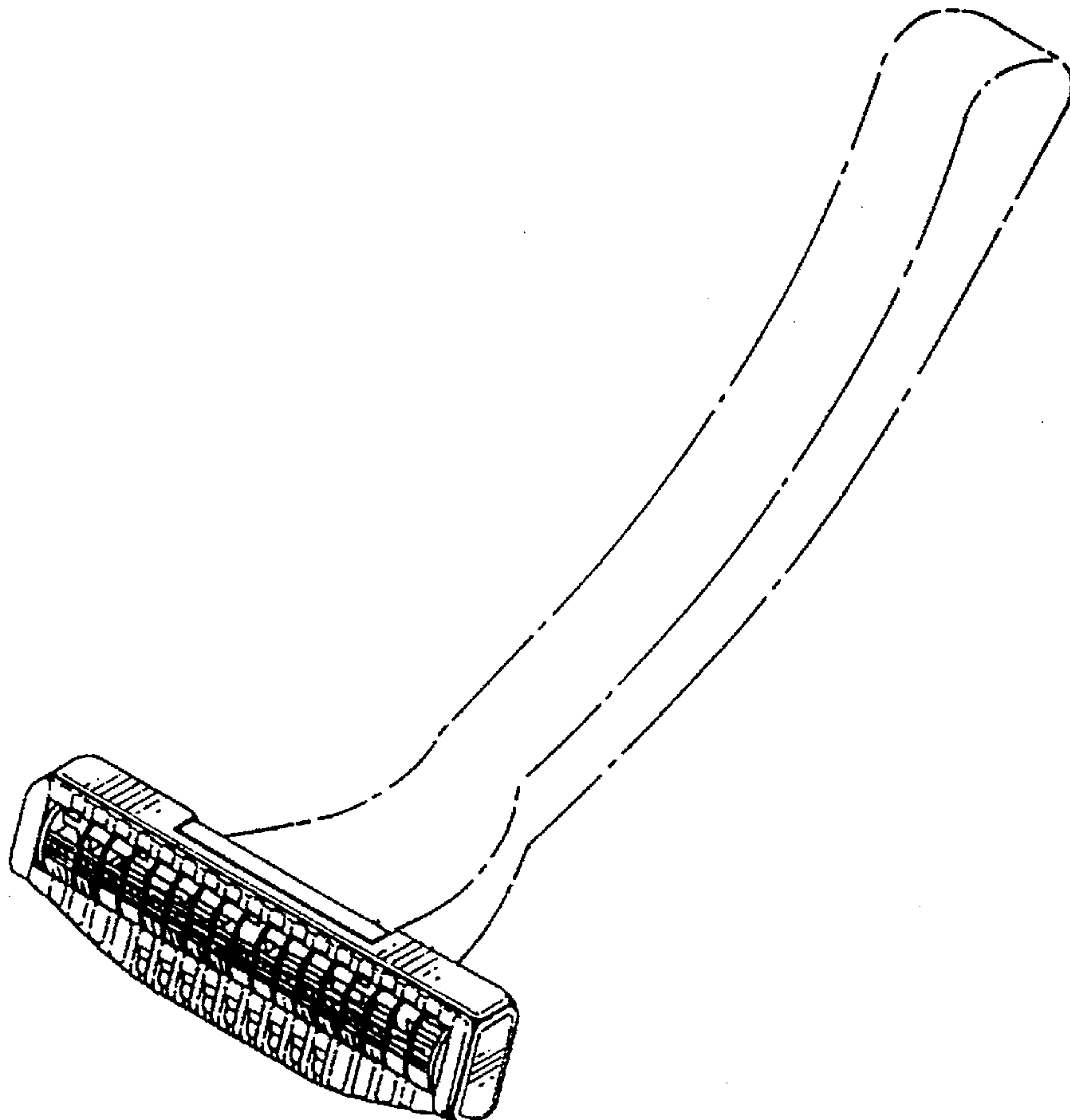

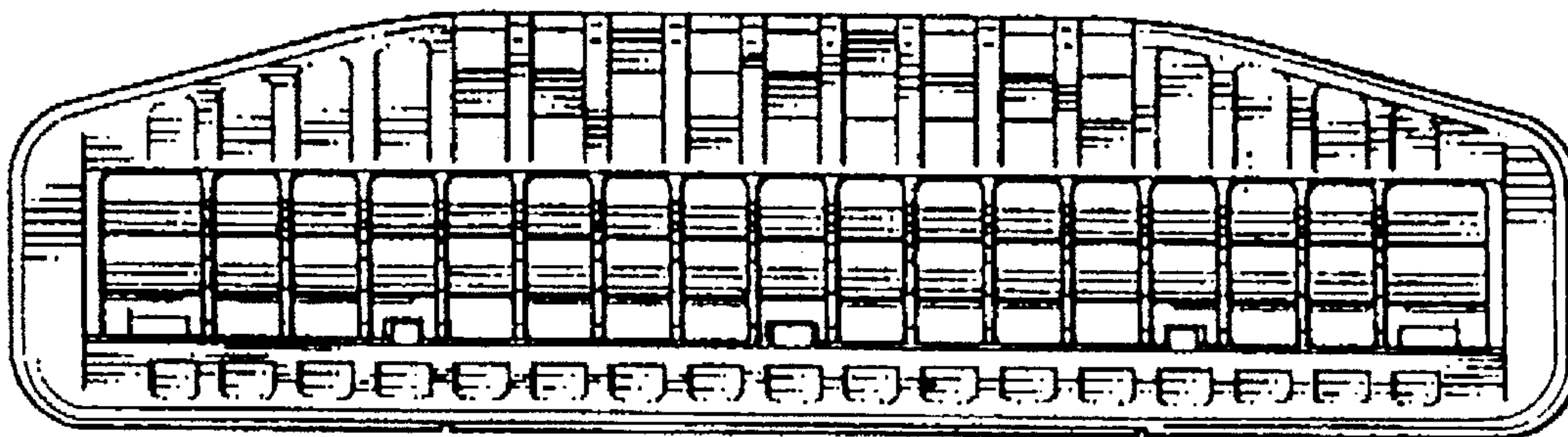

**FIG. 1**

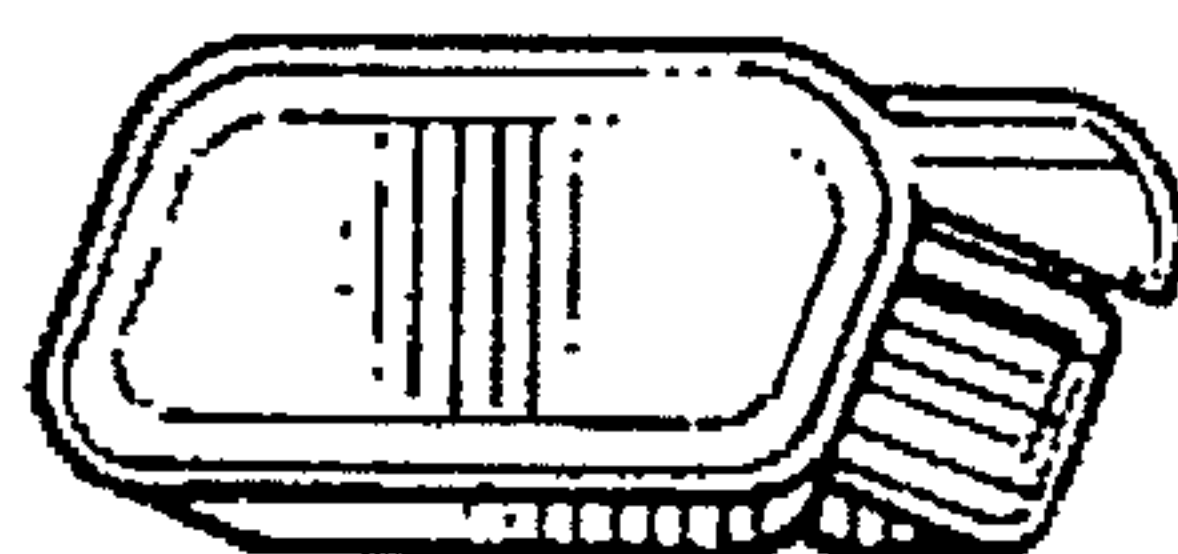

**FIG. 2**



**FIG. 3**

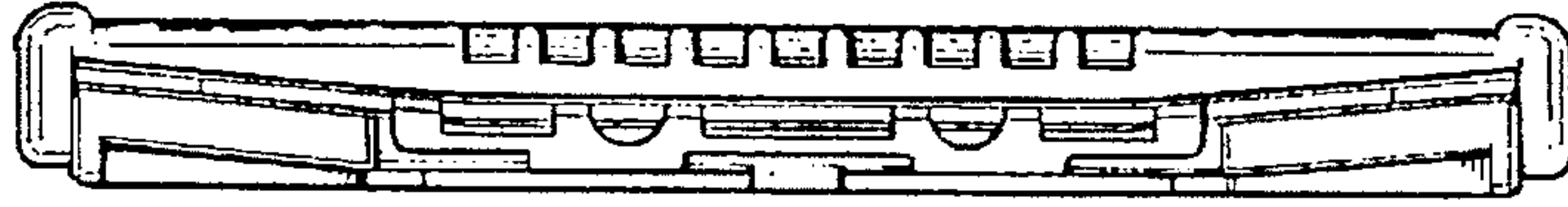

FIG. 4

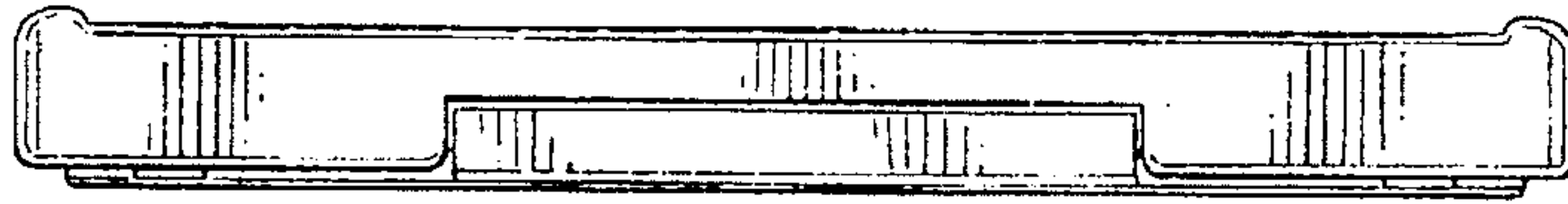

FIG. 5

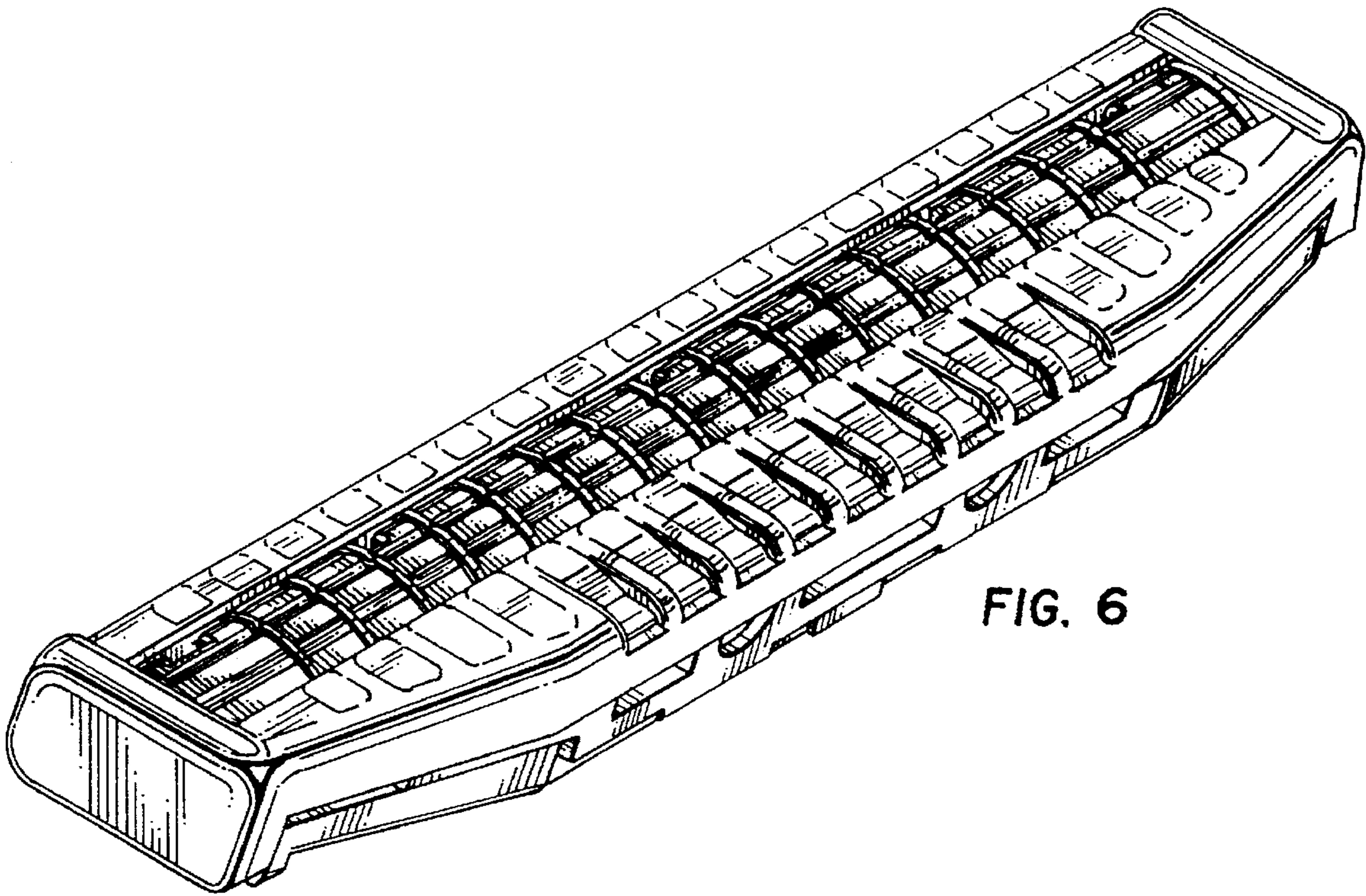

FIG. 6

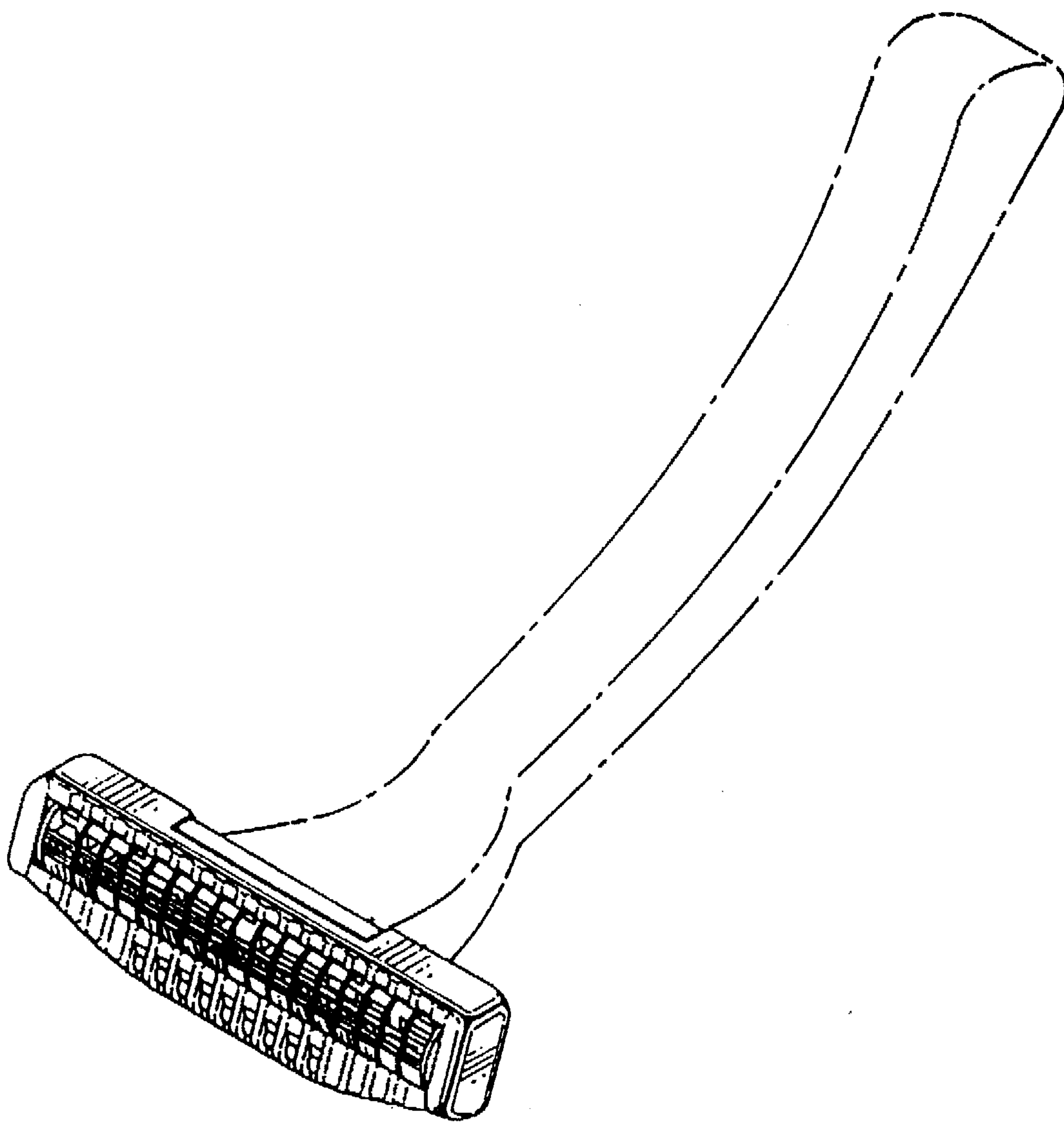

FIG. 7