



US00D379668S

# United States Patent [19]

Karanikas

[11] Patent Number: Des. 379,668

[45] Date of Patent: \*\*Jun. 3, 1997

[54] **TRANSITION UNIT FOR A RETAINING WALL HAVING IRREGULAR STONEWORK**

[76] Inventor: **Terry Karanikas**, P.O. Box 4621, Queensbury, N.Y. 12804

[\*\*] Term: **14 Years**

[21] Appl. No.: **51,040**

[22] Filed: **Feb. 28, 1996**

[51] LOC (6) Cl. .... **25-01**

[52] U.S. Cl. .... **D25/113**

[58] Field of Search ..... D25/113-118; D21/108, 114; 52/604, 605, 606, 592.1, 592.2, 592.3, 592.6, 314, 311.1, 456; 446/110, 111, 119-122, 124-125, 128

### References Cited

#### U.S. PATENT DOCUMENTS

D. 124,533	1/1941	Lebecque	.....	D25/113
D. 297,767	9/1988	Forsberg	.....	D25/114
D. 306,489	3/1990	Karanikas	.....	D25/113
723,175	3/1903	Meyers	.....	52/606
1,809,504	6/1931	Carvel	.....	52/314

1,879,311	9/1932	Keuls	.....	52/604
2,449,458	9/1948	Dryden	.....	52/592.6
2,578,600	12/1951	Rose	.....	52/605
2,819,495	1/1958	Krausz	.....	52/314
3,659,358	5/1972	Brown	.....	446/110
5,257,880	11/1993	Janopaul, Jr.	.....	52/606

Primary Examiner—Ted Shooman  
Assistant Examiner—R. Barkai  
Attorney, Agent, or Firm—Schmeiser, Olsen & Watts

### [57] CLAIM

The ornamental design for a transition unit for a retaining wall having irregular stonework, as shown.

### DESCRIPTION

FIG. 1 is a top plan view of a transition unit for a retaining wall having irregular stonework showing my new design; FIG. 2 is a left side elevational view thereof; FIG. 3 is a front elevational view thereof; FIG. 4 is a right side elevational view thereof; FIG. 5 is a bottom plan view thereof; FIG. 6 is a rear elevational view thereof; and, FIG. 7 is an isometric view thereof.

1 Claim, 2 Drawing Sheets

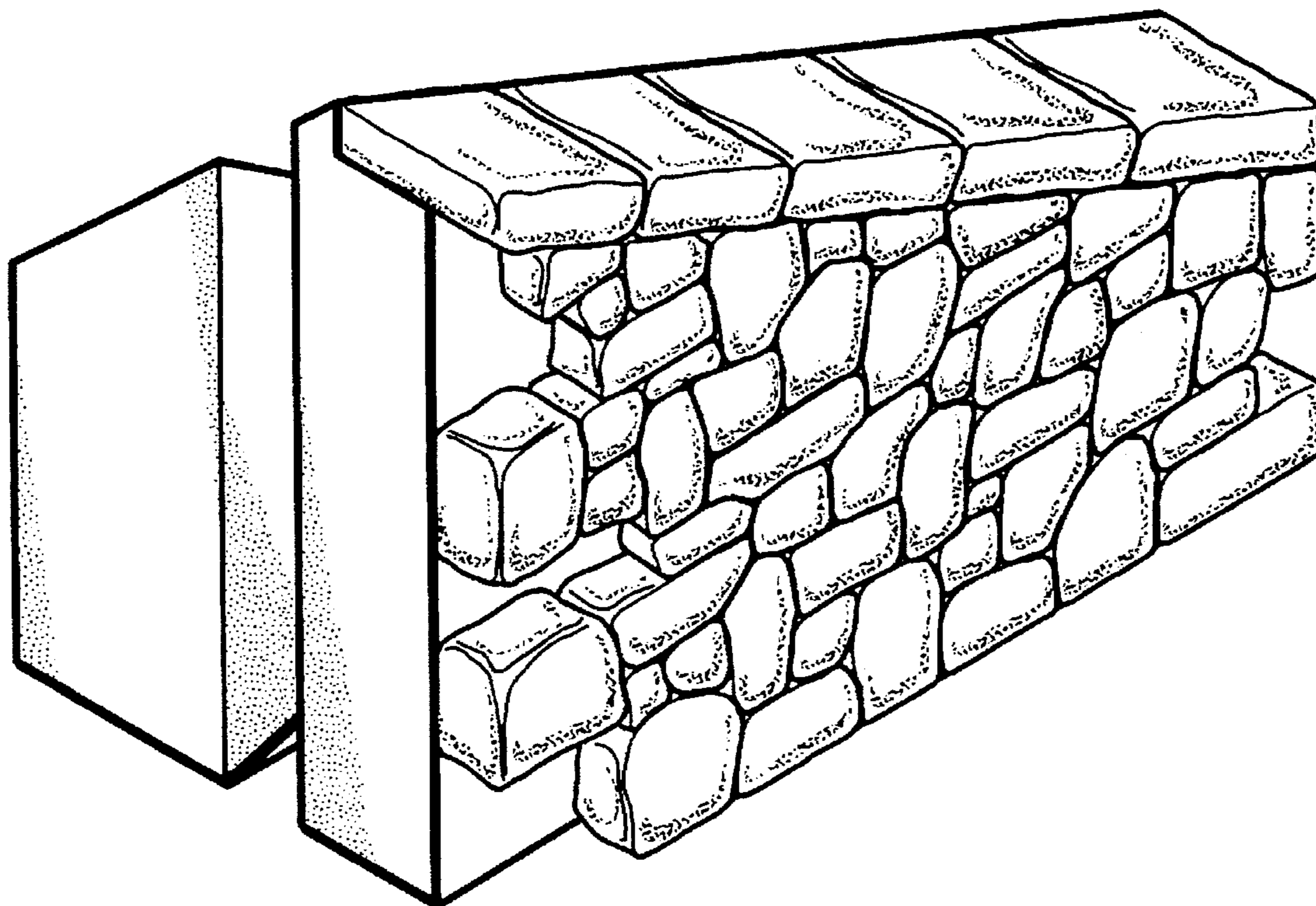

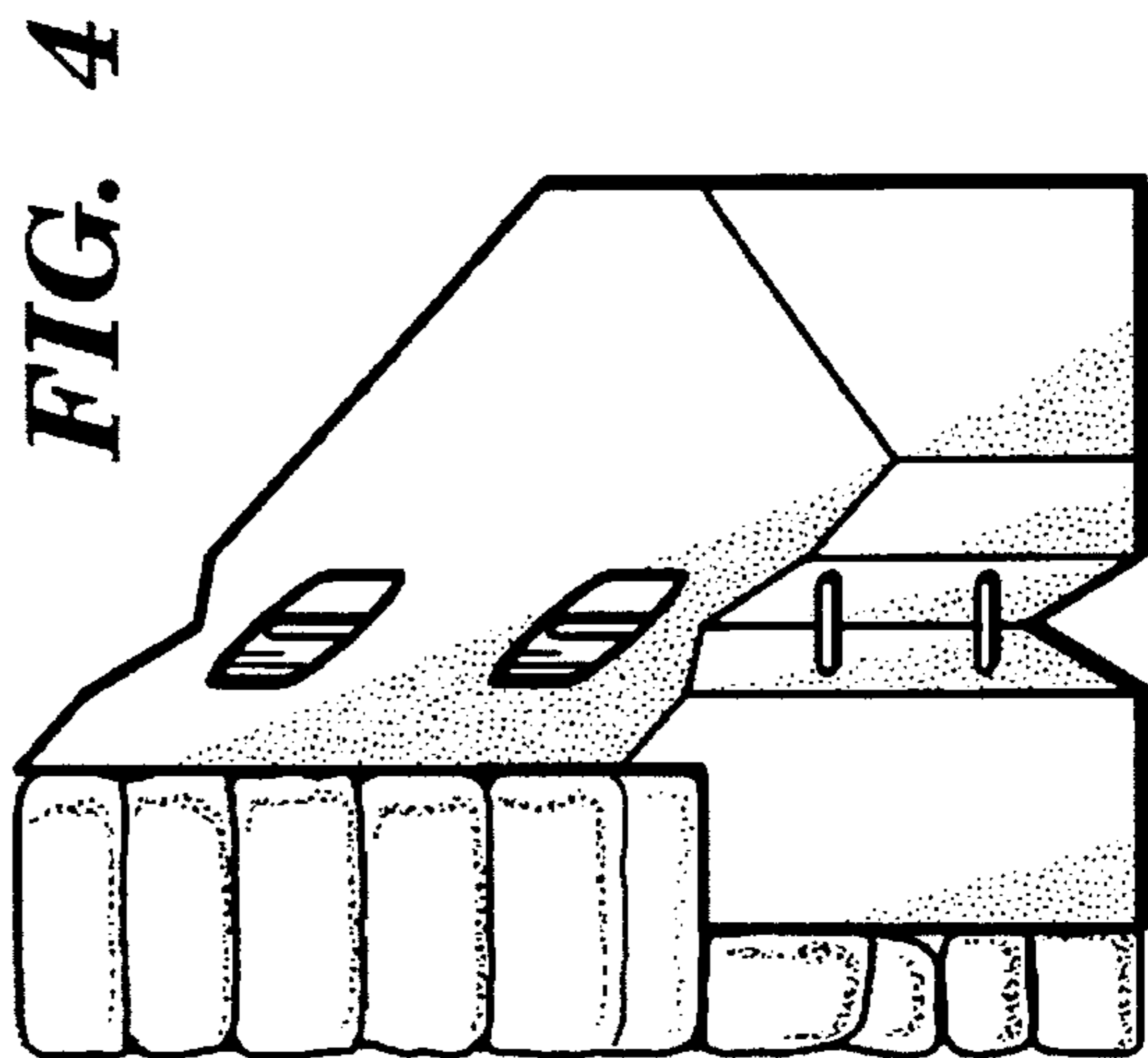
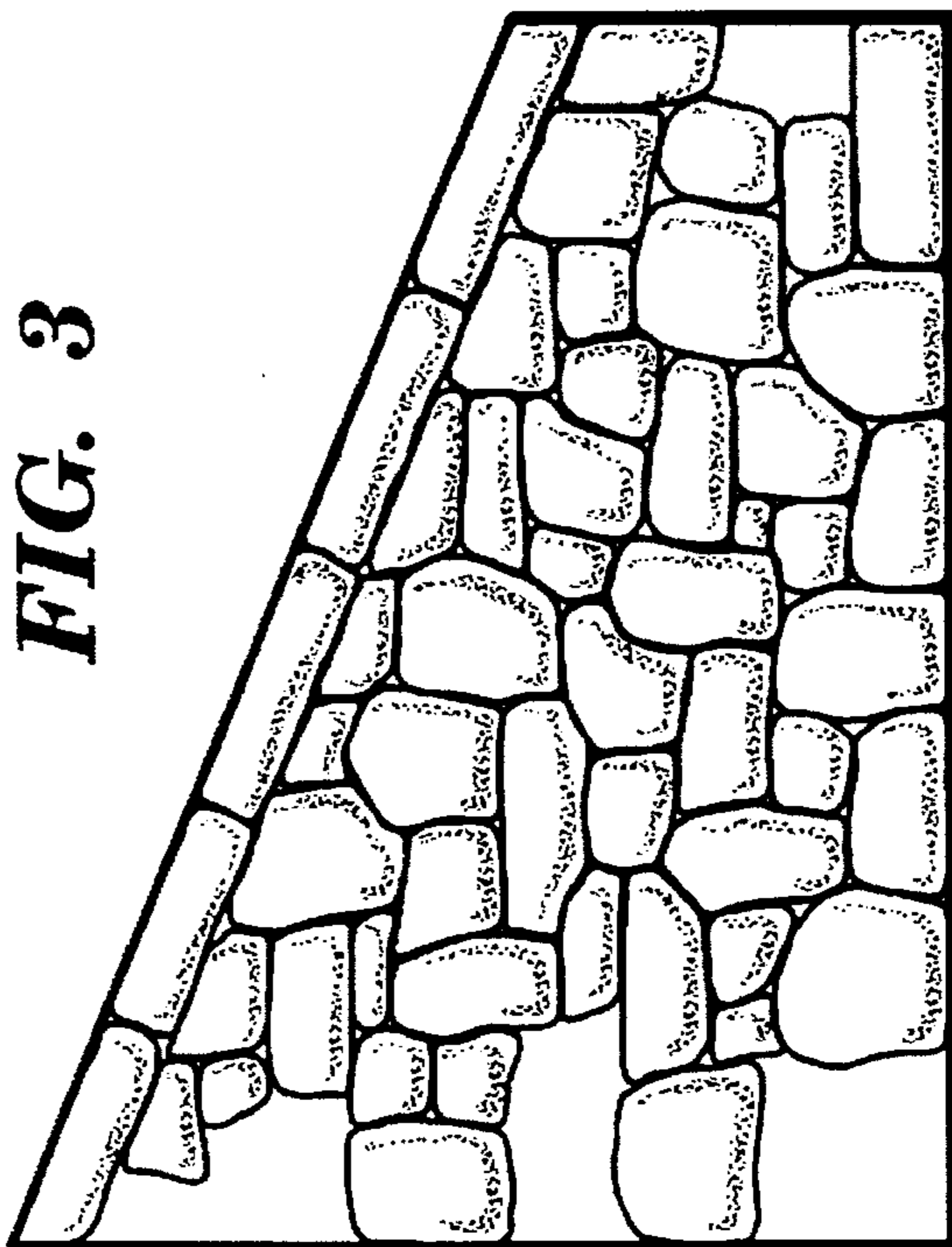
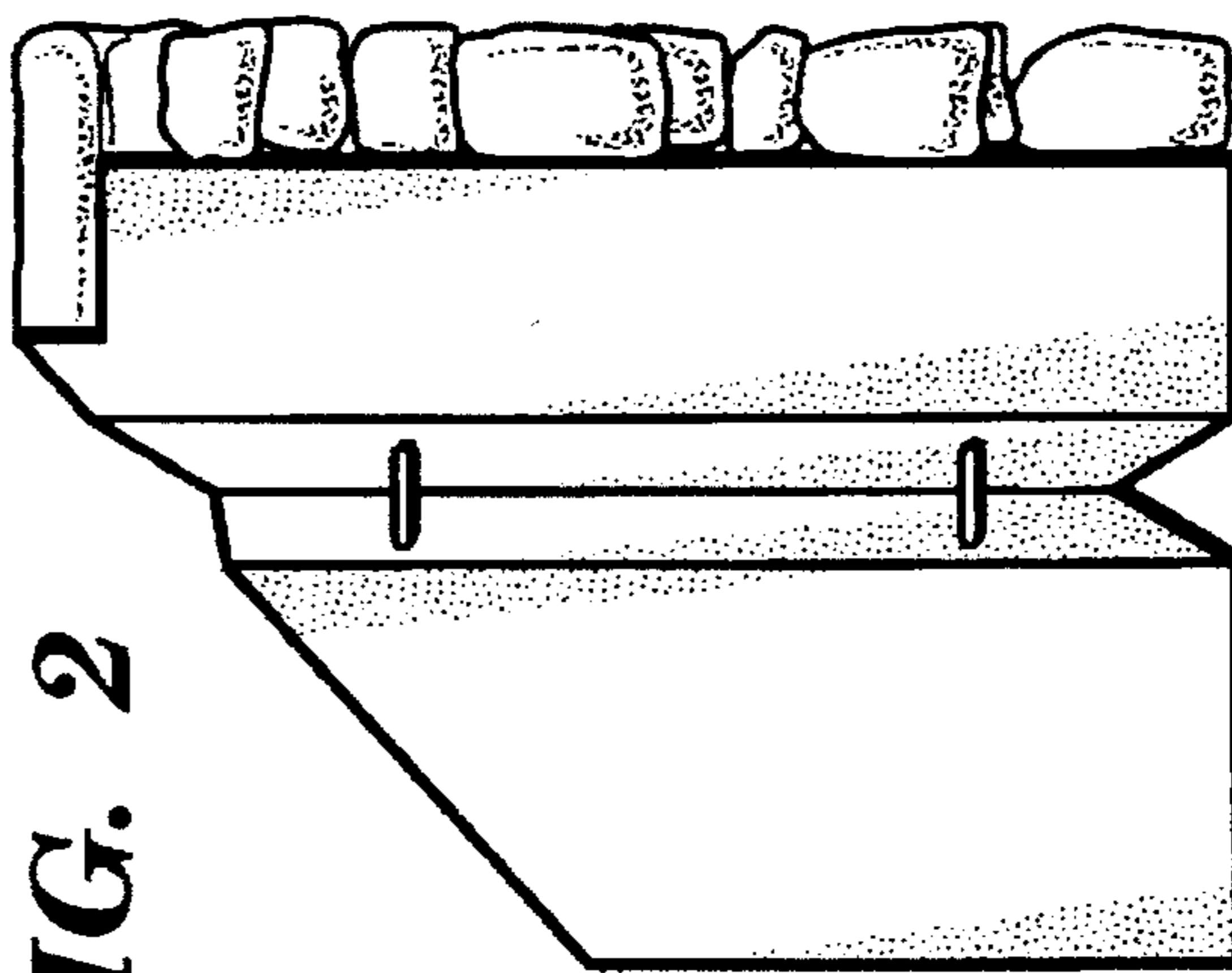
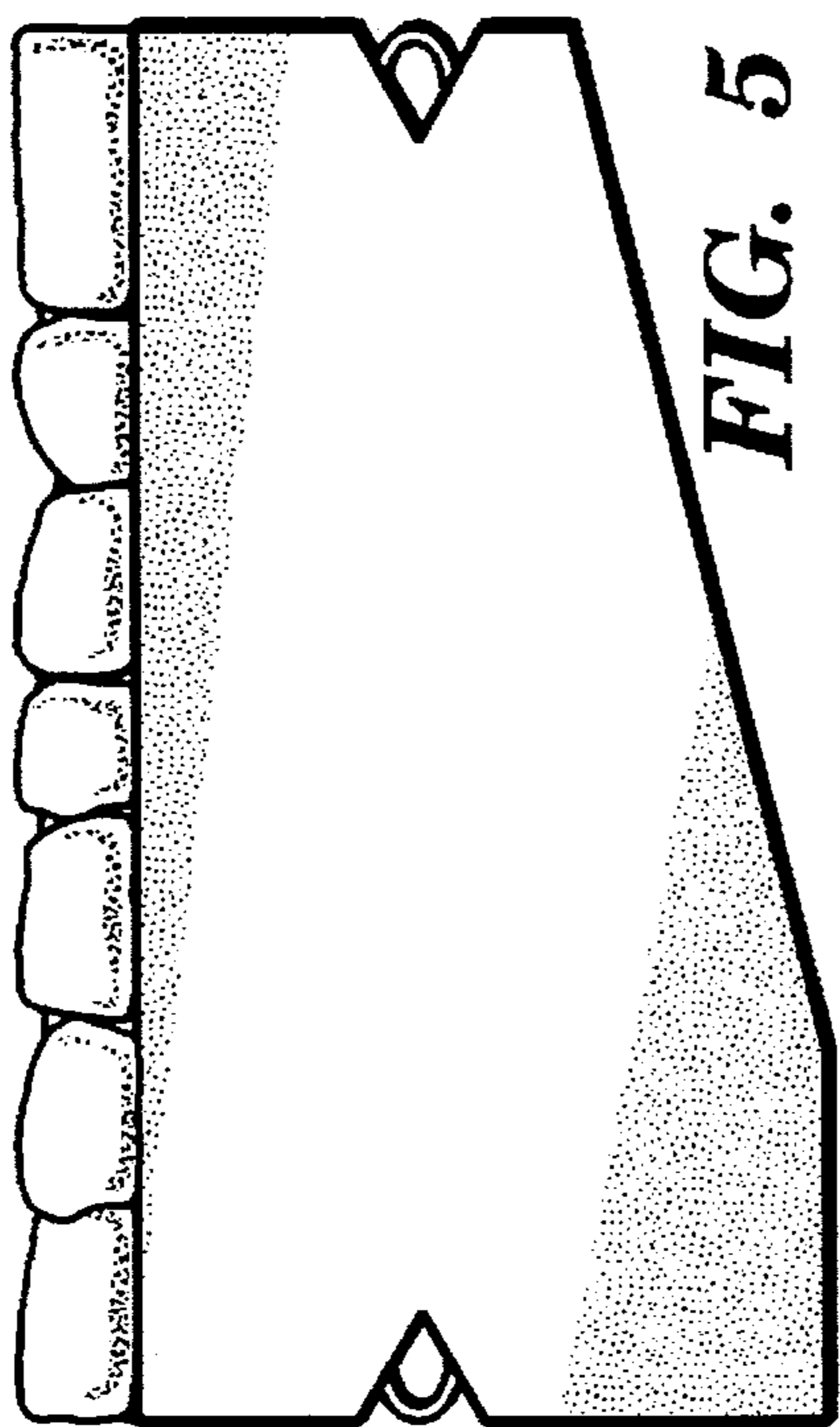
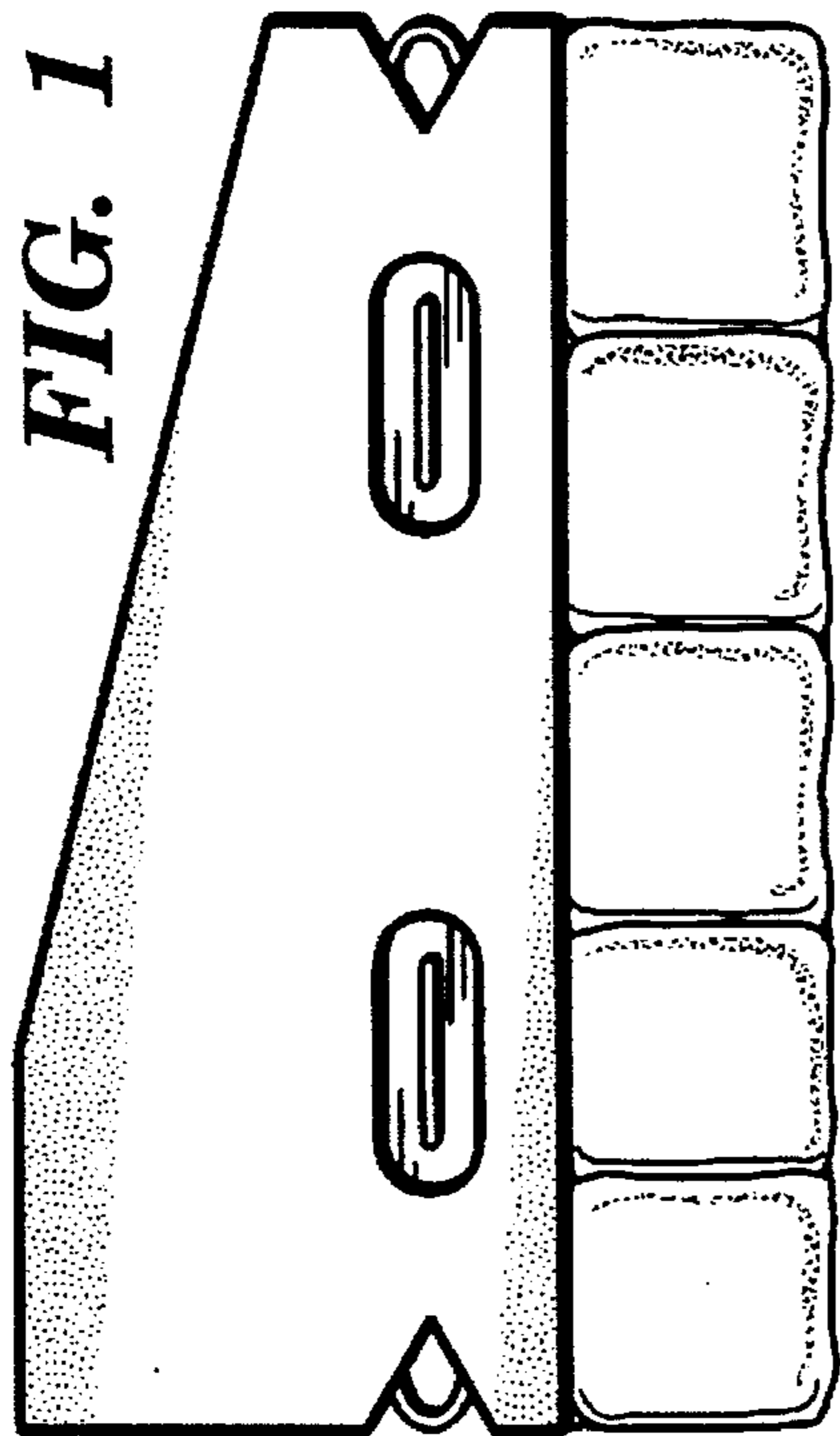

FIG. 2

FIG. 3

FIG. 4

FIG. 1

FIG. 5

**FIG. 6**

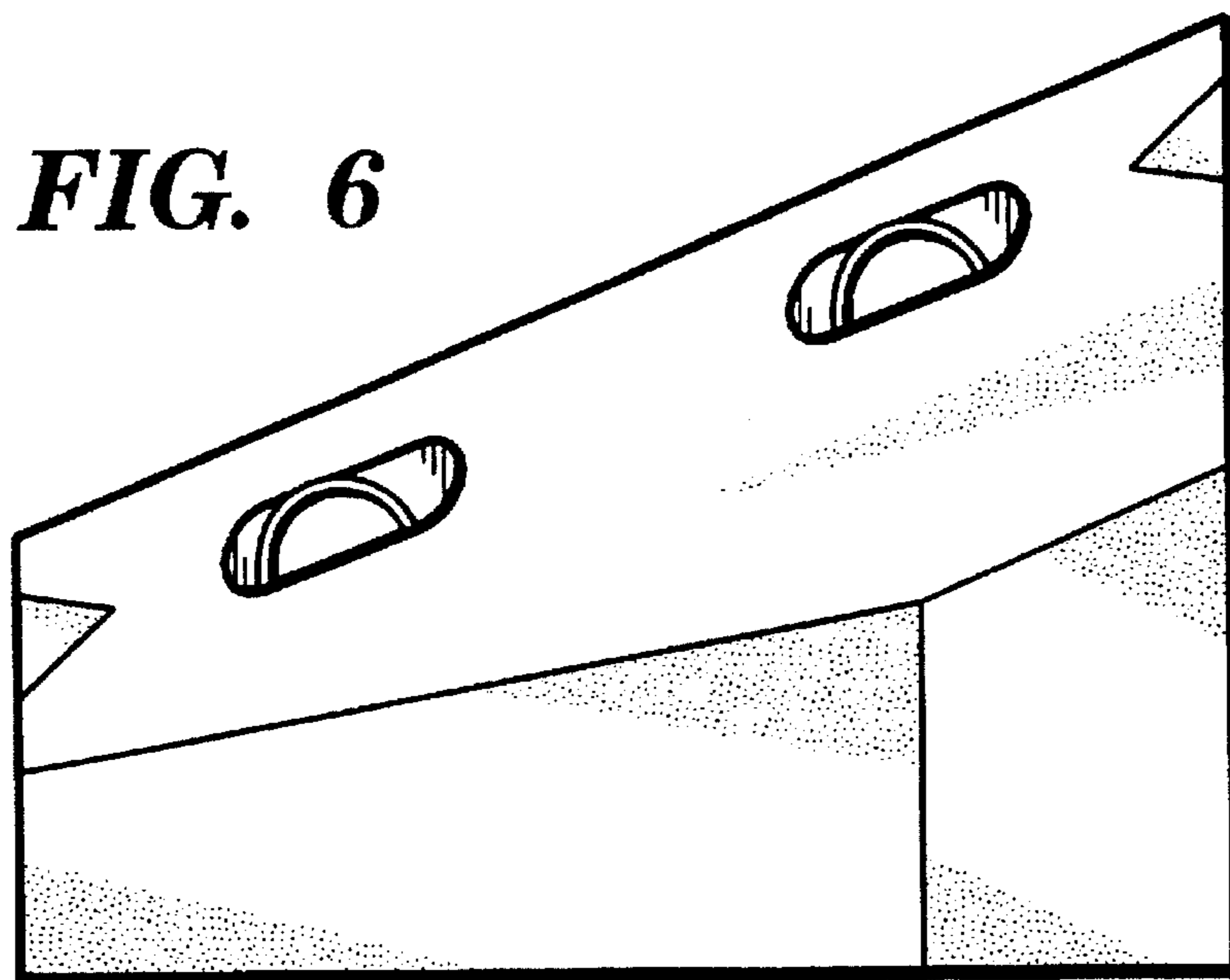

**FIG. 7**

