



US00D379602S

United States Patent [19]
Meixsell

[11] **Patent Number: Des. 379,602**
[45] **Date of Patent: **Jun. 3, 1997**

[54] **PORTABLE GREENHOUSE**

1,558,357 10/1925 Henley D11/156 X

[76] **Inventor: Arthur Meixsell, 2386 Circle Dr., O Fallon, Mo. 63366-6526**

Primary Examiner—James Gandy
Assistant Examiner—Caron D. Veynar

[**] **Term: 14 Years**

[57] **CLAIM**

[21] **Appl. No.: 44,753**

The ornamental design for a portable greenhouse, as shown and described.

[22] **Filed: Sep. 29, 1995**

DESCRIPTION

[51] **LOC (6) Cl. 11-02**

[52] **U.S. Cl. D11/155; D11/143**

[58] **Field of Search D11/143-145, D11/155, 156; D6/403, 405, 556; D7/332, 334; 47/17, 18, 19, 28.1, 29, 33, 66, 39, 41.01, 901; 206/423; 248/27.8**

FIG. 1 is a rear elevational view of the portable greenhouse showing my new design;
FIG. 2 is a front elevational view thereof;
FIG. 3 is a left side elevational view thereof;
FIG. 4 is a right side elevational view thereof;
FIG. 5 is a top plan view thereof;
FIG. 6 is a bottom plan view thereof; and,
FIG. 7 is sectional view taken vertically through the mid-plane of the device at line 7—7 of FIG. 5 thereof.

[56] **References Cited**

U.S. PATENT DOCUMENTS

D. 165,998 2/1952 Pollard D7/334
D. 255,863 7/1980 Futch D7/334

1 Claim, 3 Drawing Sheets

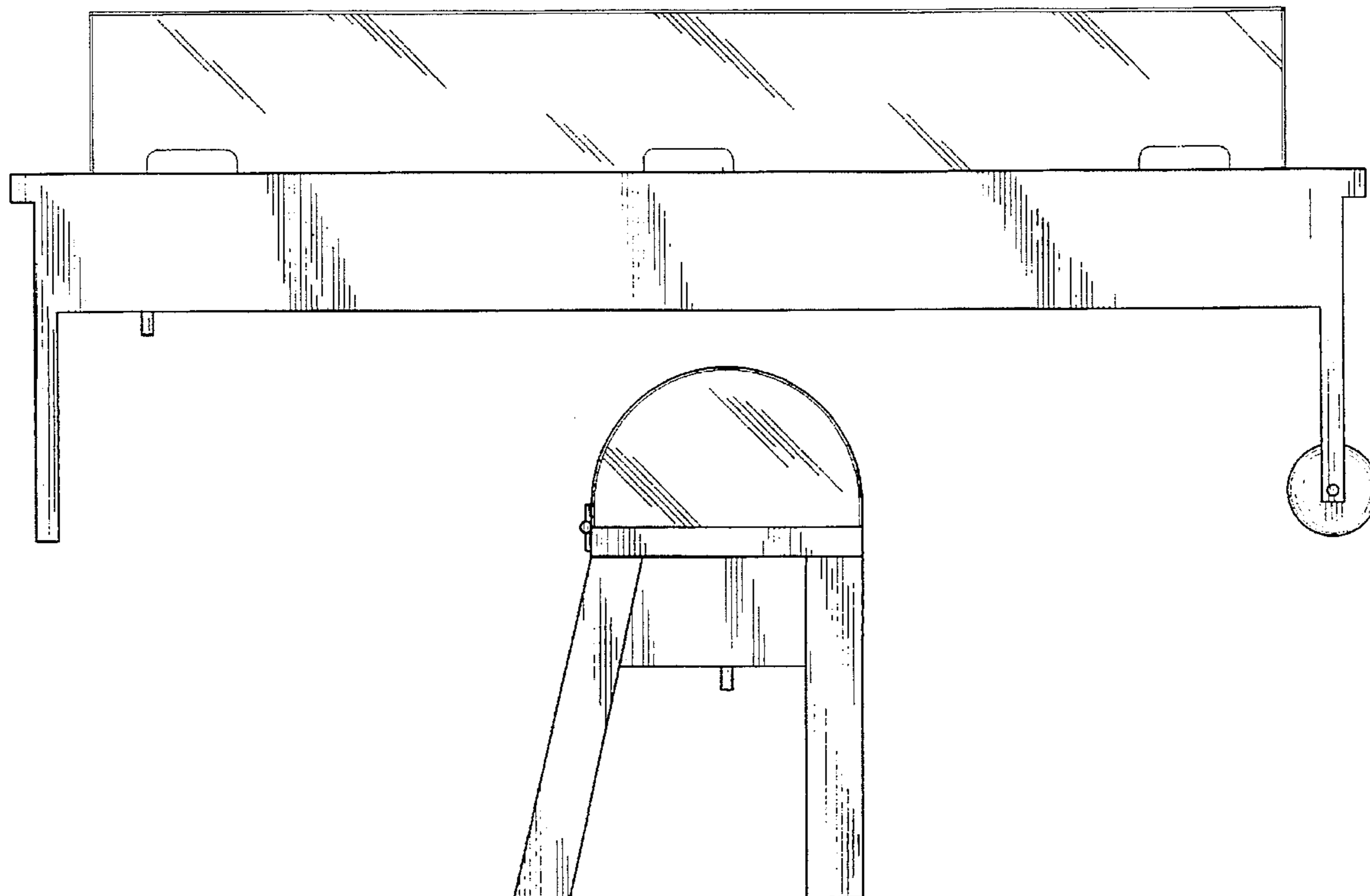

FIG. 1

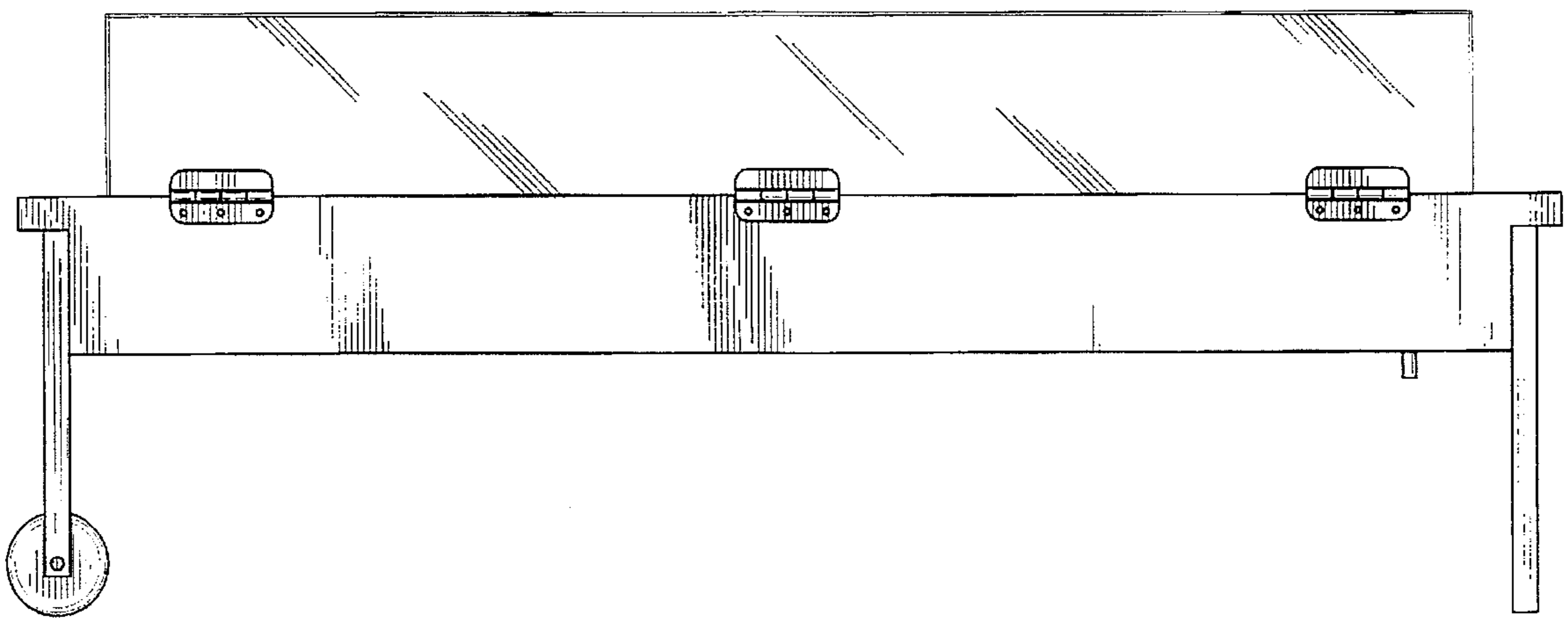

FIG. 2

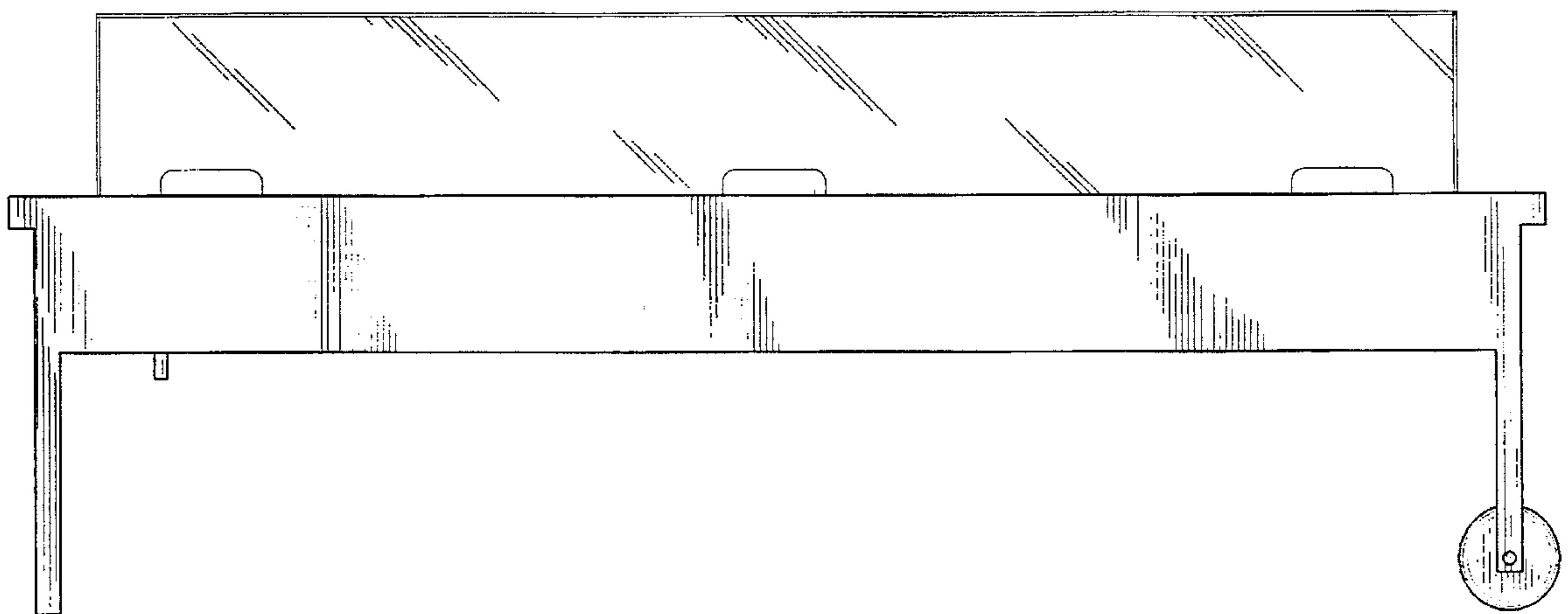

FIG. 3

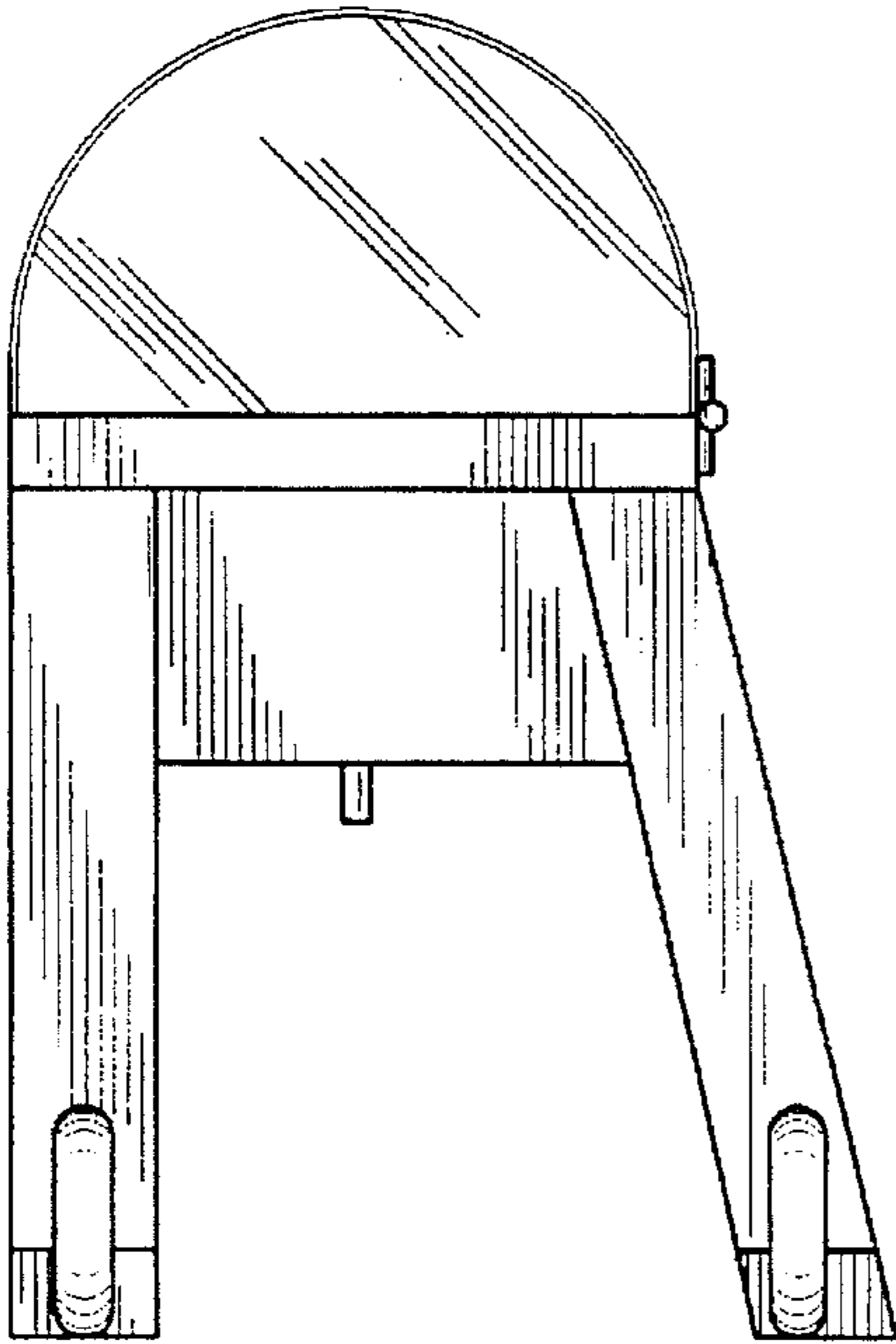

FIG. 4

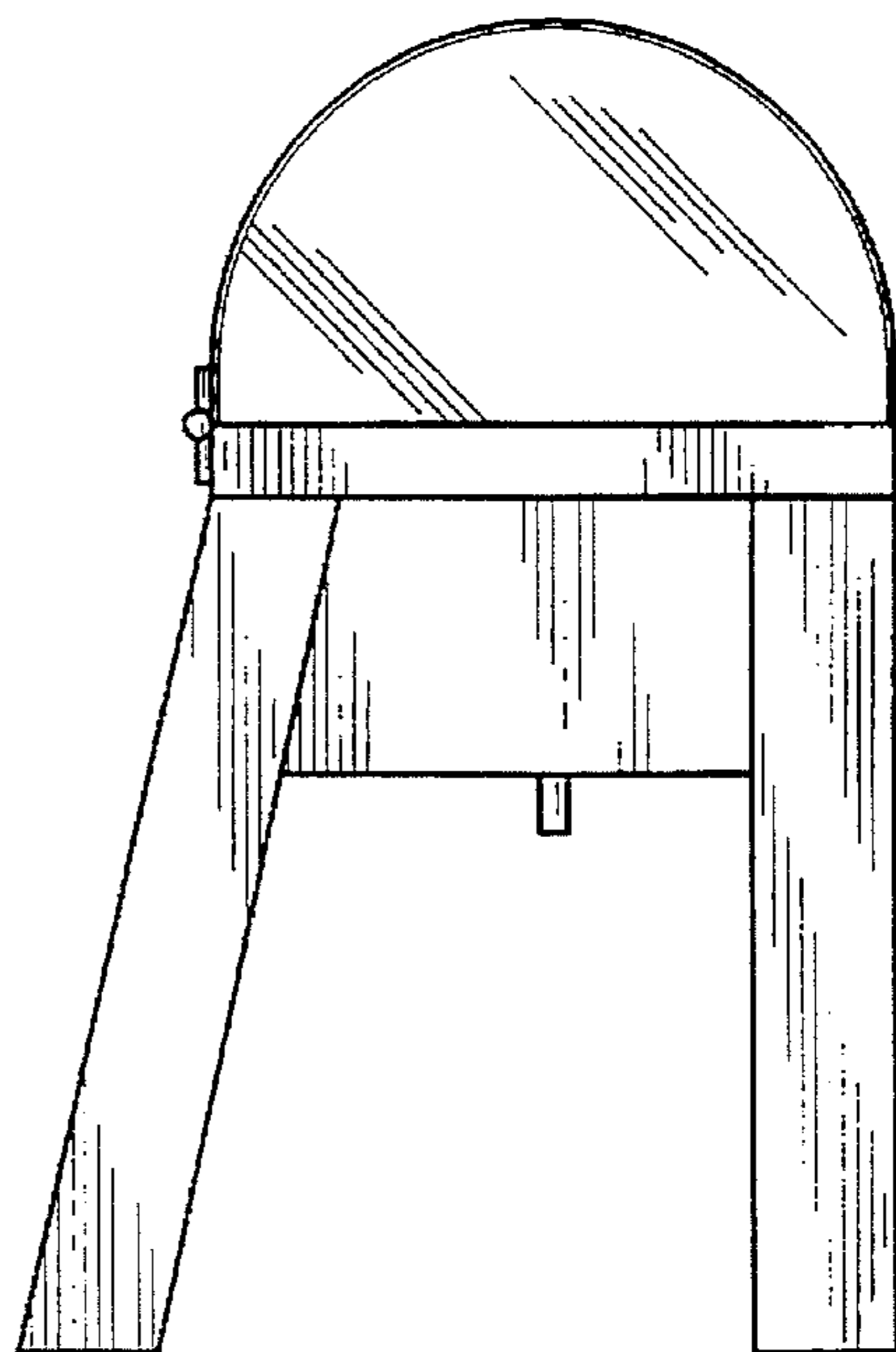

FIG. 5

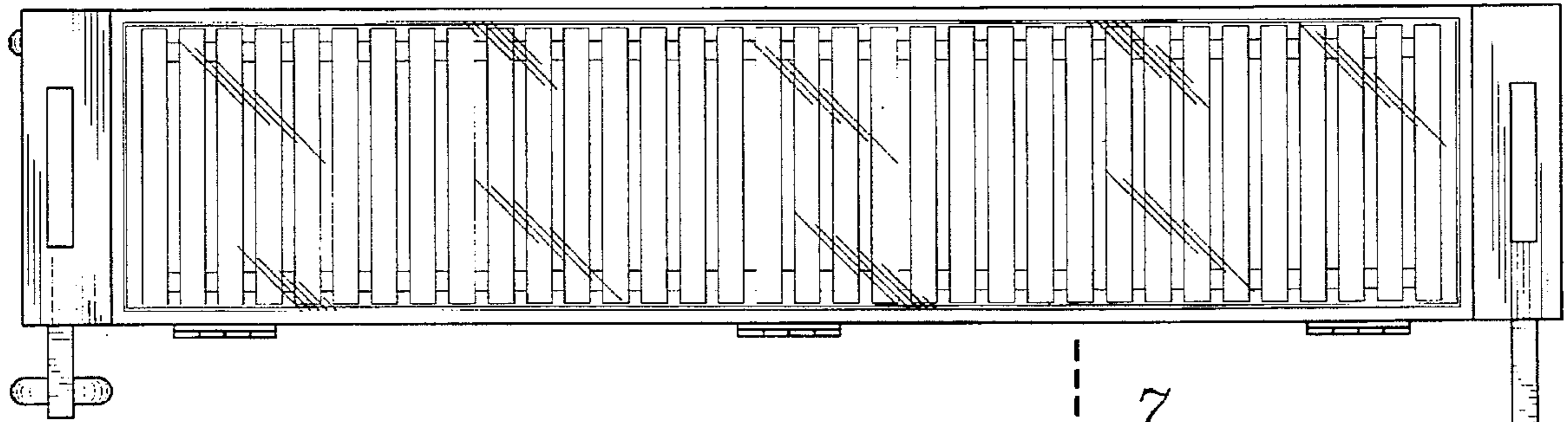

FIG. 6

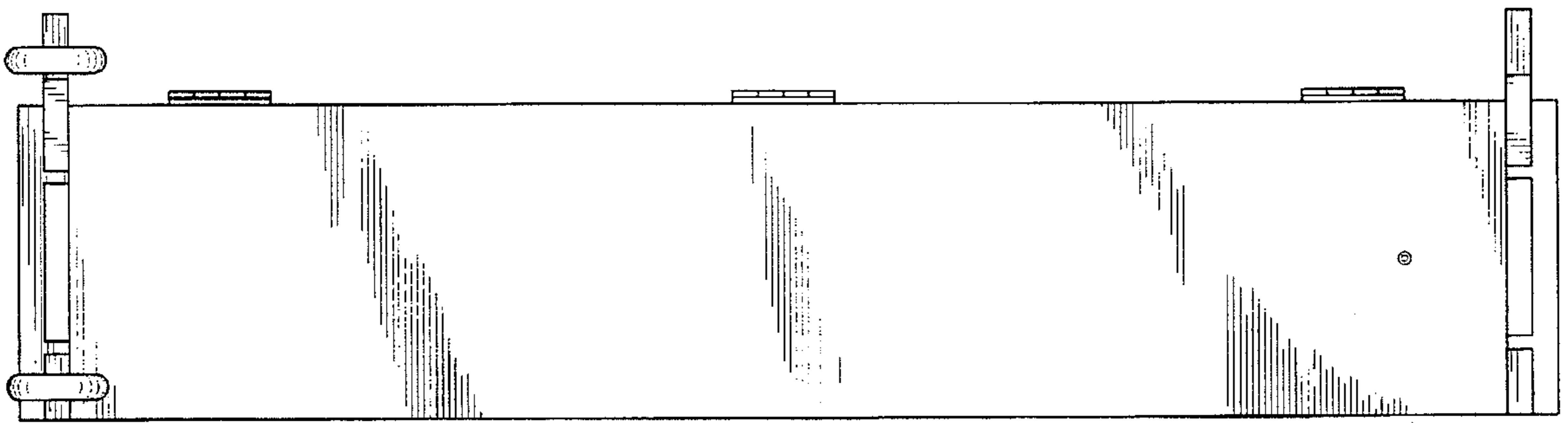

FIG. 7

