



US00D379560S

# United States Patent [19]

Baker et al.

[11] Patent Number: **Des. 379,560**

[45] Date of Patent: **\*\*Jun. 3, 1997**

[54] **FISHING TROUT LINE BOX**

4,827,659 5/1989 Gulley et al. .... 43/57.3  
5,107,618 4/1992 Cummings et al. .... 43/57.3

[76] Inventors: **Eula F. Baker; Arlis R. Baker**, both of  
P.O. Box 24, Vandervoort, Ark. 71972

*Primary Examiner*—Doris V. Coles  
*Assistant Examiner*—Catherine R. Oliver

[\*\*] Term: **14 Years**

### [57] CLAIM

[21] Appl. No.: **42,387**

The ornamental design for a fishing trout line box, as shown and described.

[22] Filed: **Aug. 9, 1995**

### DESCRIPTION

[51] LOC (6) Cl. .... **03-01**

[52] U.S. Cl. .... **D3/905; D3/905**

[58] Field of Search ..... D3/260, 904, 905;  
D21/134, 147; 43/26, 54.1, 57.1, 57.3;  
206/315.1, 315.11, 317; 224/922, 907, 242,  
251, 205, 206

FIG. 1 is a front elevational view of the fishing trout line box showing our new design;  
FIG. 2 is a rear elevational view thereof;  
FIG. 3 is a left side elevational view thereof;  
FIG. 4 is a right side elevational view thereof;  
FIG. 5 is a top plan view thereof;  
FIG. 6 is a bottom plan view thereof;  
FIG. 7 is an cross-sectional view thereof taken along line 7—7 of FIG. 5; and,  
FIG. 8 is a perspective view of the fishing trout line box.

### [56] References Cited

#### U.S. PATENT DOCUMENTS

2,242,509 5/1941 Coalson ..... 43/57.3  
2,816,390 12/1957 Vaughn et al. .... 43/26  
4,525,949 7/1985 Pike et al. .... 43/57.3

**1 Claim, 4 Drawing Sheets**

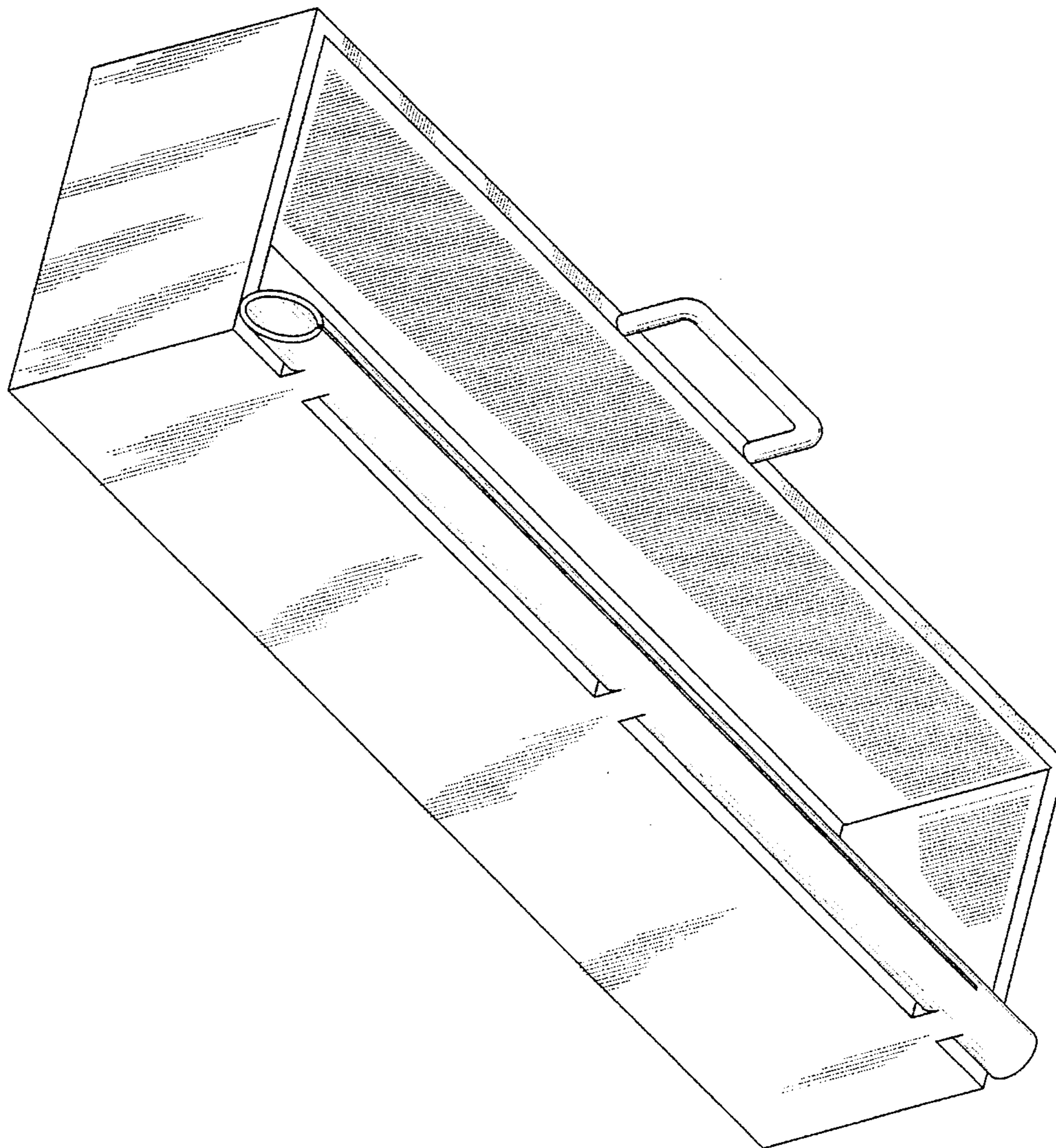

FIG. 1

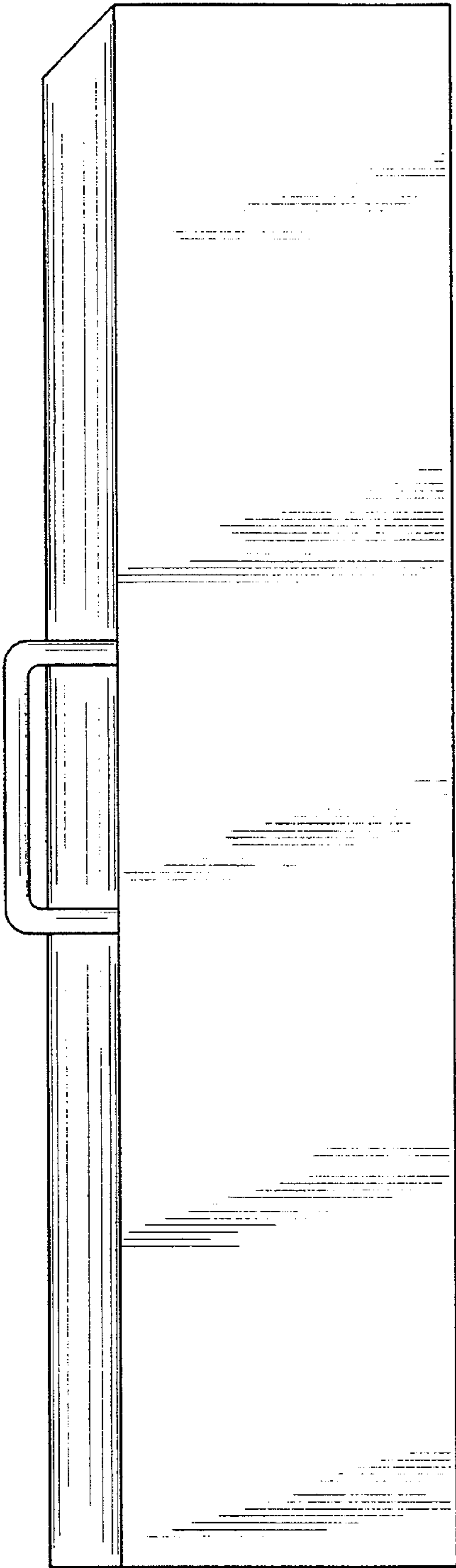

FIG. 2

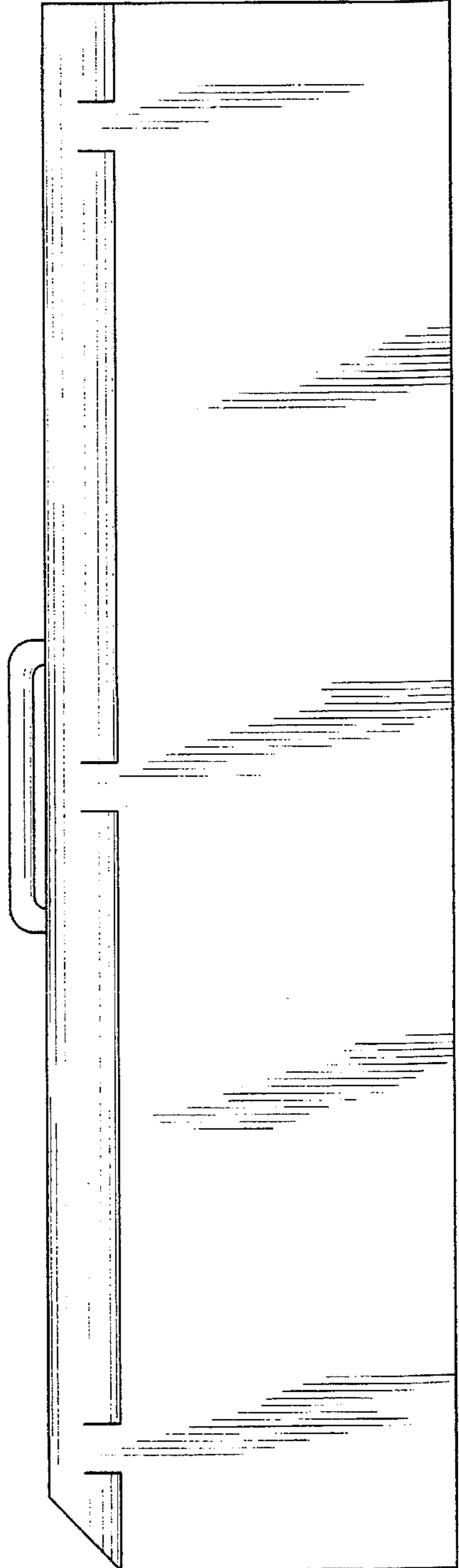

FIG. 4

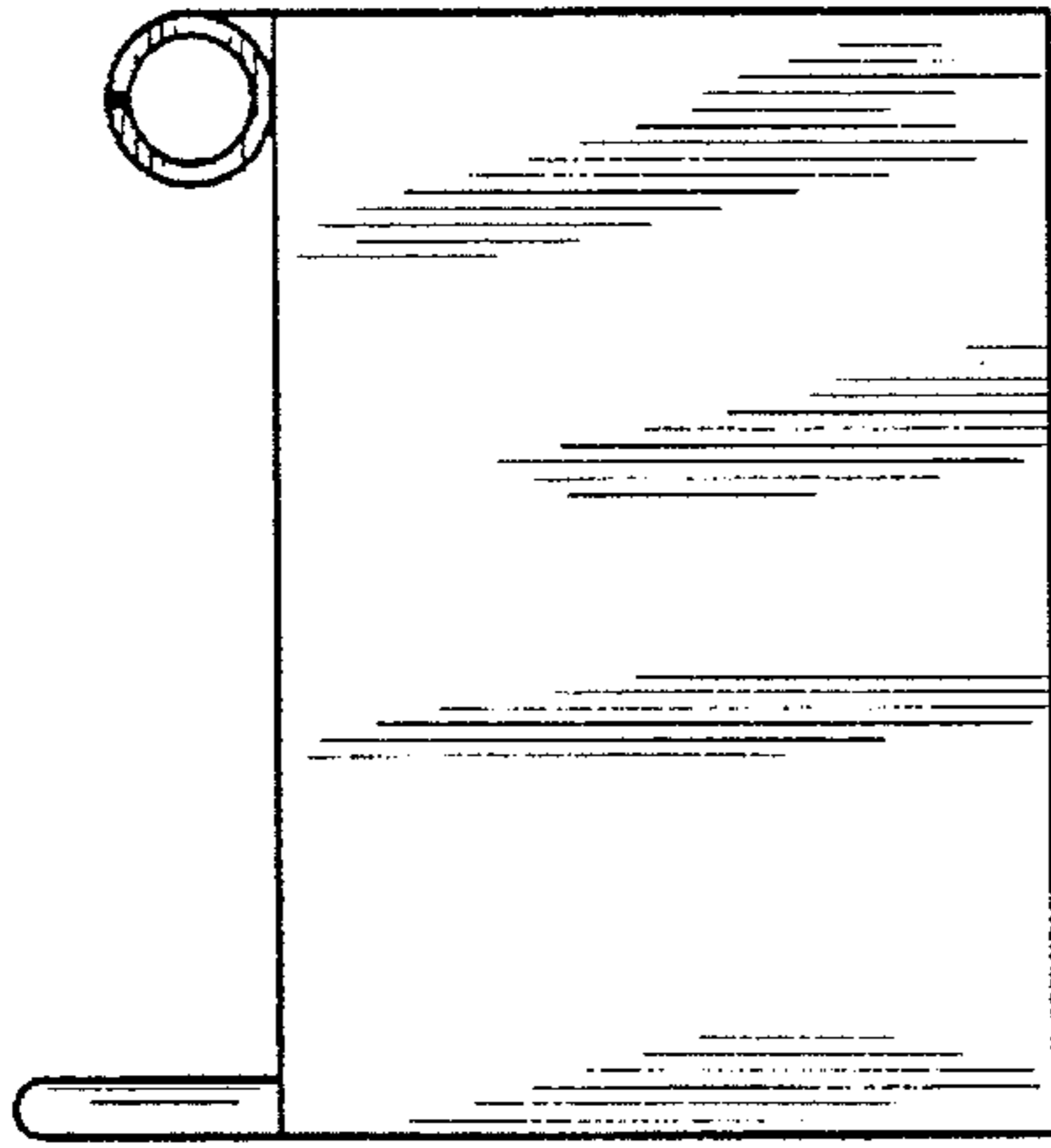

FIG. 3

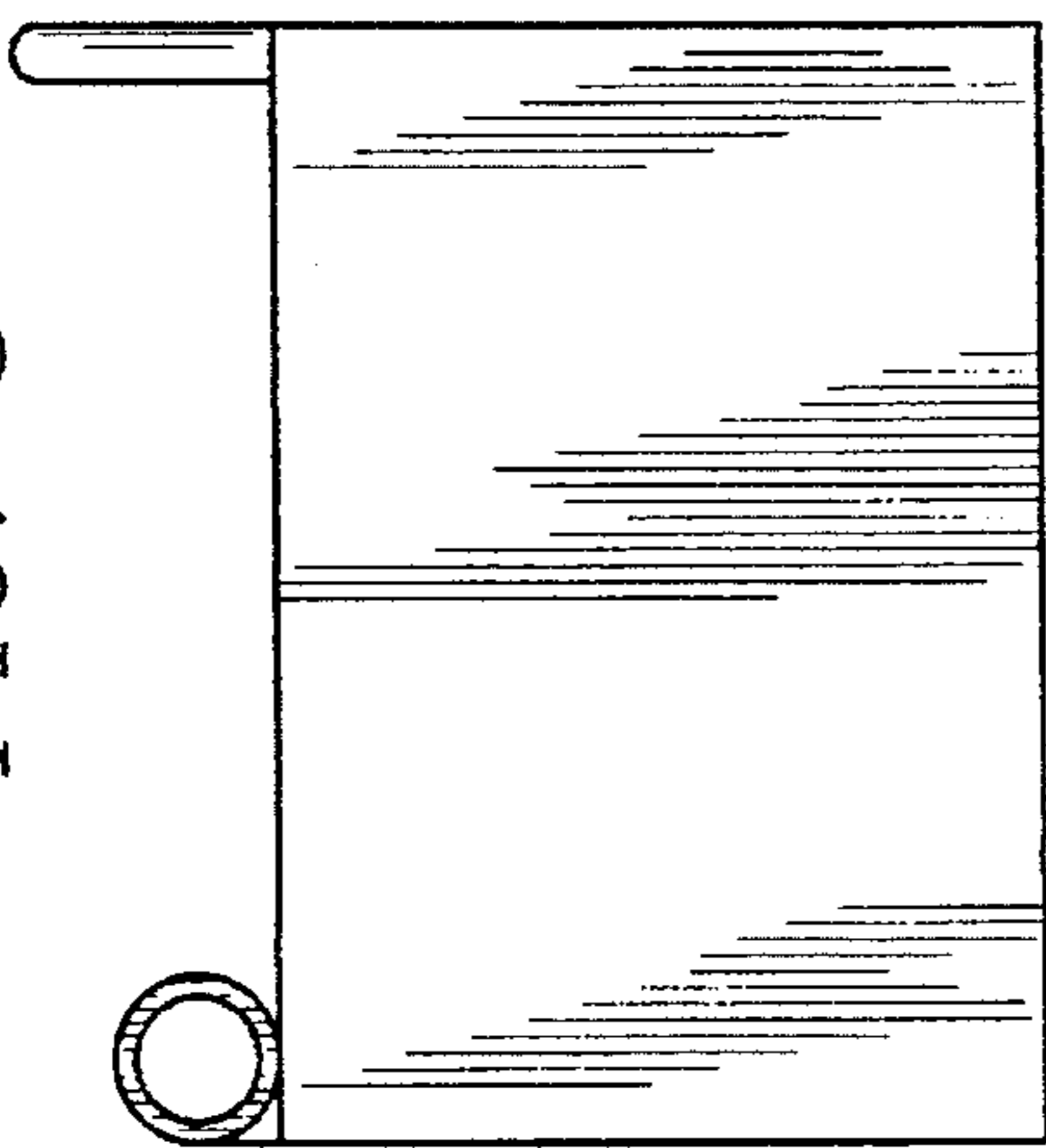

FIG. 5

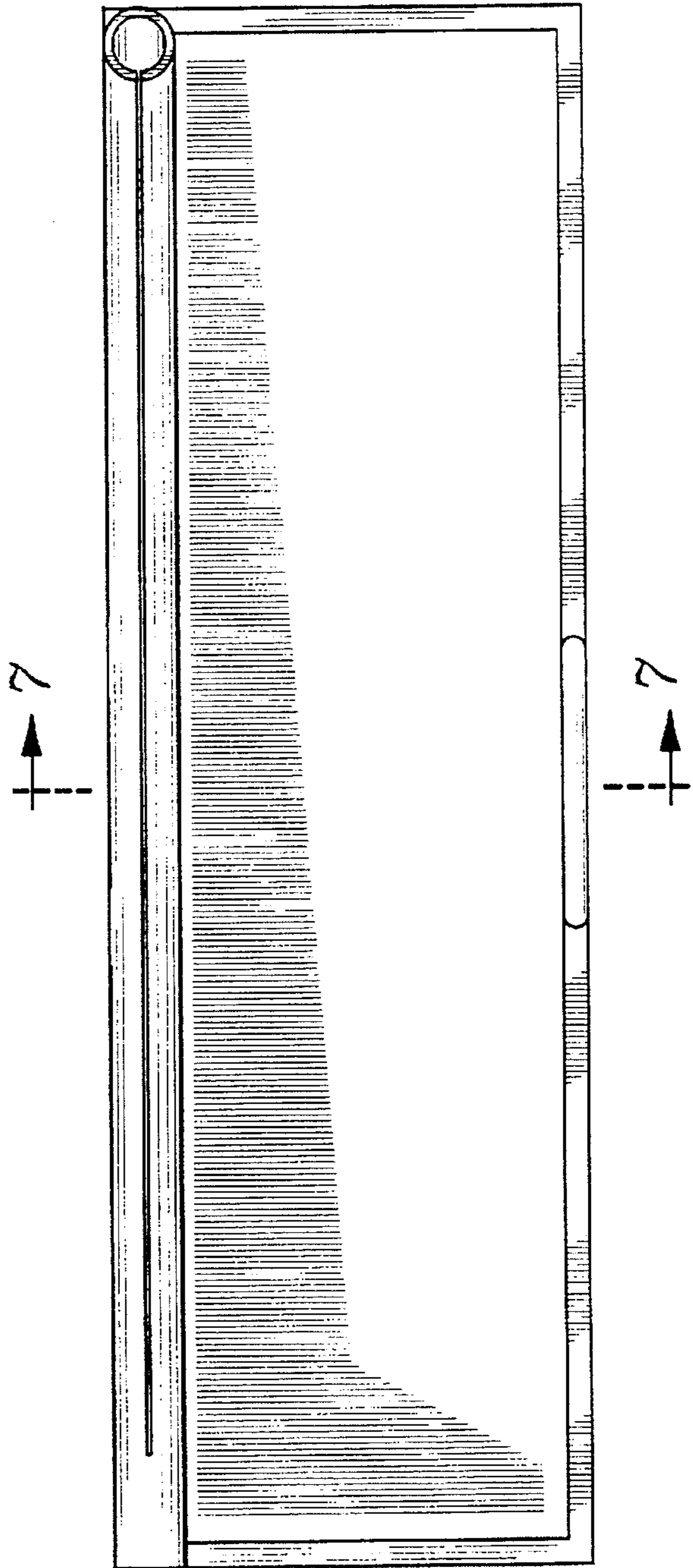

FIG. 6

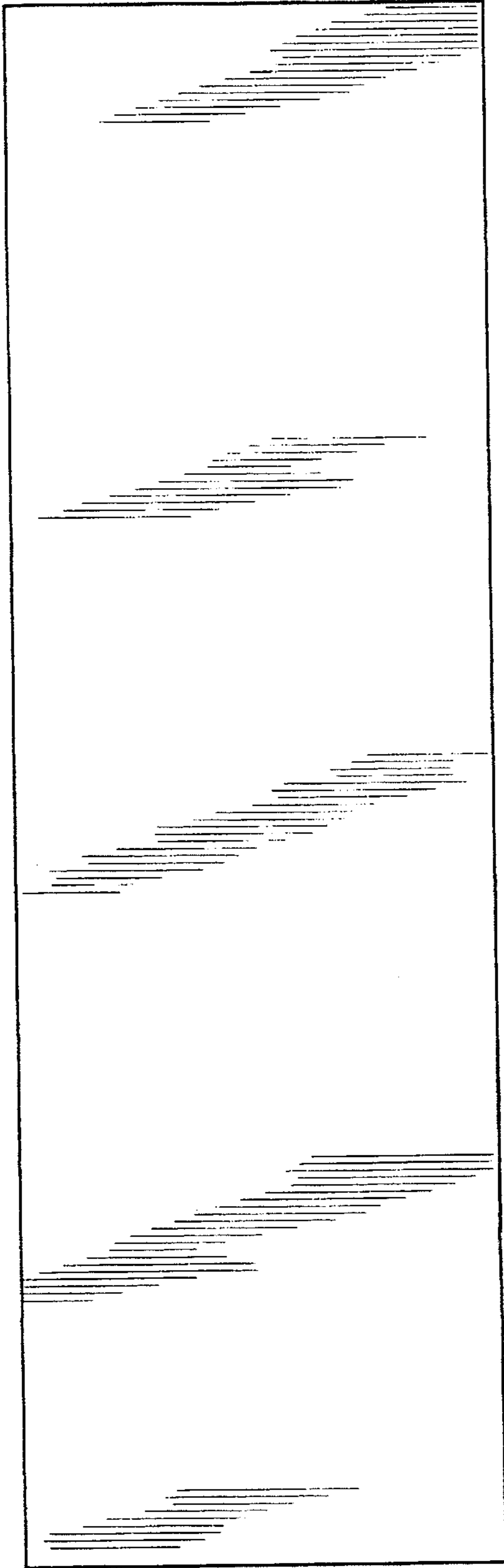

FIG. 7

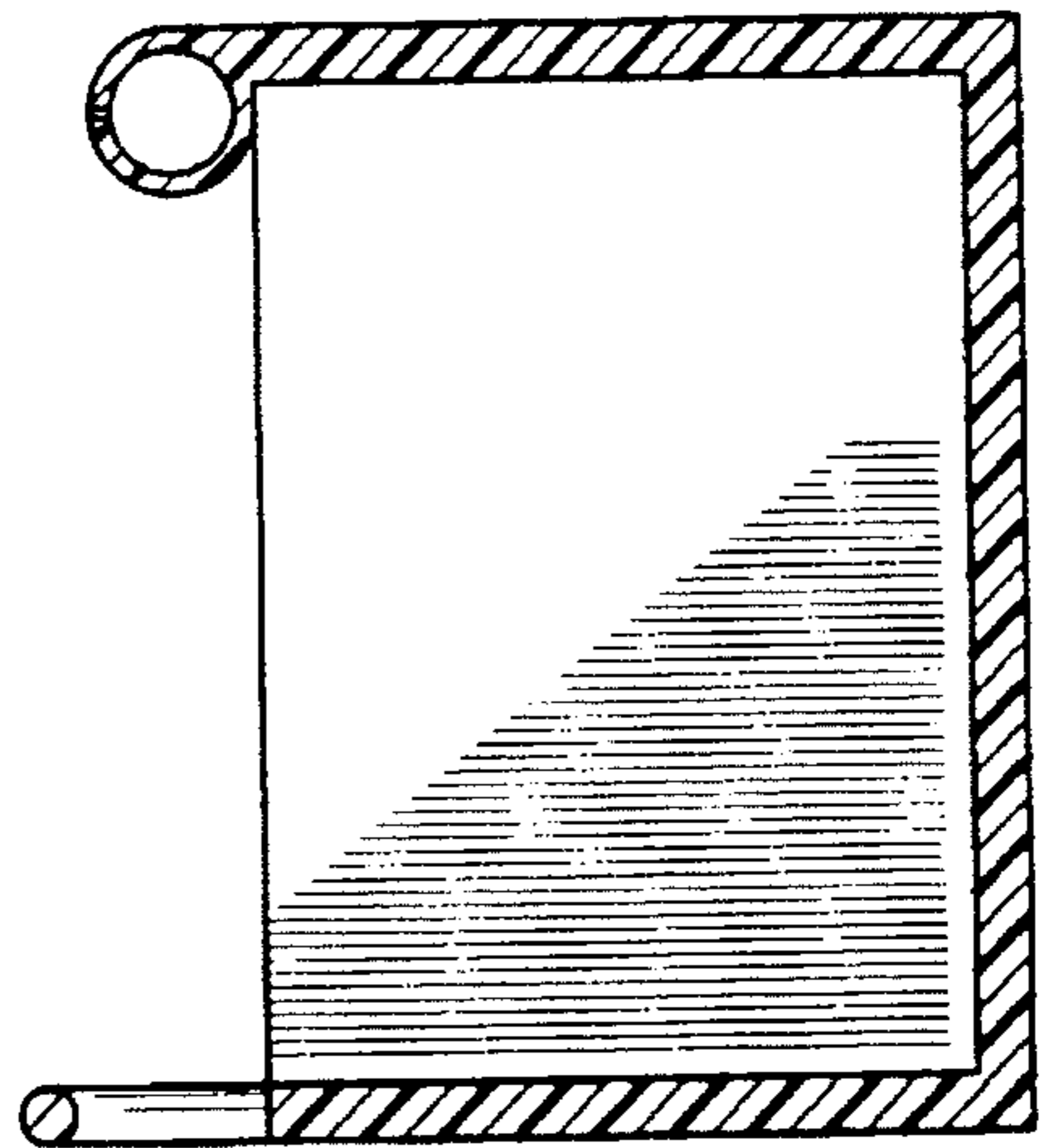



FIG. 8

