



US00D379407S

# United States Patent [19]

Liu

[11] Patent Number: **Des. 379,407**

[45] Date of Patent: **\*\*May 27, 1997**

[54] **BABY STOOL**

[76] Inventor: **Pao-Yu Liu**, 6F., 218, Ta-Tung Rd.,  
Sec. 3, Shi-Chi Chen, Taipei Hsien,  
Taiwan

[\*\*] Term: **14 Years**

[21] Appl. No.: **43,588**

[22] Filed: **Sep. 7, 1995**

[51] LOC (6) Cl. .... **06-01**

[52] U.S. Cl. .... **D6/351; D21/74; D23/297**

[58] **Field of Search** ..... D21/148, 71-81,  
D21/128, 131-140, 164; D12/1, 130; D6/351;  
D23/296, 297; 446/470, 471, 440, 76, 78,  
80, 313, 426, 428; 280/87.01, 87.021, 87.051,  
1.22, 1.13, 827, 828

[56] **References Cited**

**U.S. PATENT DOCUMENTS**

- D. 248,683 7/1978 Nakao et al. .... D21/74
- D. 252,652 8/1979 Nakao et al. .... D21/74
- D. 253,710 12/1979 Nakao et al. .... D21/78

- D. 278,161 3/1985 Benicaso ..... D21/74
- D. 321,046 10/1991 Lambdin ..... D23/297
- D. 351,950 11/1994 Bird et al. .... D6/351
- D. 352,993 11/1994 Boucher et al. .... D23/297
- 2,395,277 2/1946 Kaisler ..... 280/1.22

*Primary Examiner*—Raphael Barkai  
*Attorney, Agent, or Firm*—Bacon & Thomas

[57] **CLAIM**

The ornamental design for a baby stool, as shown and described.

**DESCRIPTION**

FIG. 1 is a rear perspective view of a baby stool, showing my new design;  
FIG. 2 is a front elevation view thereof;  
FIG. 3 is a rear elevational view thereof;  
FIG. 4 is a right side elevational view thereof;  
FIG. 5 is a left side elevational view thereof;  
FIG. 6 is a top plan view thereof;  
FIG. 7 is a bottom plan view thereof; and,  
FIG. 8 is a rear perspective view thereof, the interior element has been shown separately for ease of illustration only.

**1 Claim, 8 Drawing Sheets**

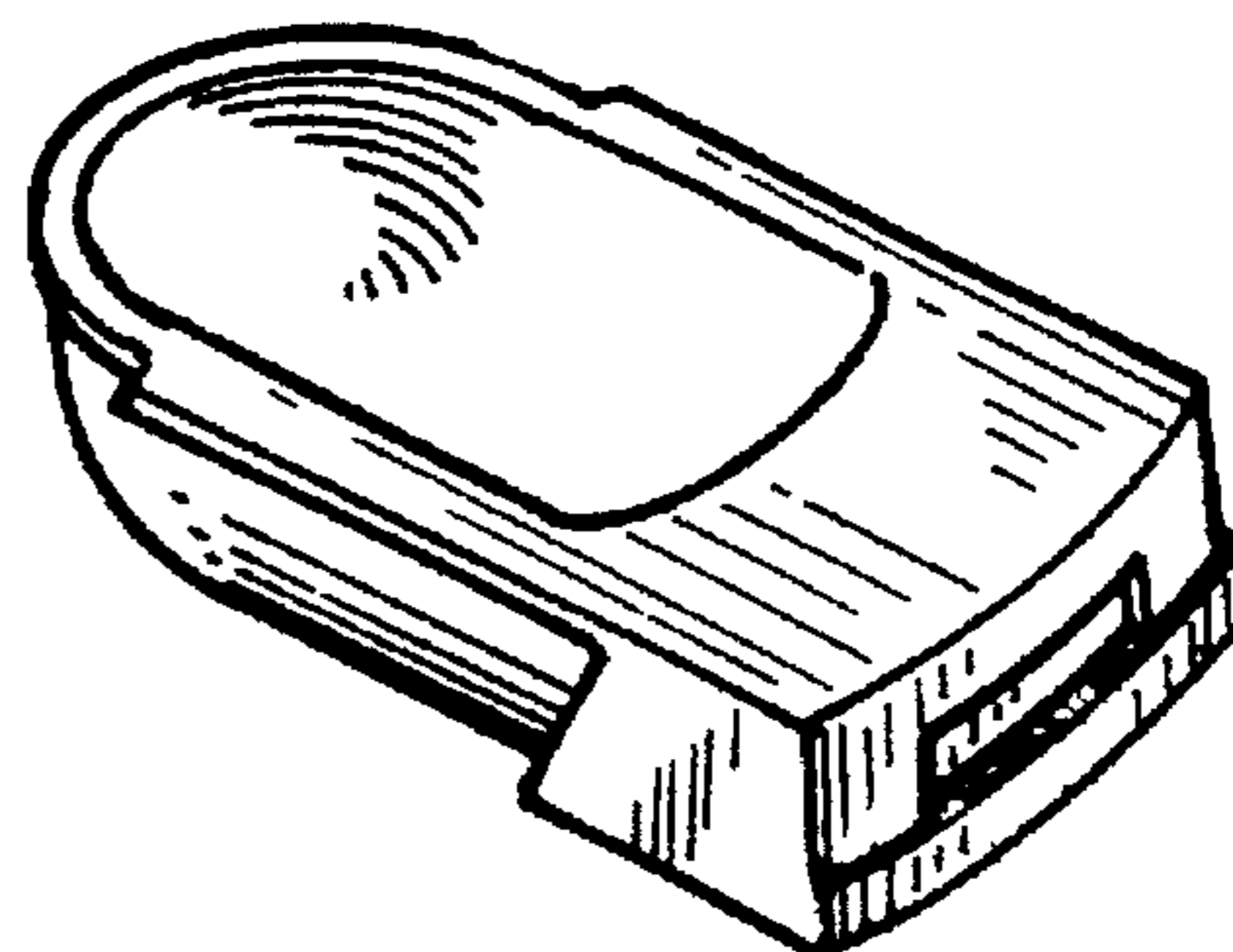
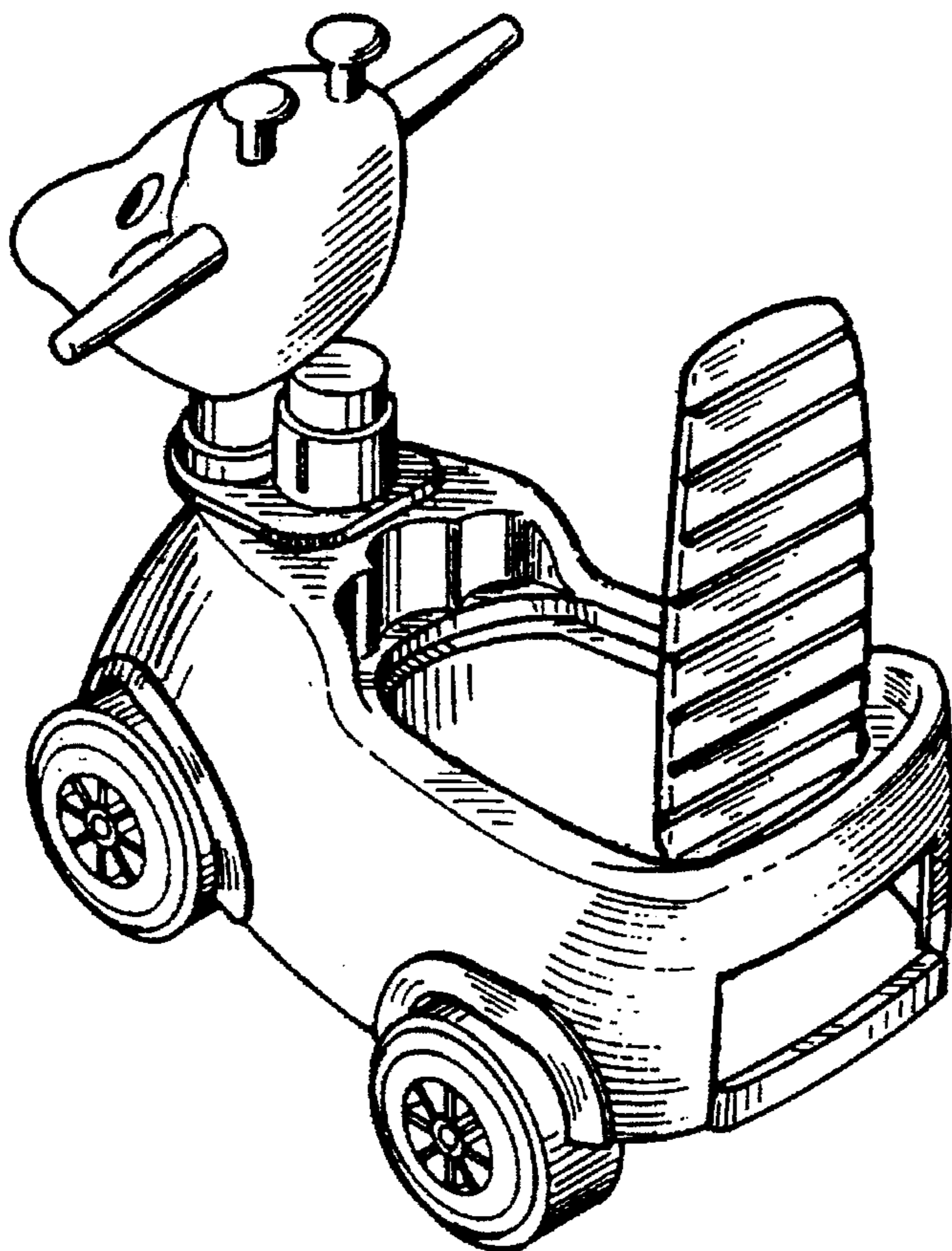

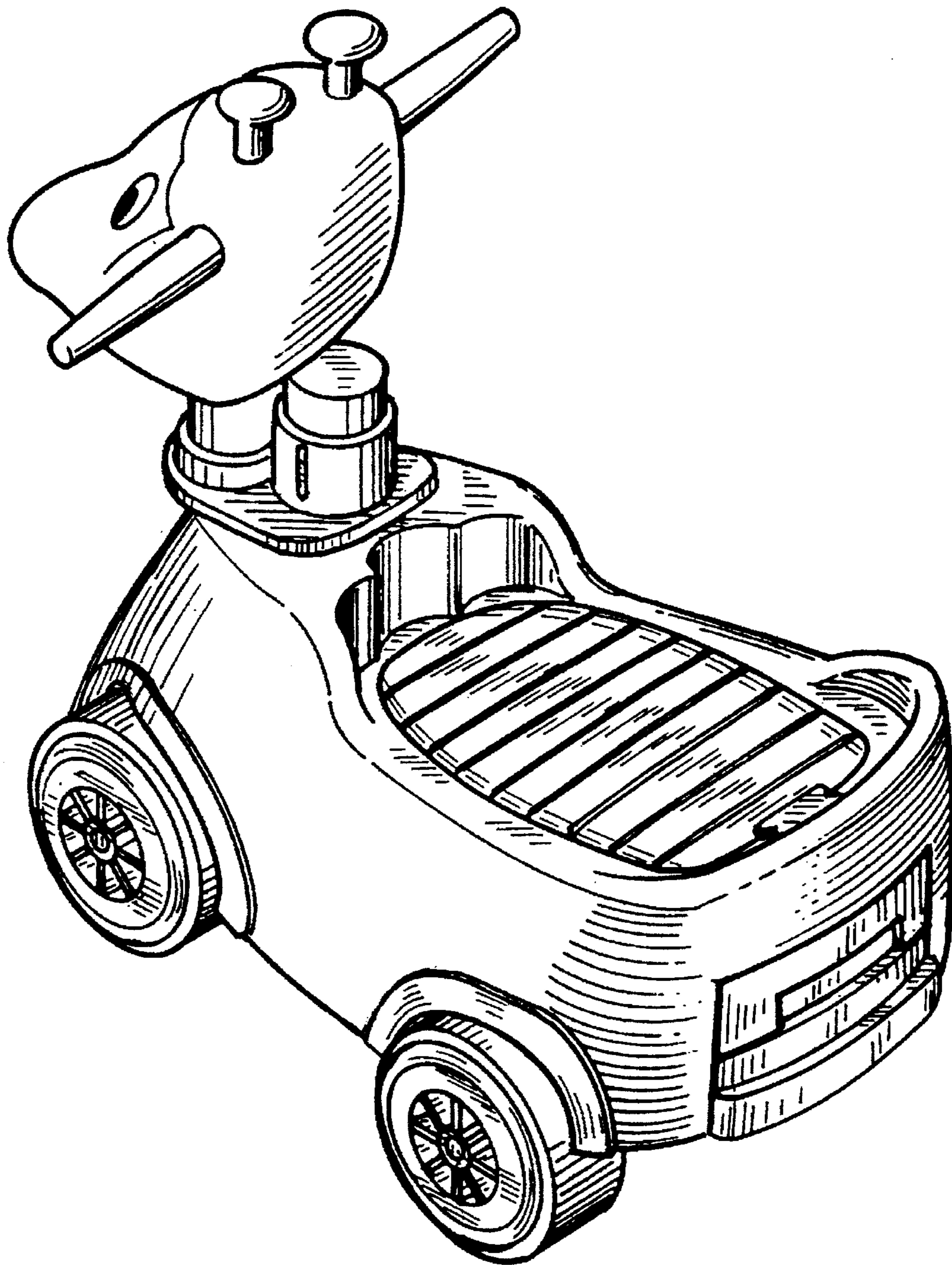

FIG. 1

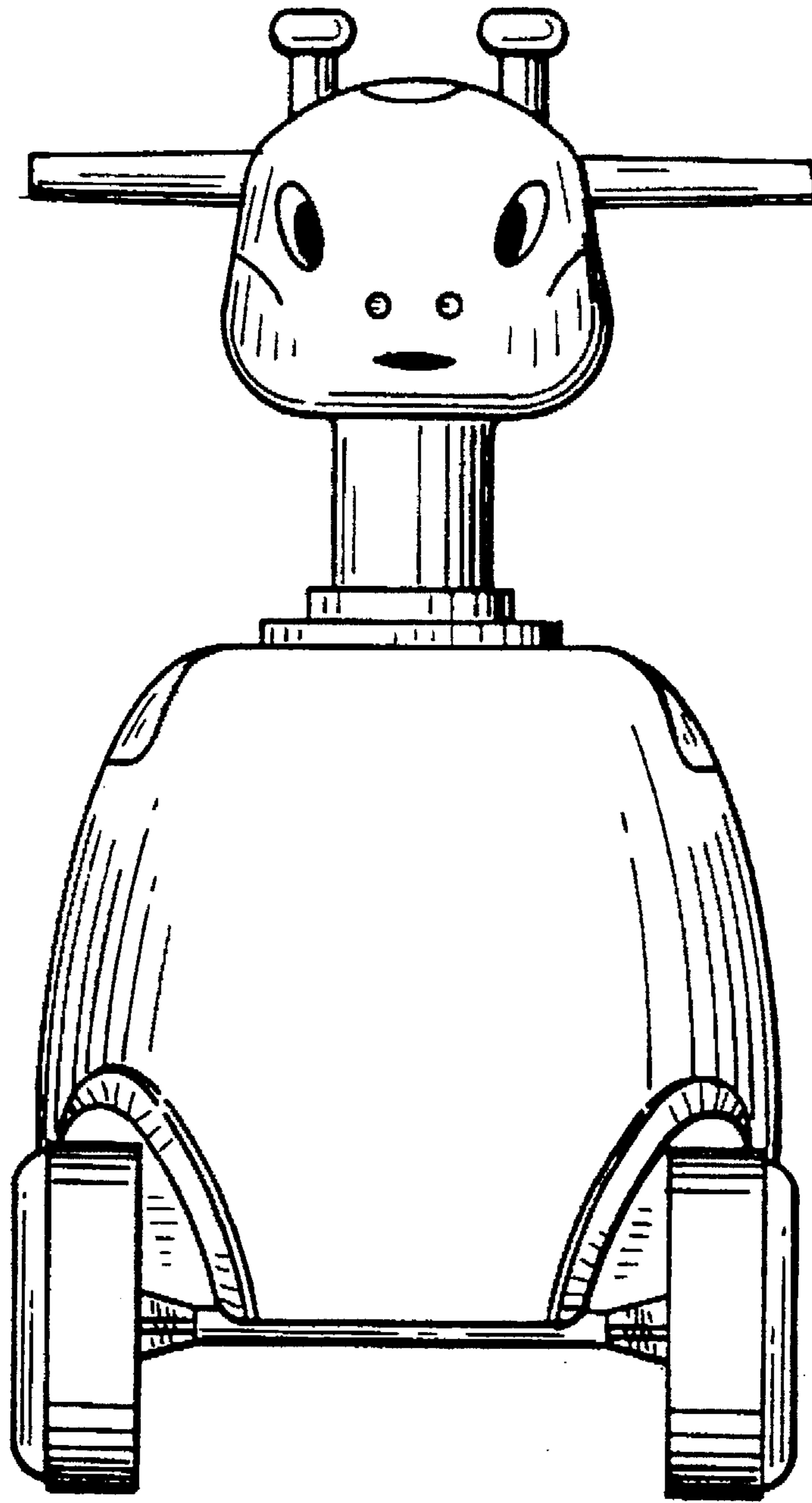
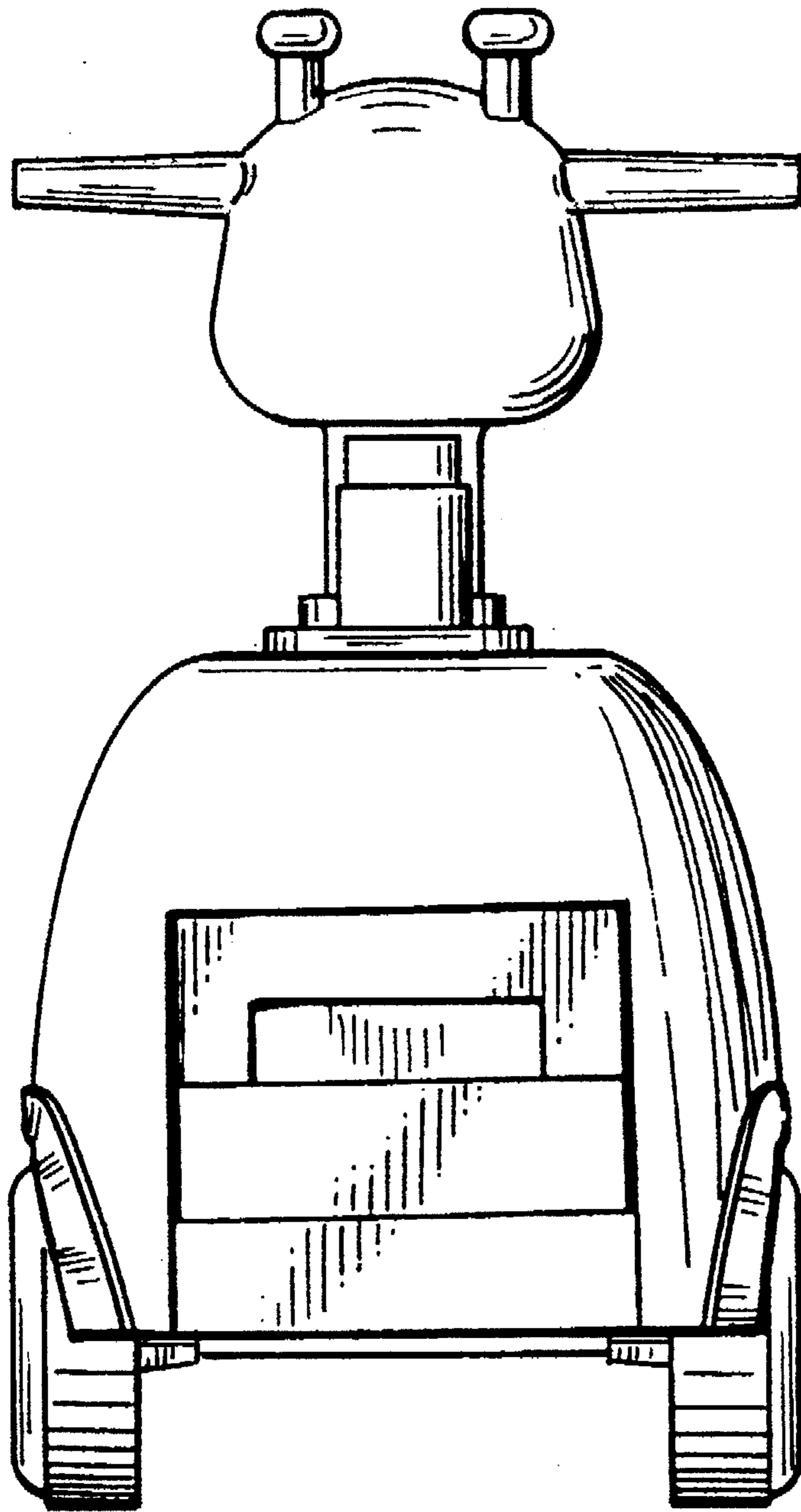

FIG. 2



*FIG. 3*

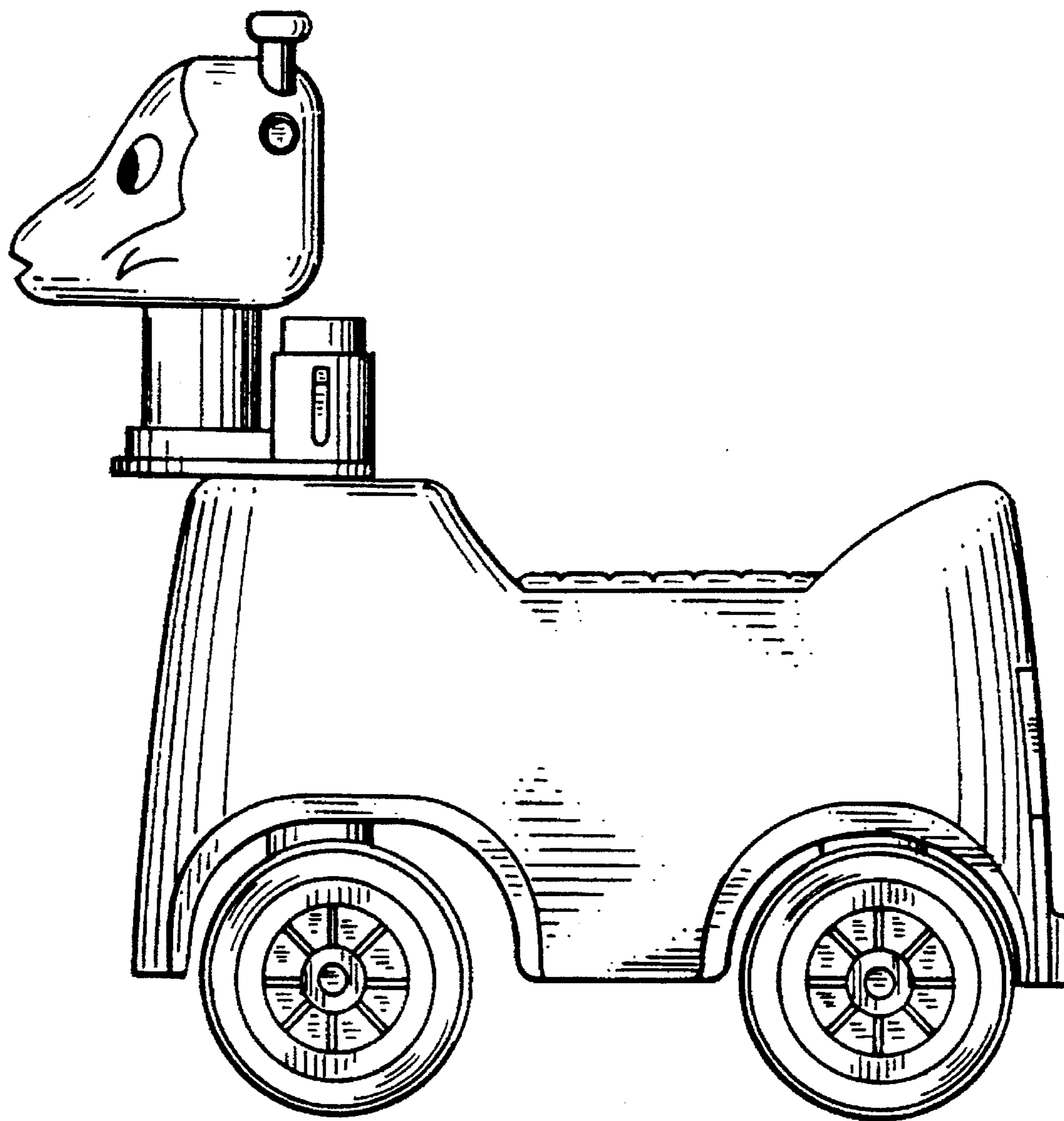
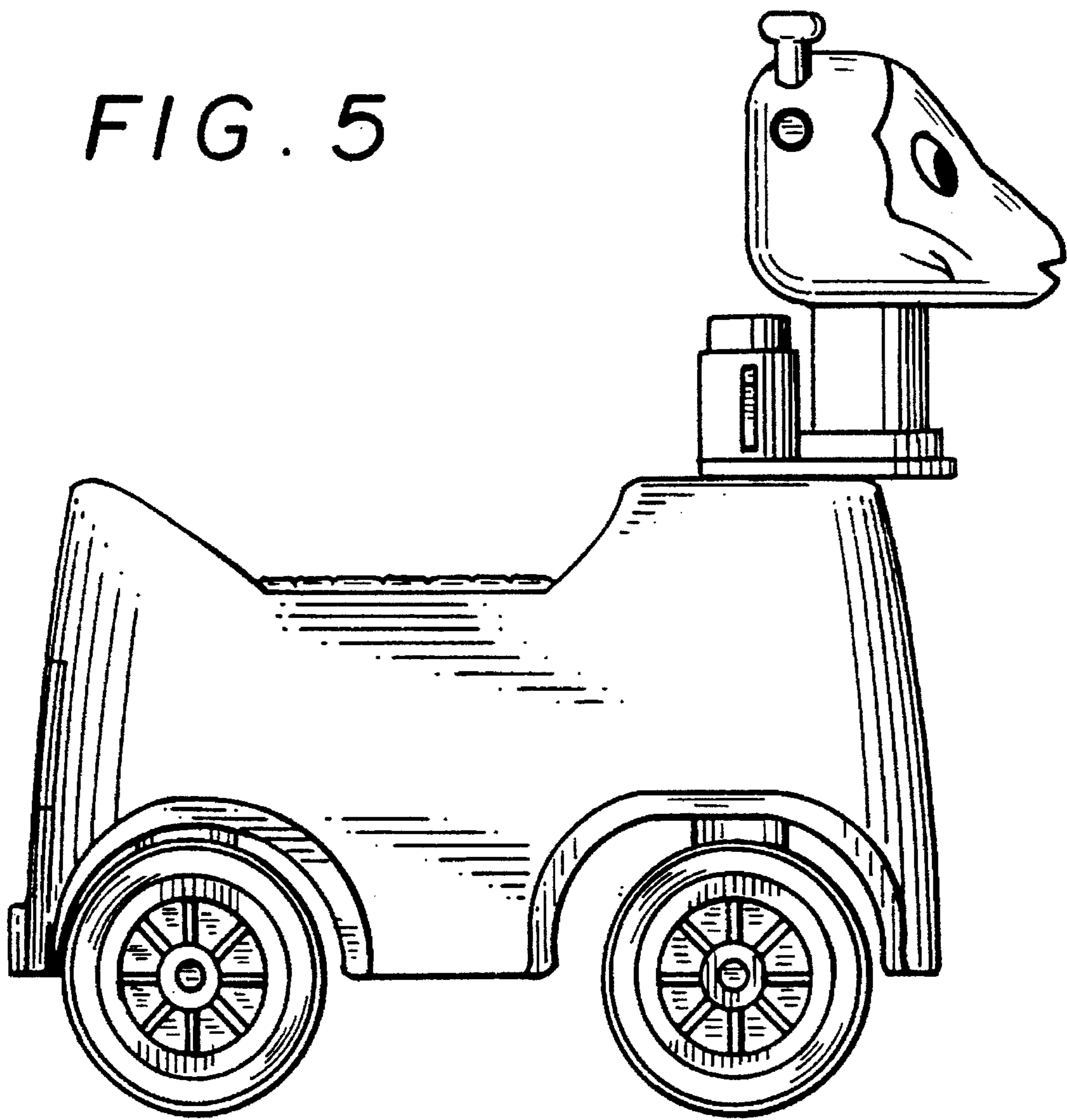

FIG. 4

FIG. 5



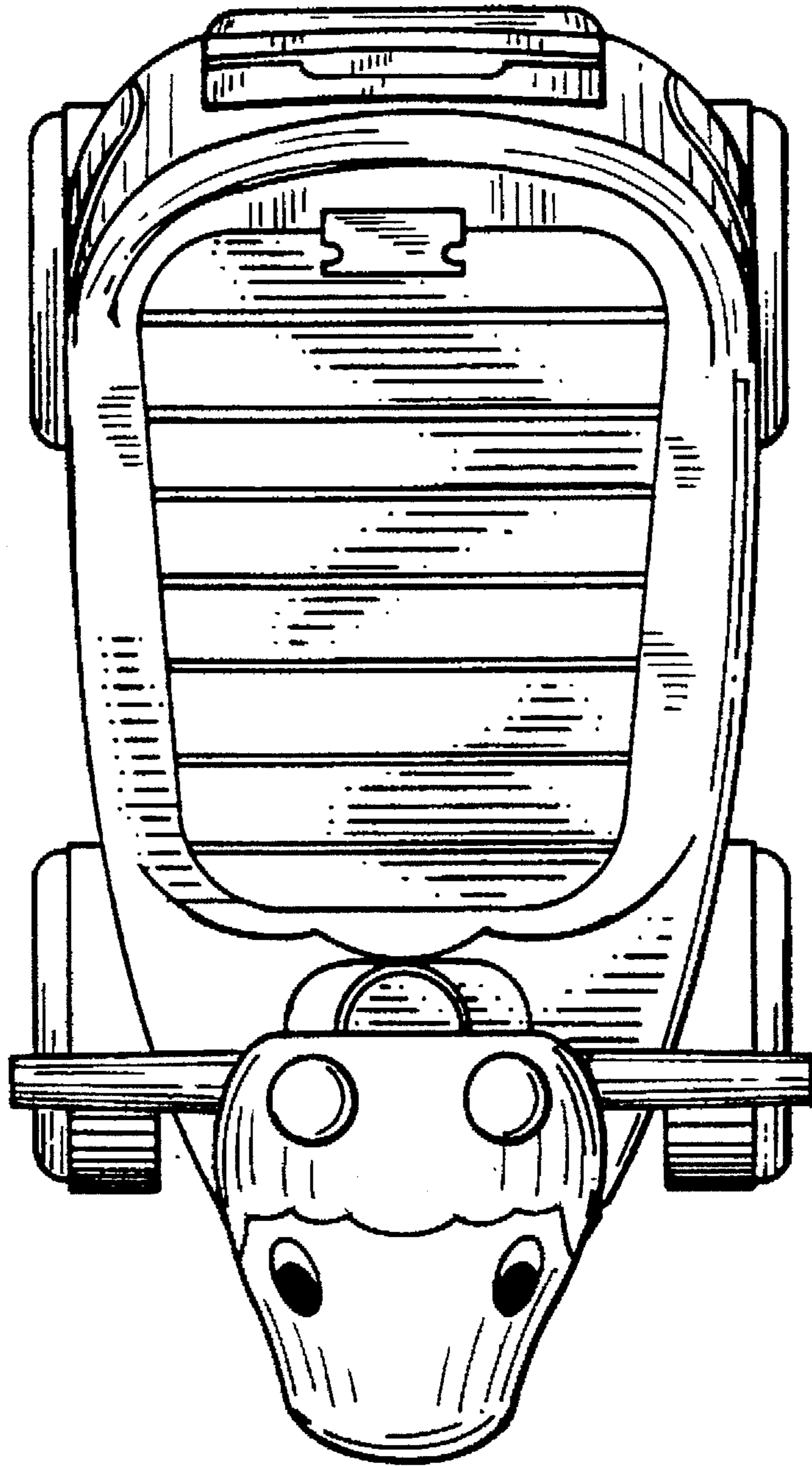

FIG. 6

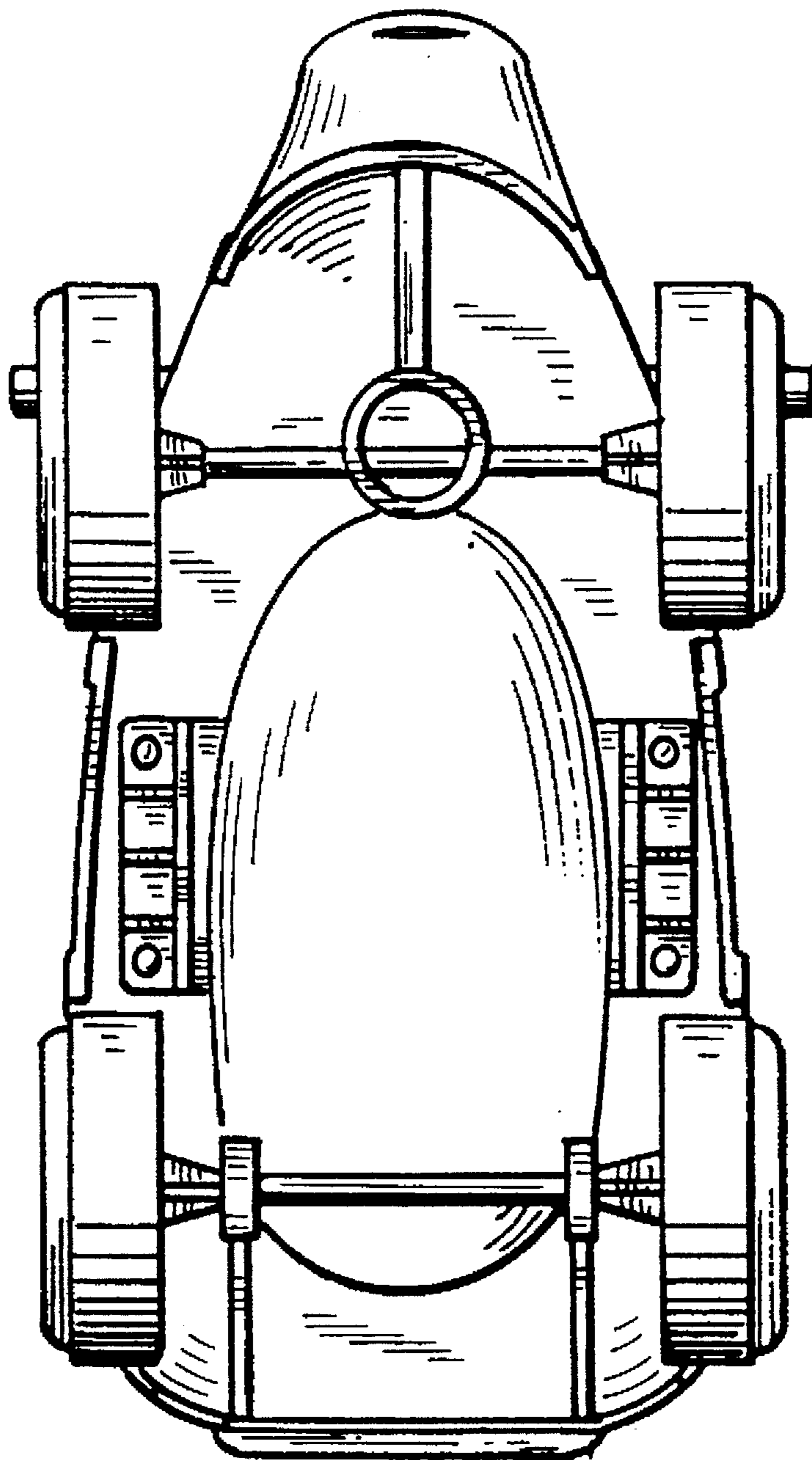

FIG. 7



