



US00D379366S

United States Patent [19] Hokazono

[11] Patent Number: Des. 379,366

[45] Date of Patent: **May 20, 1997

[54] CASH REGISTER

[75] Inventor: Manabu Hokazono, Nara-ken, Japan

[73] Assignee: Sharp Kabushiki Kaisha, Osaka, Japan

[**] Term: 14 Years

[21] Appl. No.: 43,821

[22] Filed: Sep. 13, 1995

[30] Foreign Application Priority Data

Mar. 13, 1995 [JP] Japan 7-6897

[51] LOC (6) Cl. 18-01

[52] U.S. Cl. D18/4; D14/105

[58] Field of Search D18/1, 2, 4, 6,
D18/7, 11, 12; D14/100, 105, 106, 115;
235/1 D, 1 E, 2, 4, 7 R, 10, 375, 380, 419,
145; 364/404, 405

[56] References Cited

U.S. PATENT DOCUMENTS

D. 330,906 11/1992 Kawaishi et al. D18/4

D. 333,147 2/1993 Miyake et al. D18/4
D. 353,613 12/1994 Miyake et al. D18/4
D. 354,977 1/1995 Miyake et al. D18/4
D. 361,757 8/1995 Mizusugi et al. D14/105
D. 362,427 9/1995 Mizusugi et al. D14/105

Primary Examiner—James M. Gandy
Assistant Examiner—Caron D. Veynar
Attorney, Agent, or Firm—Nixon & Vanderhye

[57] CLAIM

The ornamental design for a cash register, as shown and described.

DESCRIPTION

FIG. 1 is a top, left side and front perspective view of a cash register according to my design;
FIG. 2 is a top plan view thereof;
FIG. 3 is a front elevational view thereof;
FIG. 4 is a right side elevational view thereof;
FIG. 5 is a rear elevational view thereof;
FIG. 6 is a left side elevational view thereof; and,
FIG. 7 is a bottom plan view thereof.

1 Claim, 7 Drawing Sheets

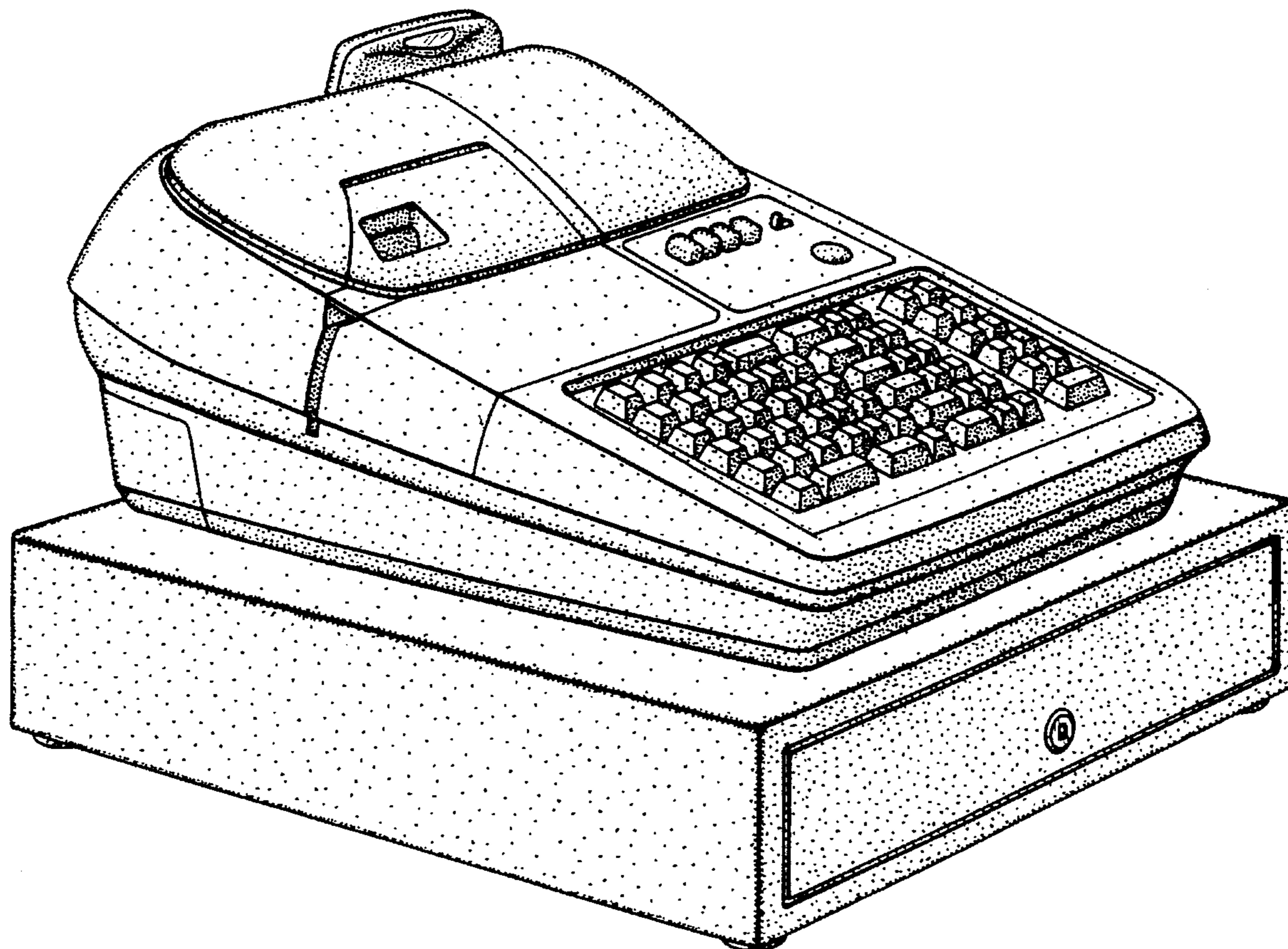

FIG. 1

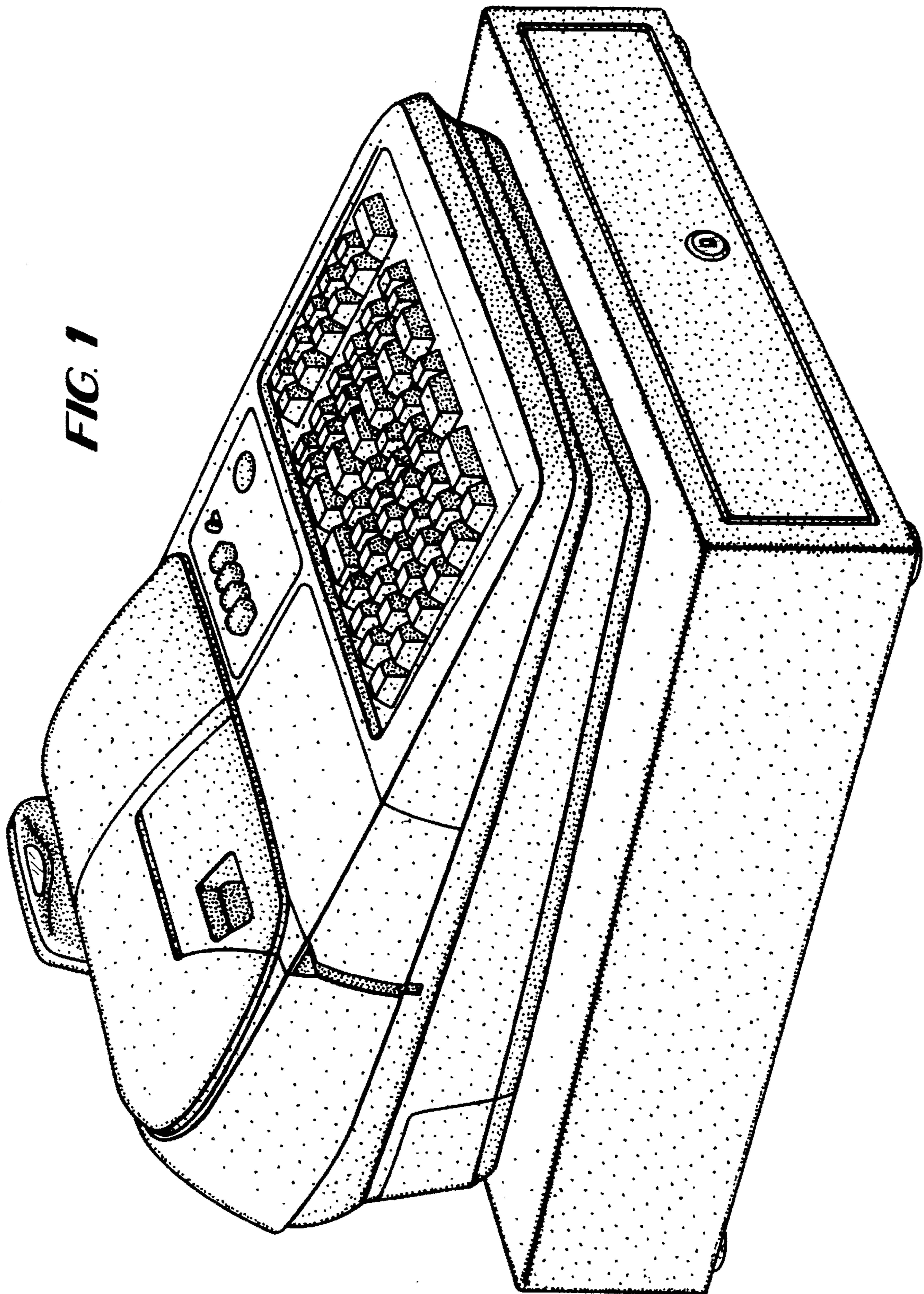

FIG. 2

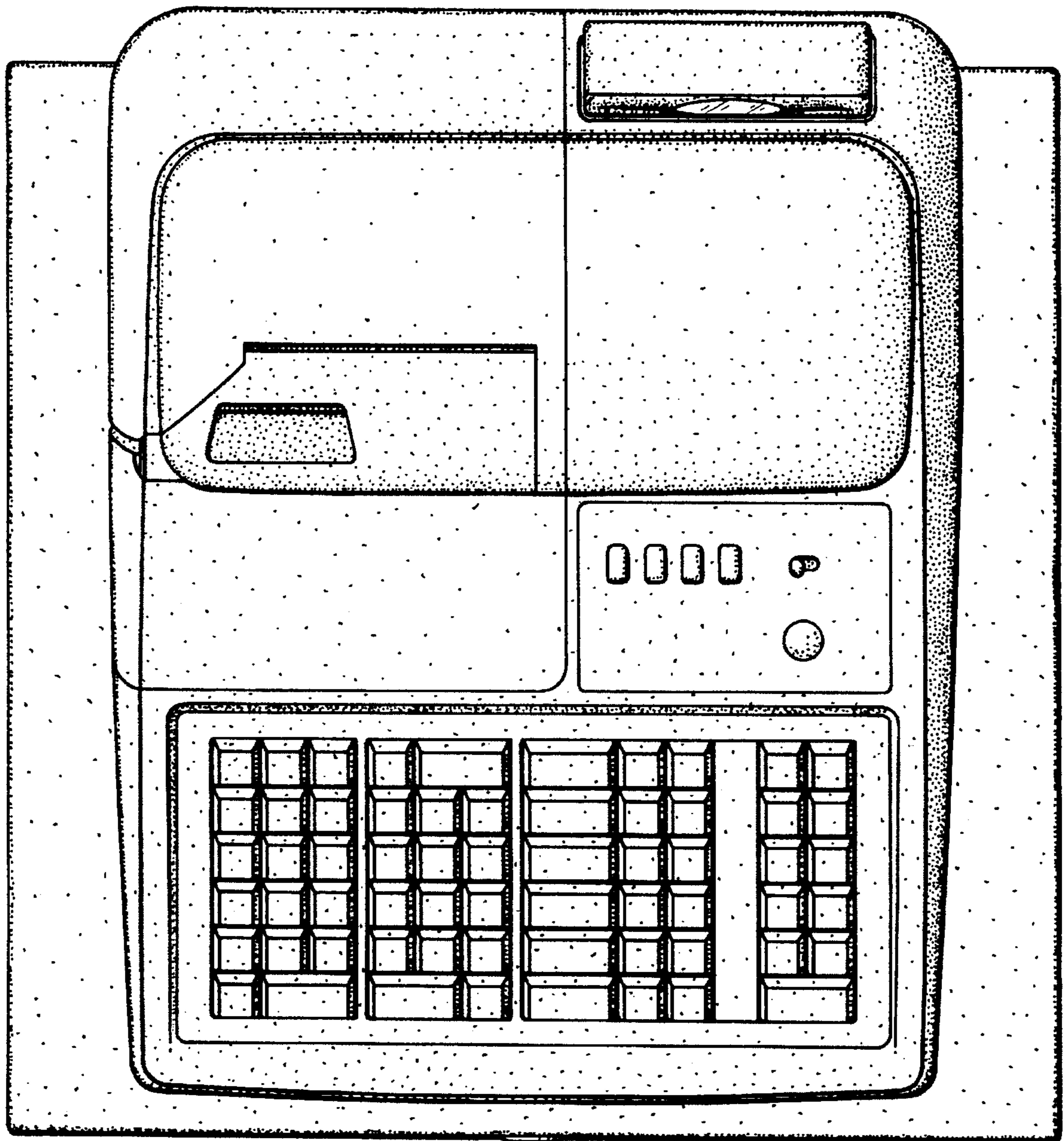
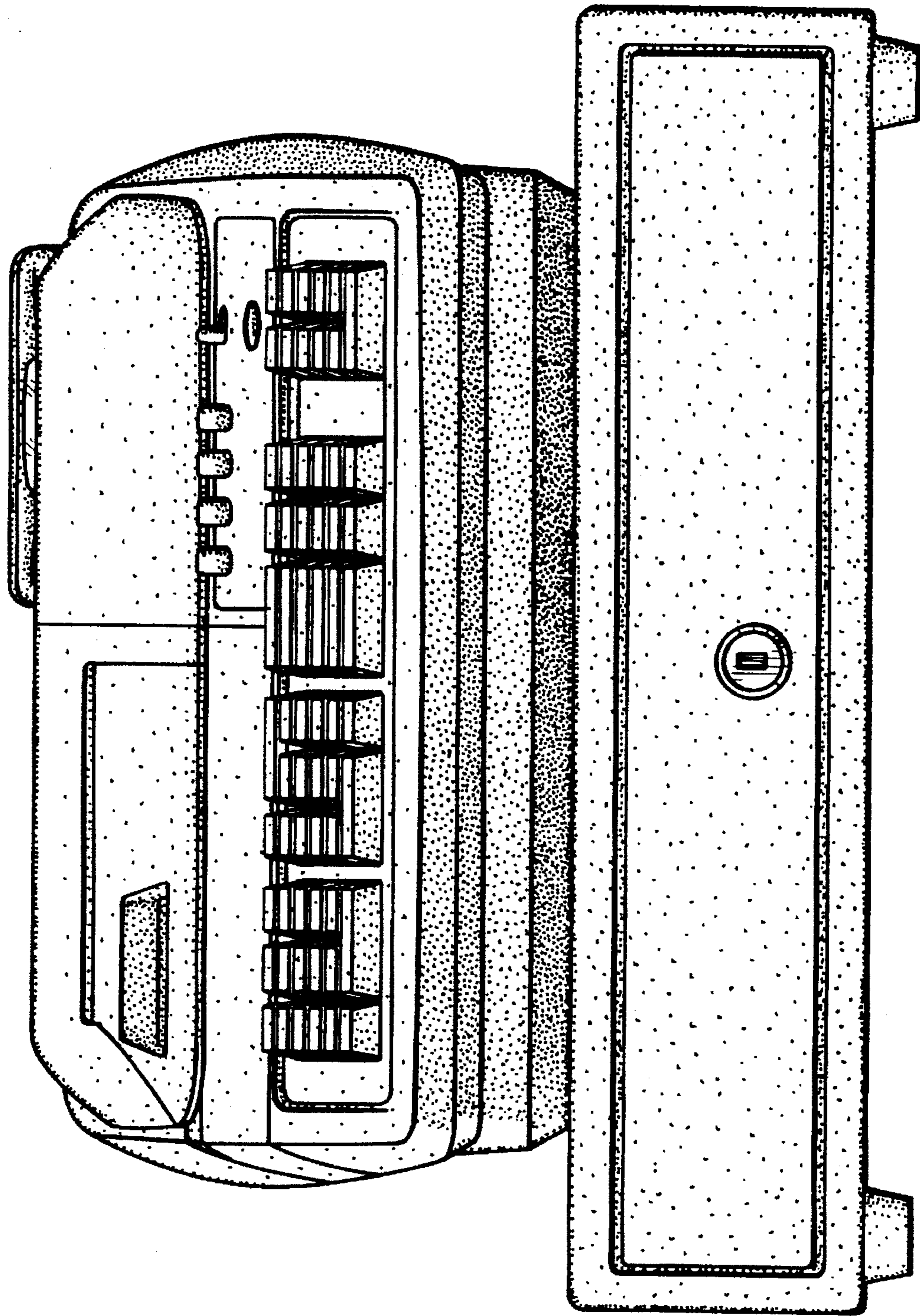

FIG. 3



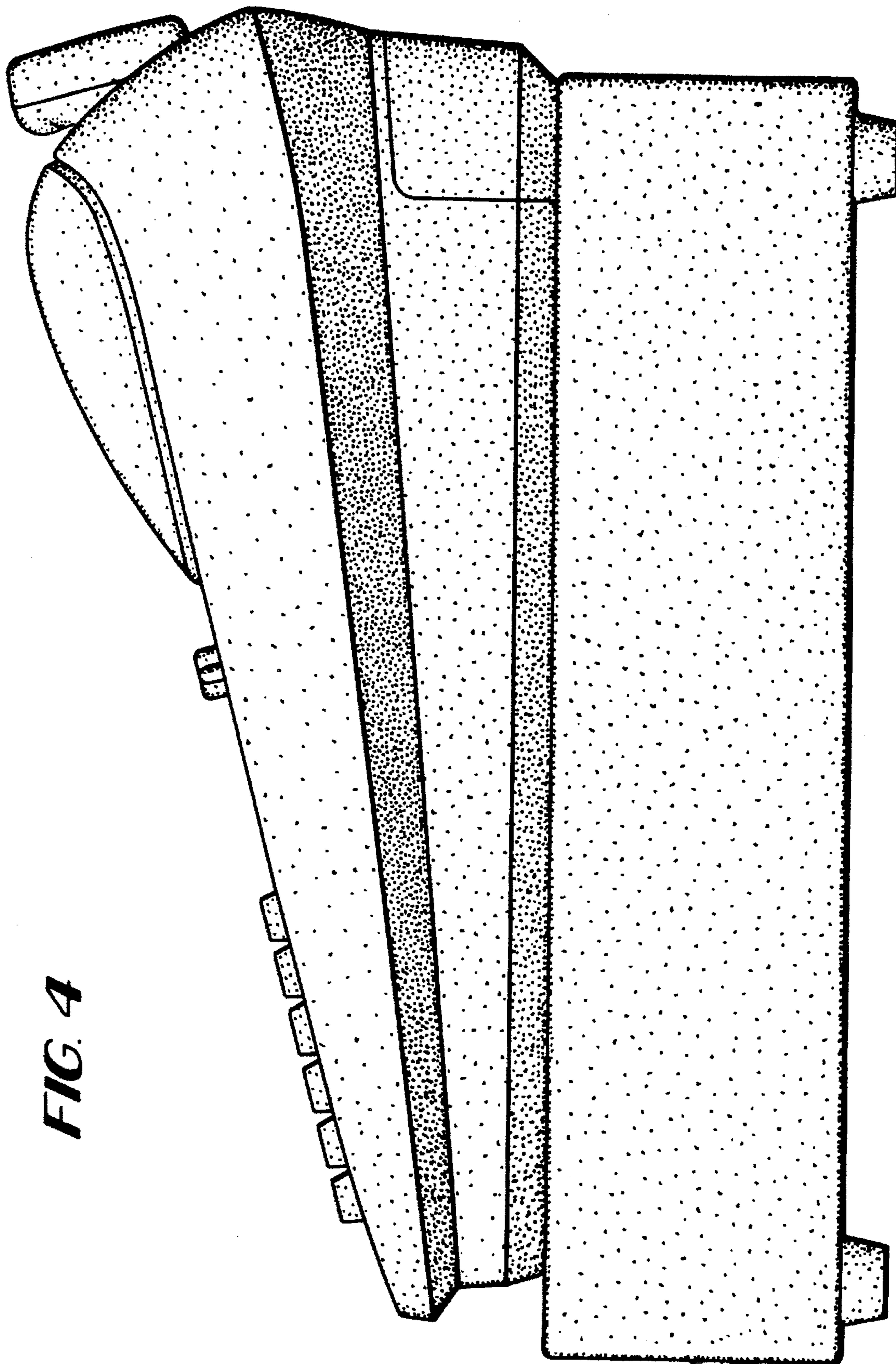

FIG. 4

FIG. 5

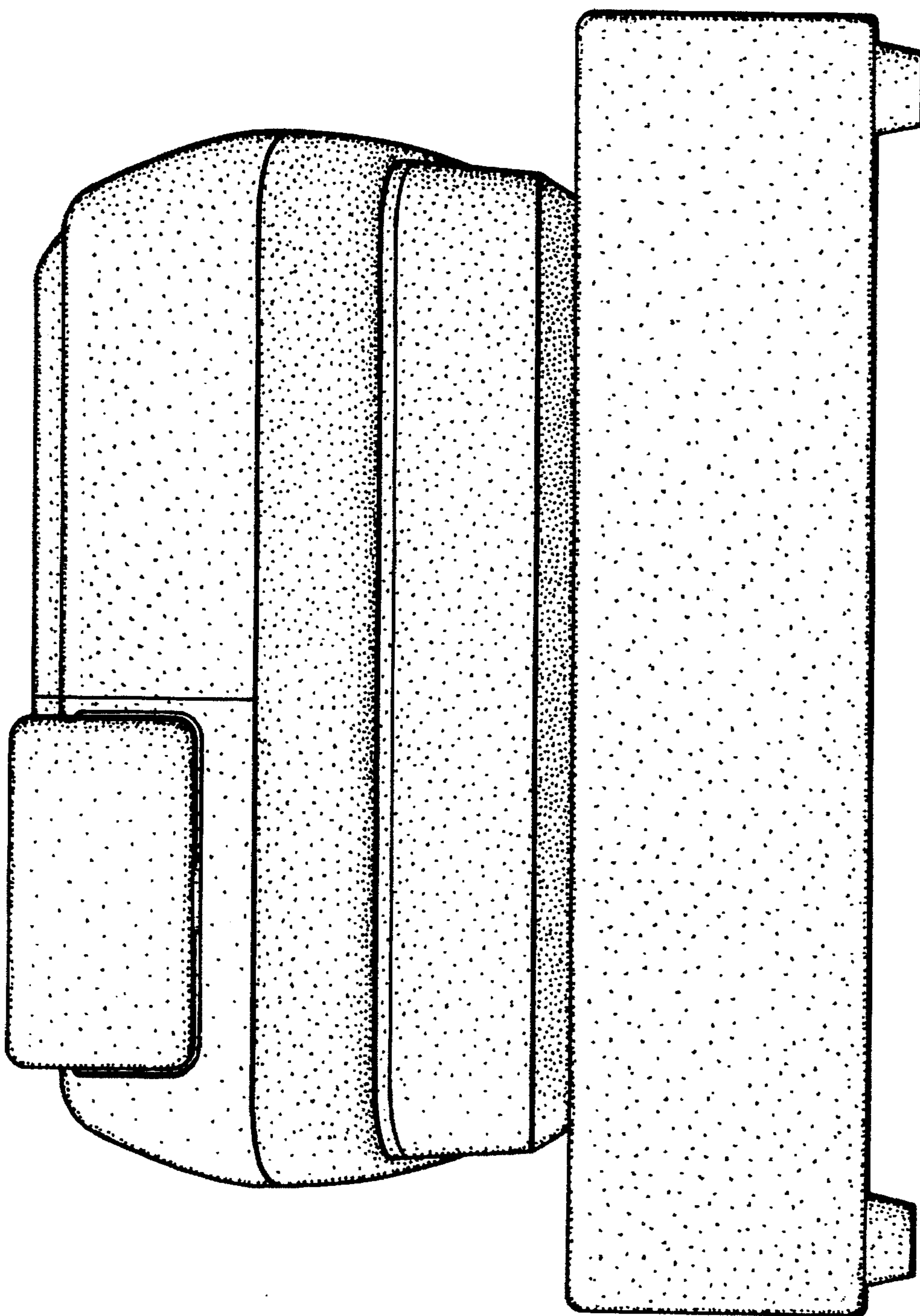

FIG. 6

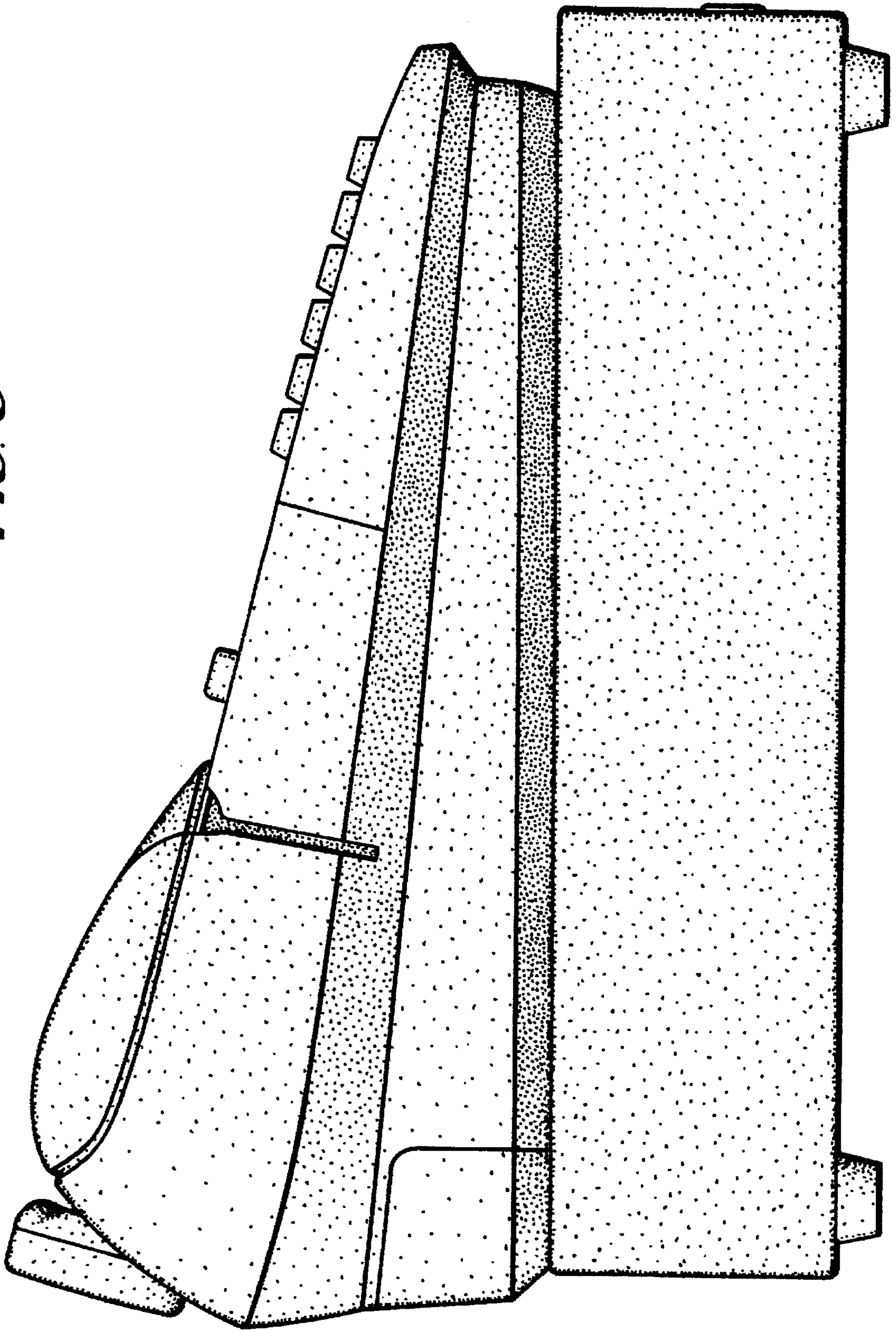

FIG. 7

