



US00D379360S

United States Patent [19]

Satran et al.

[11] Patent Number: **Des. 379,360**

[45] Date of Patent: ****May 20, 1997**

[54] **CUTTING INSERT**

[75] Inventors: **Amir Satran, Kfar Vradim; Rafael Margulis, Karmiel, both of Israel**

[73] Assignee: **Iscar Ltd., Migdal Tefen, Israel**

[**] Term: **14 Years**

[21] Appl. No.: **48,892**

[22] Filed: **Jan. 16, 1996**

[30] **Foreign Application Priority Data**

Jul. 19, 1995 [IL] Israel 24770

[51] **LOC (6) Cl.** **15-09**

[52] **U.S. Cl.** **D15/139**

[58] **Field of Search** **D15/139; 407/112-119**

[56] **References Cited**

U.S. PATENT DOCUMENTS

D. 369,362	4/1996	Pantzer et al.	D15/139	X
4,632,607	12/1986	Pantzar	407/113	
5,004,380	4/1991	Hessman et al.	407/114	

Primary Examiner—Antoine Duval Davis
Attorney, Agent, or Firm—Pennie & Edmonds

[57] **CLAIM**

The ornamental design for a cutting insert, as shown and described.

DESCRIPTION

FIG. 1 is a perspective view of the cutting insert incorporating our new design;
 FIG. 2 is a top view of the cutting insert incorporating our new design;
 FIG. 3 is a first elevation view from one side of the cutting insert incorporating our new design;
 FIG. 4 is a second side elevation view from a second and opposite side of the cutting insert;
 FIG. 5 is a first end elevation view from one end of the cutting insert incorporating our new design;
 FIG. 6 is a second end elevation view from a second and opposite end of the cutting insert incorporating our new design; and,
 FIG. 7 is a bottom view of the cutting insert incorporating our new design.

1 Claim, 5 Drawing Sheets

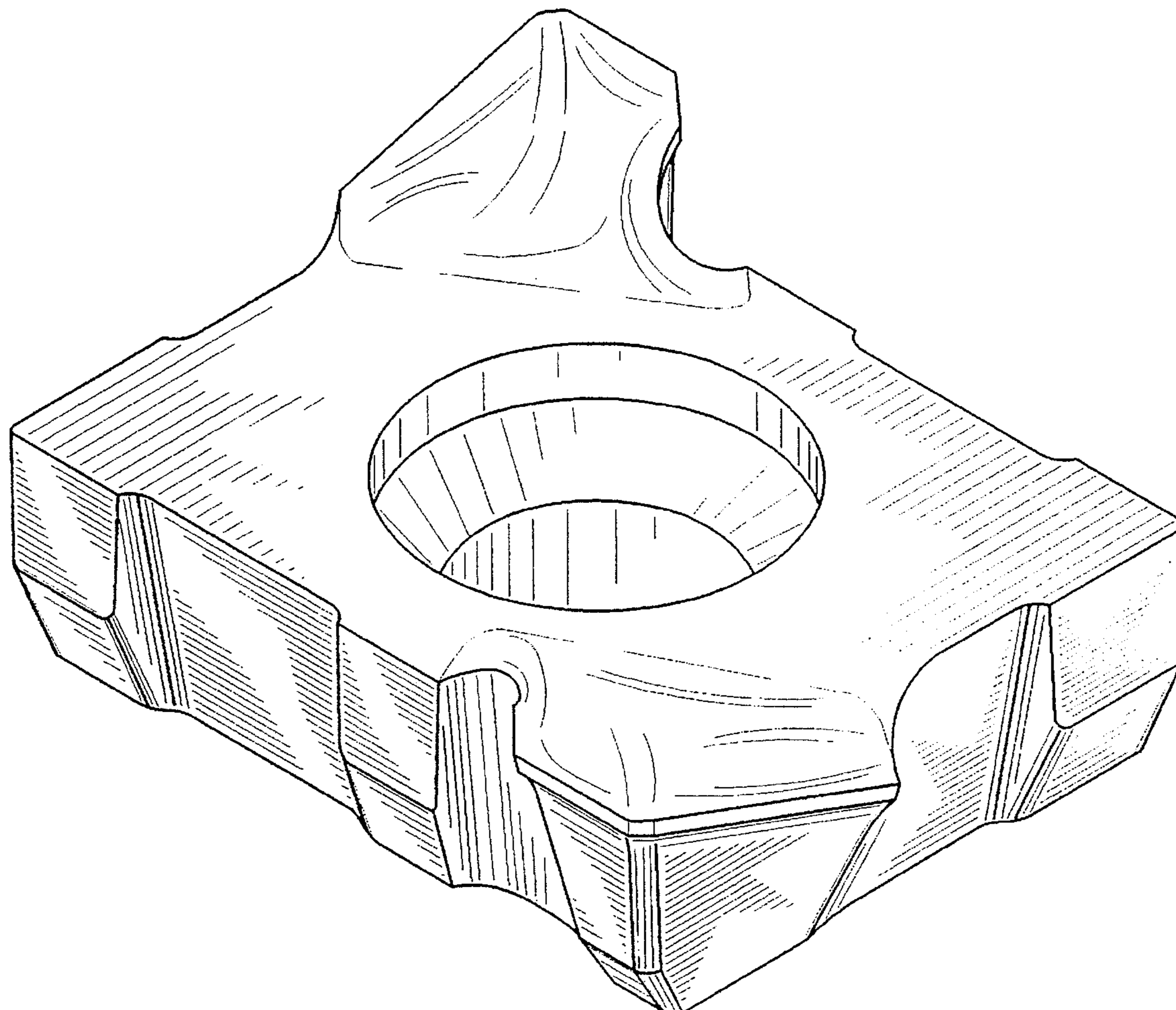
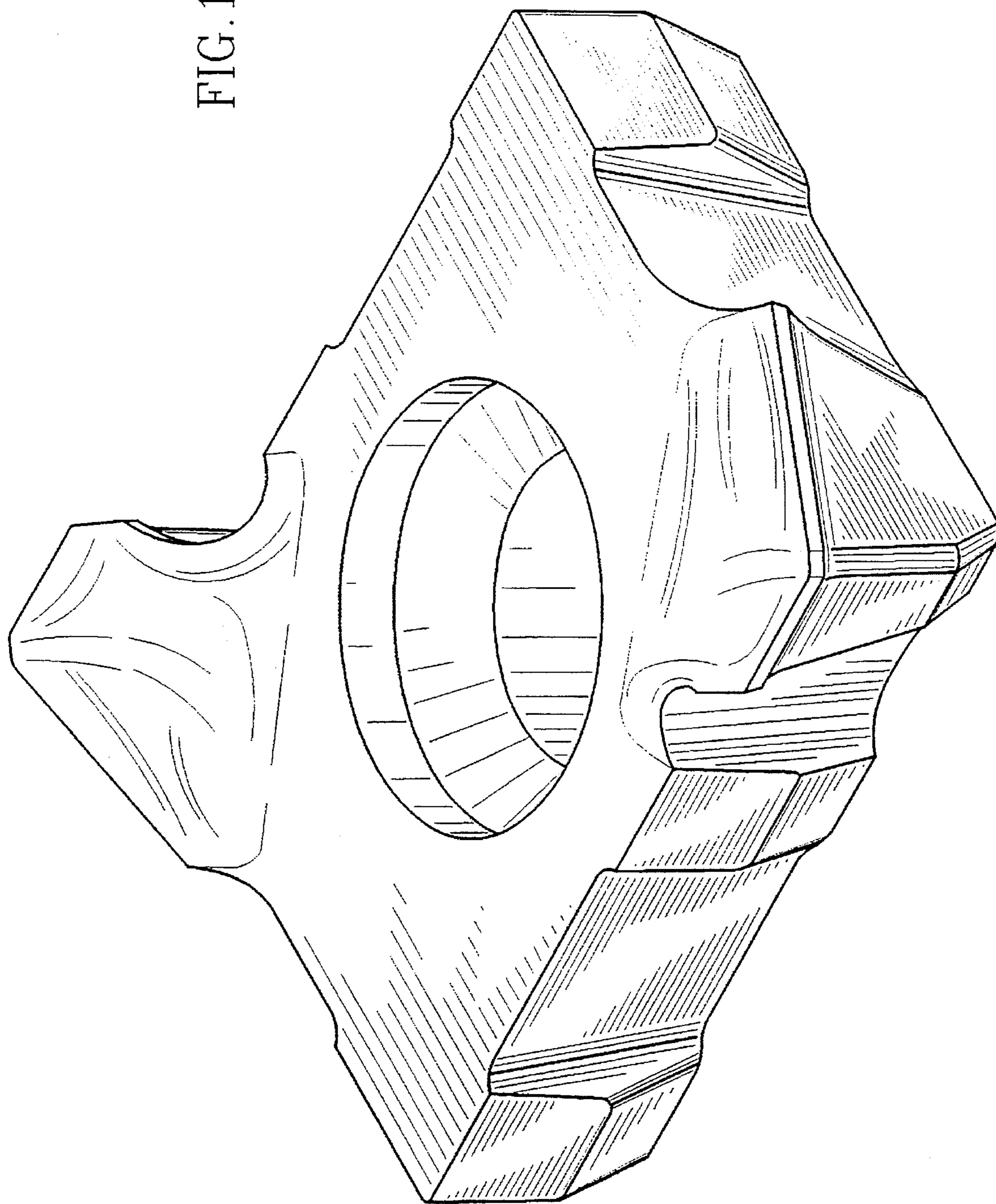

FIG. 1



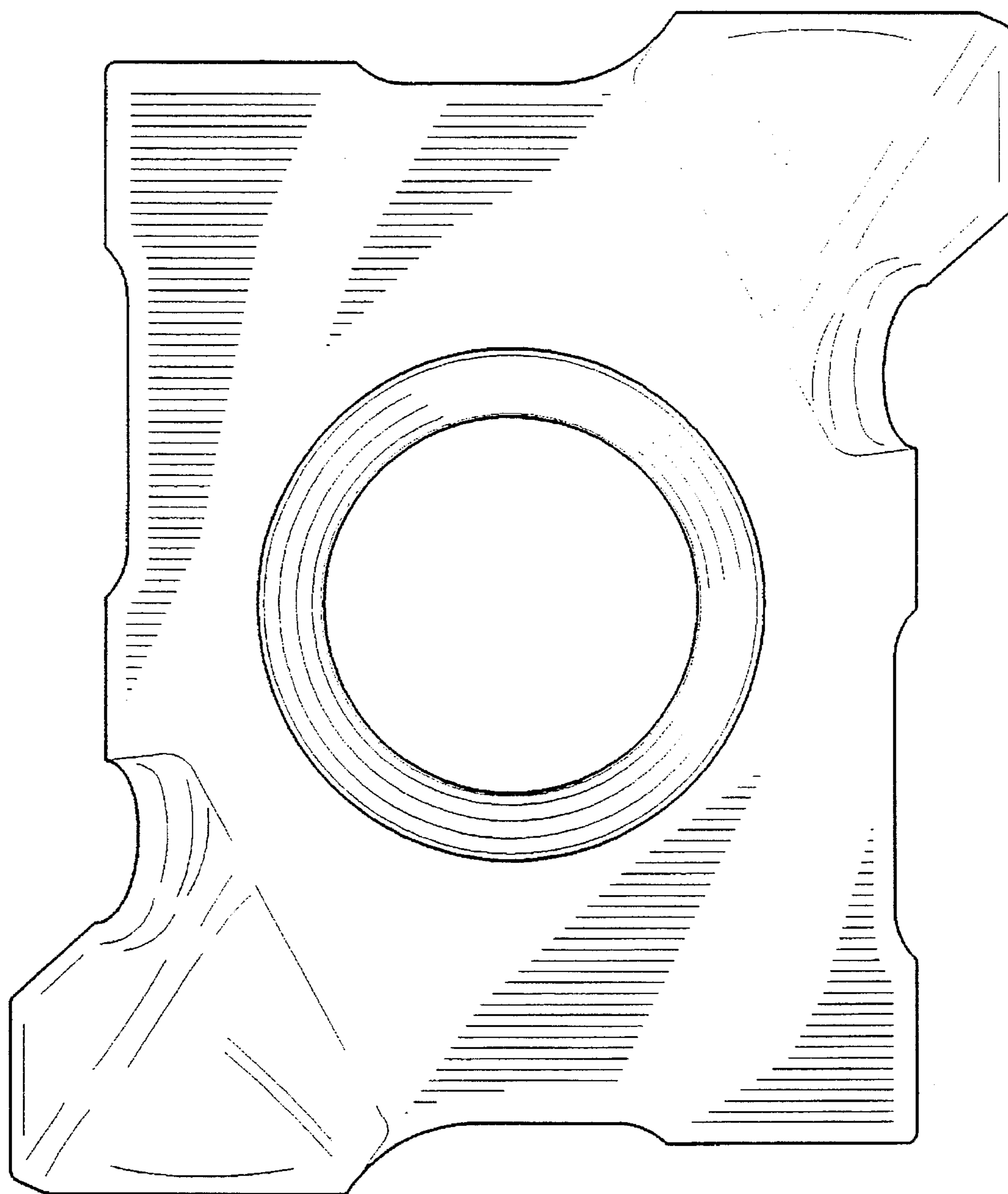

FIG.2

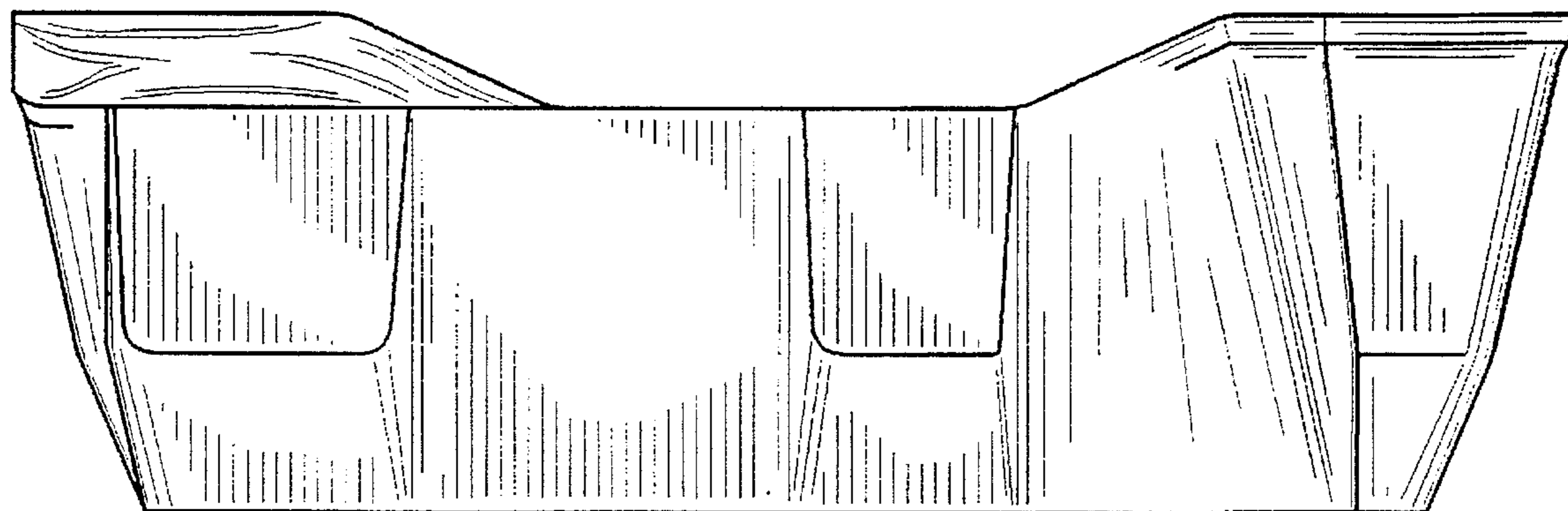

FIG. 3

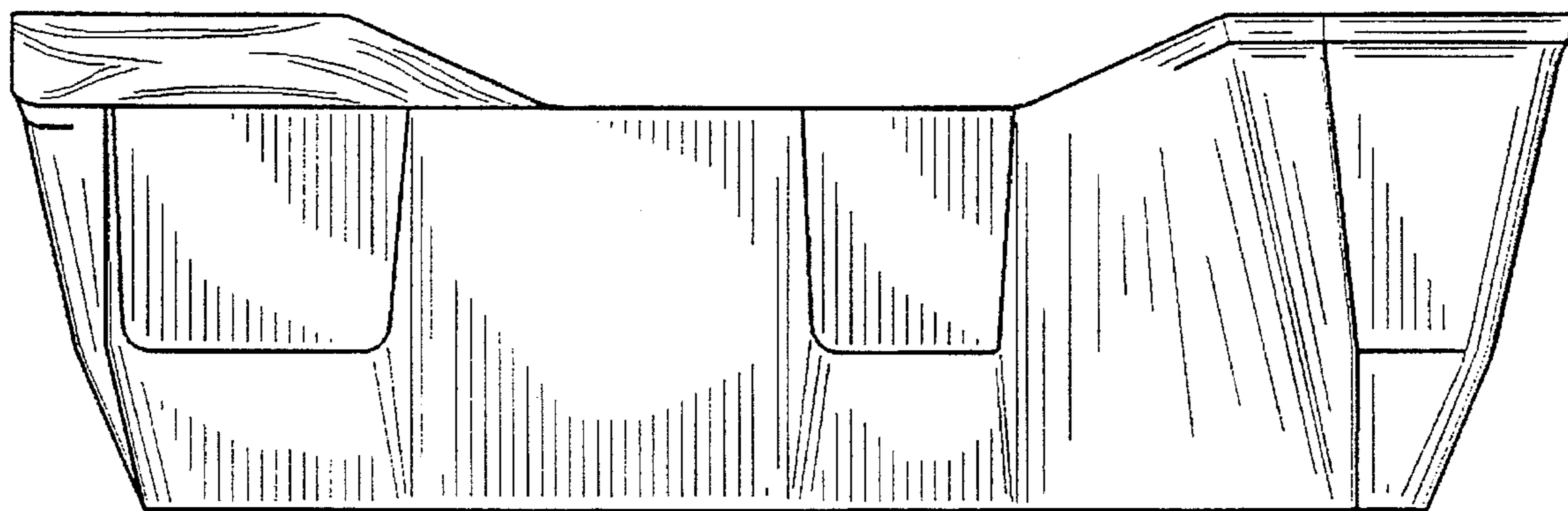

FIG. 4

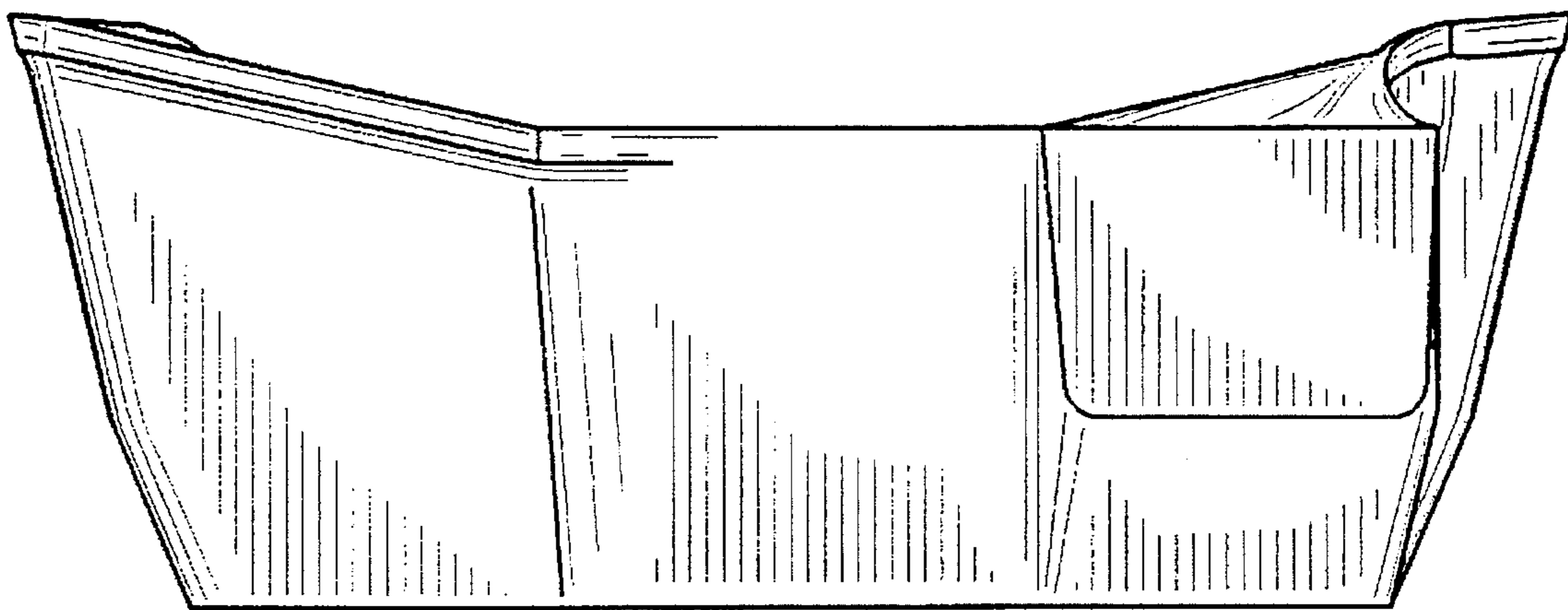

FIG. 5

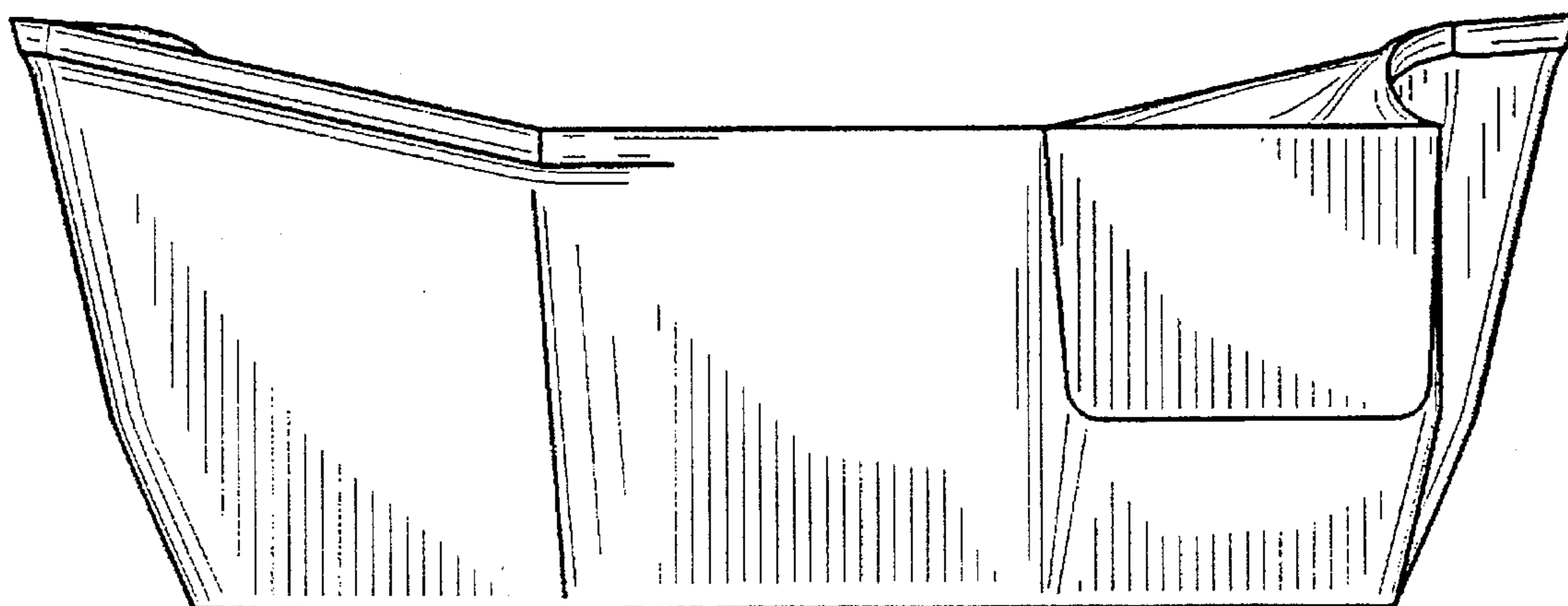

FIG. 6

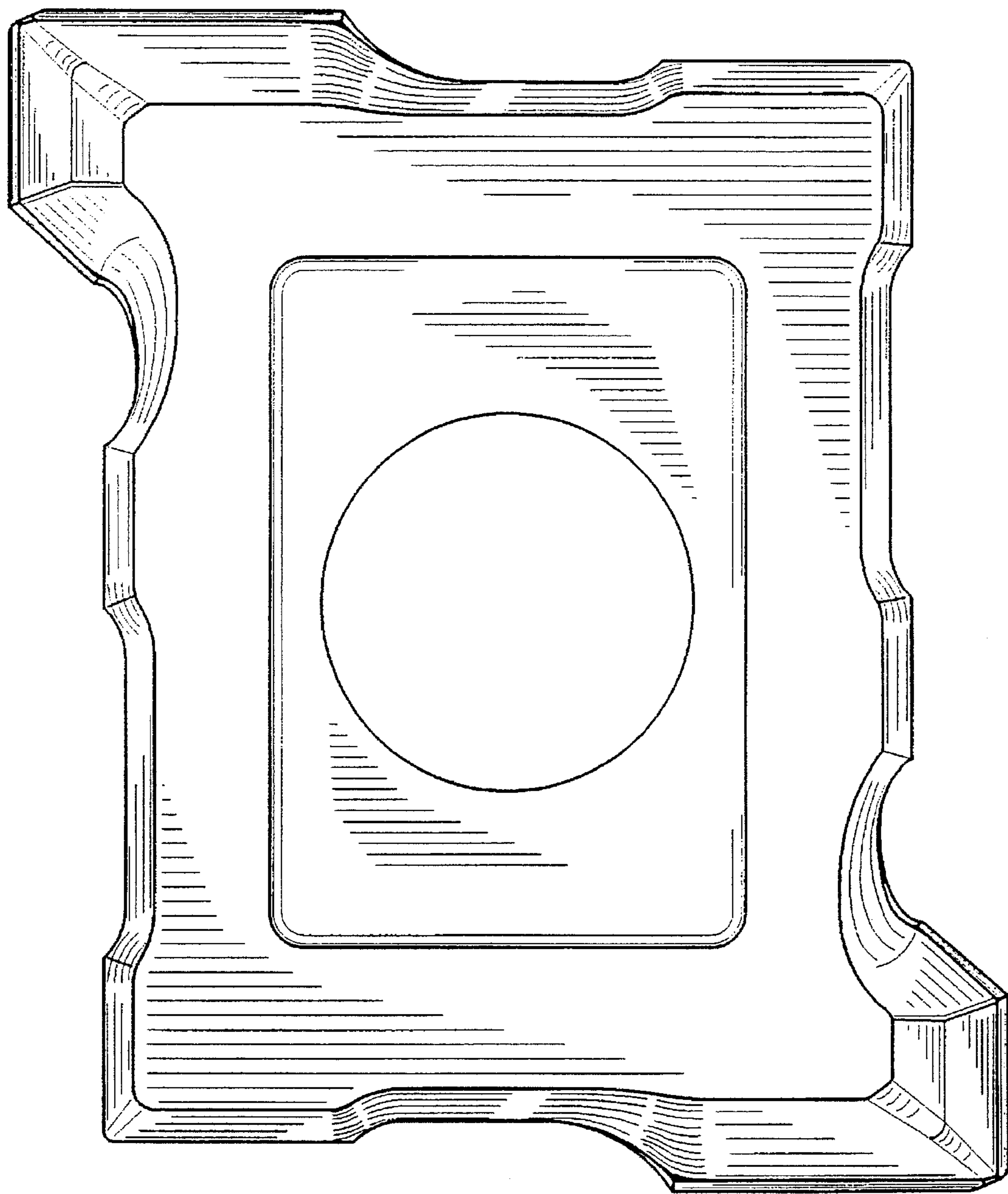

FIG. 7