



US00D379247S

United States Patent [19]
Stangland

[11] **Patent Number: Des. 379,247**
[45] **Date of Patent: **May 13, 1997**

[54] **COMBINATION CLIP AND MINIATURE LIGHT HOLDER FOR CHRISTMAS TREE LIGHT COVERS**

[75] **Inventor: Chris K. Stangland**, Lake Oswego, Oreg.

[73] **Assignee: Euro/Pacific Corporation**, Lake Oswego, Oreg.

[**] **Term: 14 Years**

[21] **Appl. No.: 47,019**

[22] **Filed: Sep. 27, 1995**

[51] **LOC (6) Cl. 26-99**

[52] **U.S. Cl. D26/138**

[58] **Field of Search** D26/138; D8/394-396, D8/354; 362/190-191, 396; 248/225.31, 229-231, 231.6, 231.8

[56] **References Cited**

U.S. PATENT DOCUMENTS

- D. 297,616 9/1988 Doty et al. D26/138 X
- D. 356,246 3/1995 Adams D8/395

- D. 365,170 12/1995 Ng et al. D26/138
- D. 367,603 3/1996 Ng et al. D8/373

Primary Examiner—Holly H. Baynham
Attorney, Agent, or Firm—Chernoff, Vilhauer, McClung & Stenzel

[57] **CLAIM**

The ornamental design for a combination clip and miniature light holder for Christmas tree light covers, as shown.

DESCRIPTION

FIG. 1 is a front elevational view of a combination clip and miniature light holder for Christmas tree light covers, showing my new design;
 FIG. 2 is a first side elevational view thereof;
 FIG. 3 is an opposed side elevational view thereof with the broken line showing a portion of a Christmas tree light and a light cover for illustrative purposes only and forming no part of the claimed design;
 FIG. 4 is a rear elevational view thereof;
 FIG. 5 is a top plan view thereof; and,
 FIG. 6 is a bottom plan view thereof.

1 Claim, 1 Drawing Sheet

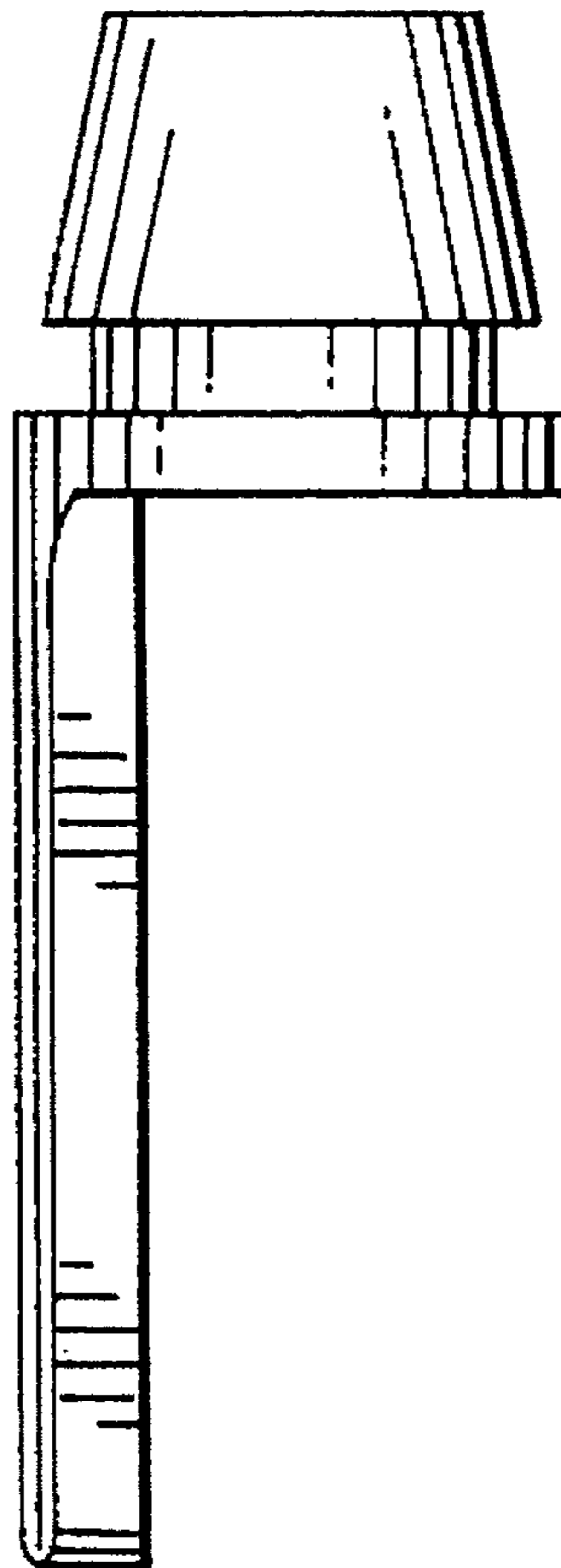
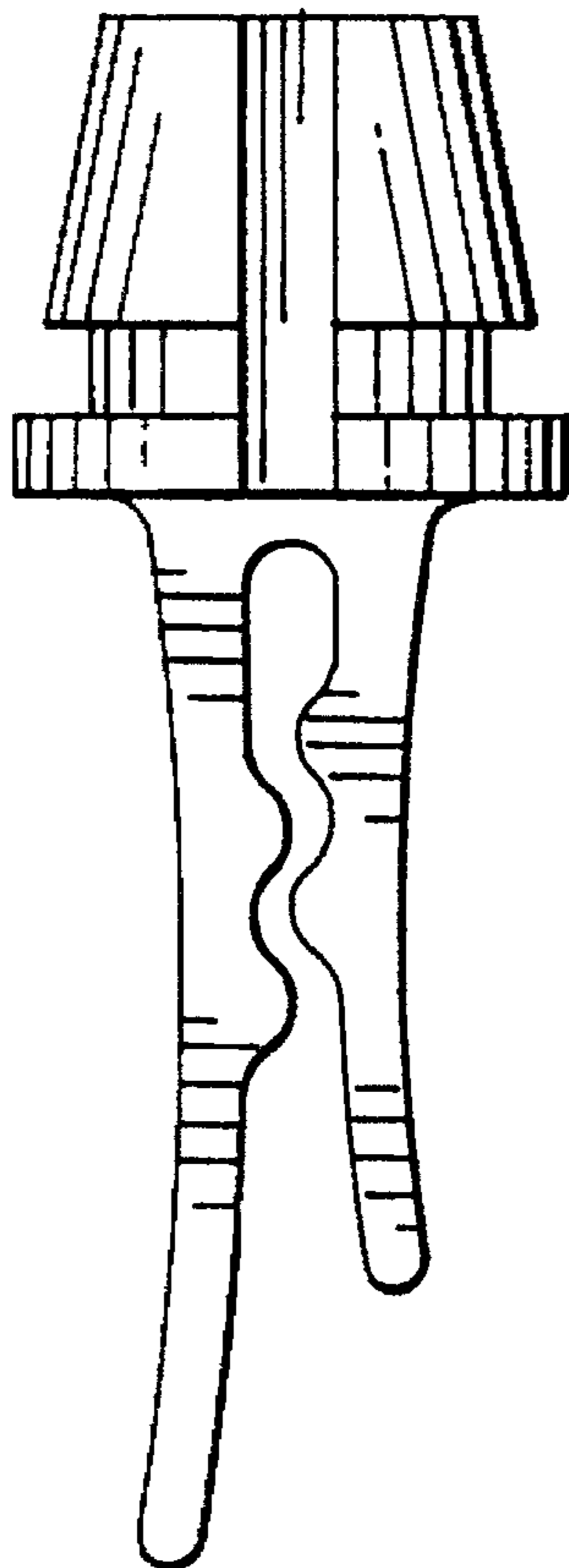

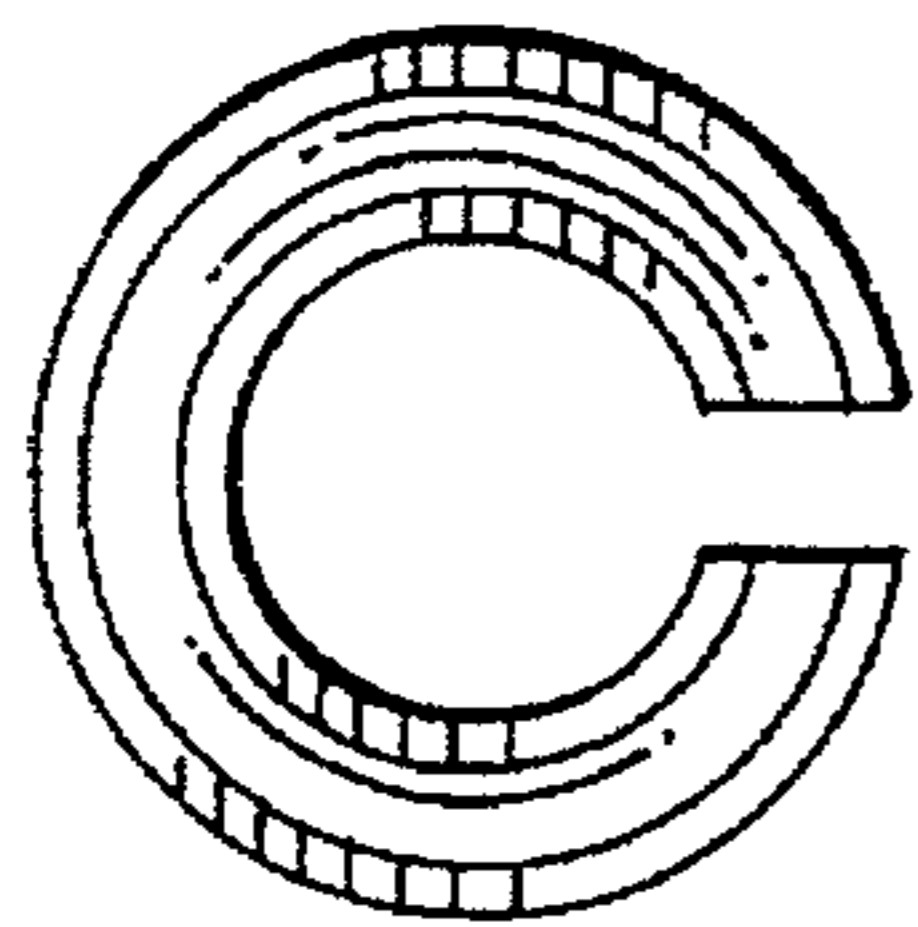

FIG. 5

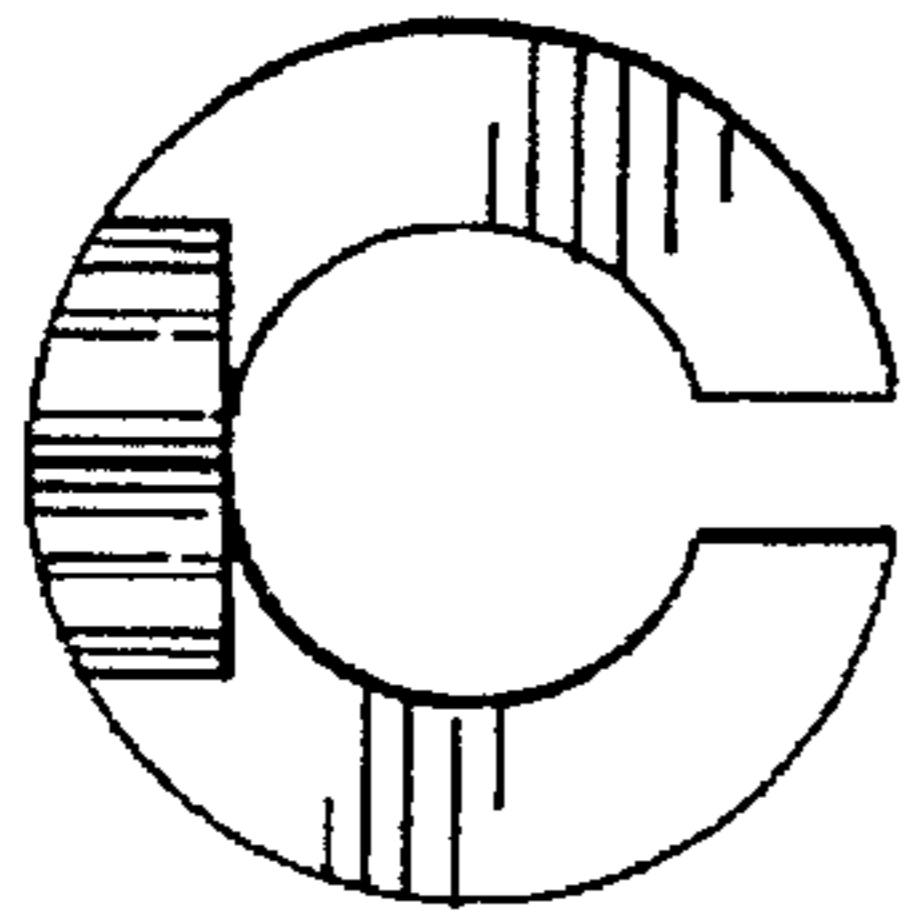

FIG. 6

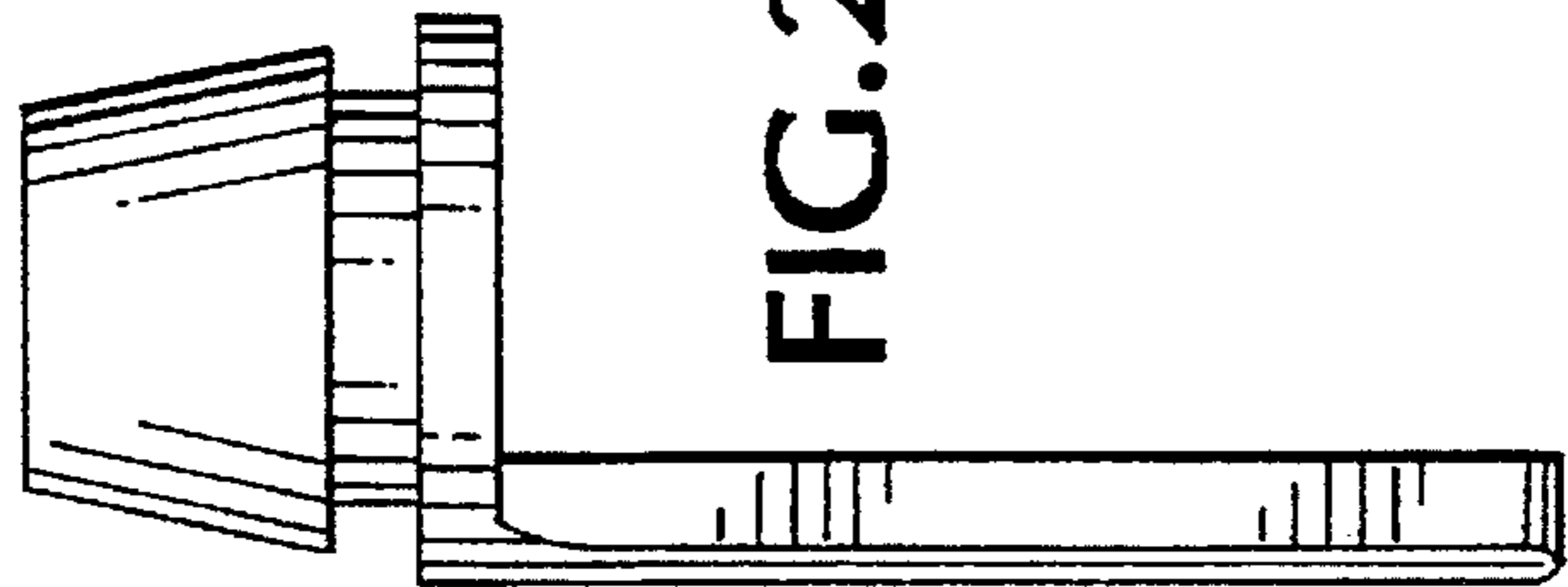

FIG. 2

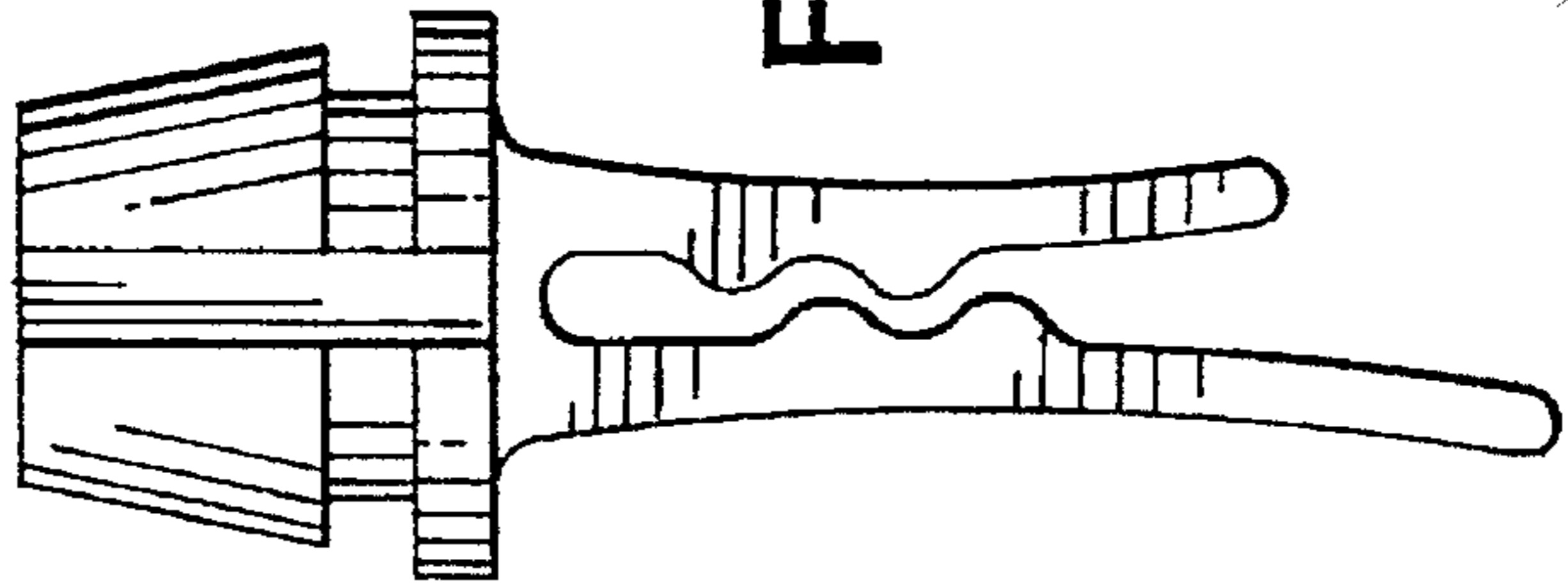

FIG. 1

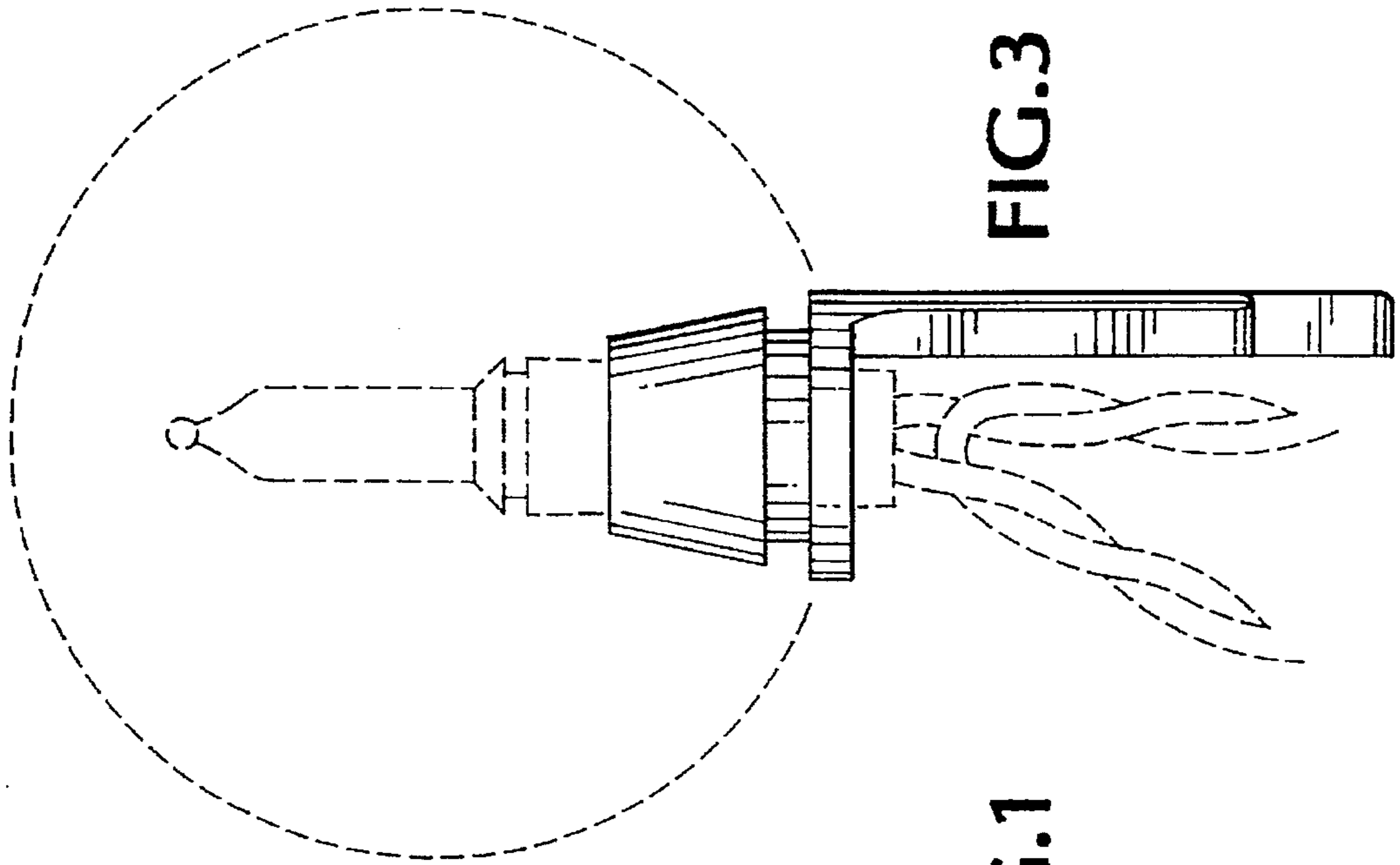

FIG. 3

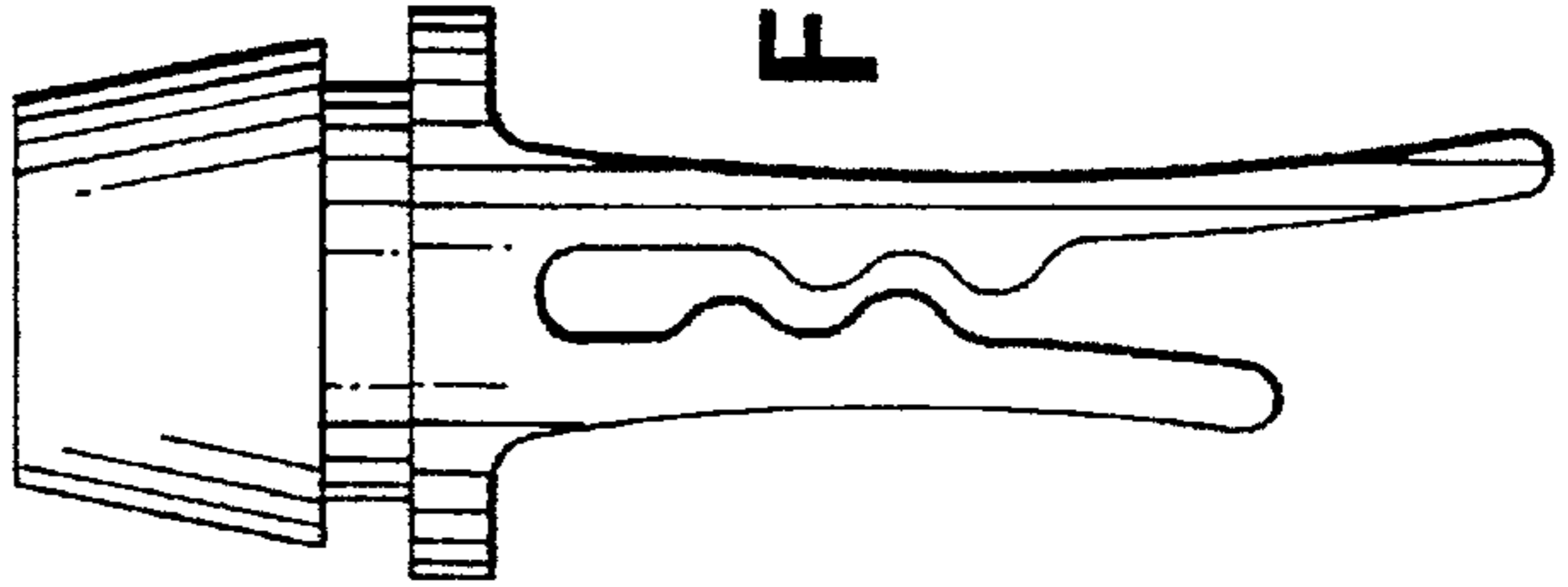

FIG. 4