



US00D379165S

United States Patent [19]

[11] Patent Number: **Des. 379,165**

Marozza et al.

[45] Date of Patent: ****May 13, 1997**

[54] **WAGON CONVERTED TO A STROLLER AND HAVING A REMOVABLE CONTAINER ATTACHED TO THE REAR THEREOF**

4,834,415 5/1989 Yee D12/129
5,417,449 5/1995 Shamie 280/642

[76] Inventors: **Anthony Marozza; Sharon L. Marozza**, both of 237 N. Wisconsin Ave., Villa Park, Ill. 60181

Primary Examiner—Kay H. Chin
Attorney, Agent, or Firm—Patnaude, Videbeck & Marsh

[**] Term: **14 Years**

[57] **CLAIM**

[21] Appl. No.: **42,836**

The ornamental design for a wagon converted to a stroller and having a removable container attached to the rear thereof, as shown and described.

[22] Filed: **Aug. 18, 1995**

DESCRIPTION

[51] LOC (6) Cl. **12-12**

[52] U.S. Cl. **D12/129**

[58] Field of Search D12/129; D34/12, D34/17; 280/642, 658, 47.35

FIG. 1 is a top elevational view of a wagon converted to a stroller and having a canopy and a removable container attached to the rear thereof;

FIG. 2 is a right elevational view thereof;

FIG. 3 is a front elevational view thereof;

FIG. 4 is a left side elevational view thereof;

FIG. 5 is a rear plan view thereof; and,

FIG. 6 is a bottom plan view thereof.

[56] **References Cited**

U.S. PATENT DOCUMENTS

D. 145,468 8/1946 Spence D12/129
D. 321,850 11/1991 Mong-Hsing D12/129

1 Claim, 2 Drawing Sheets

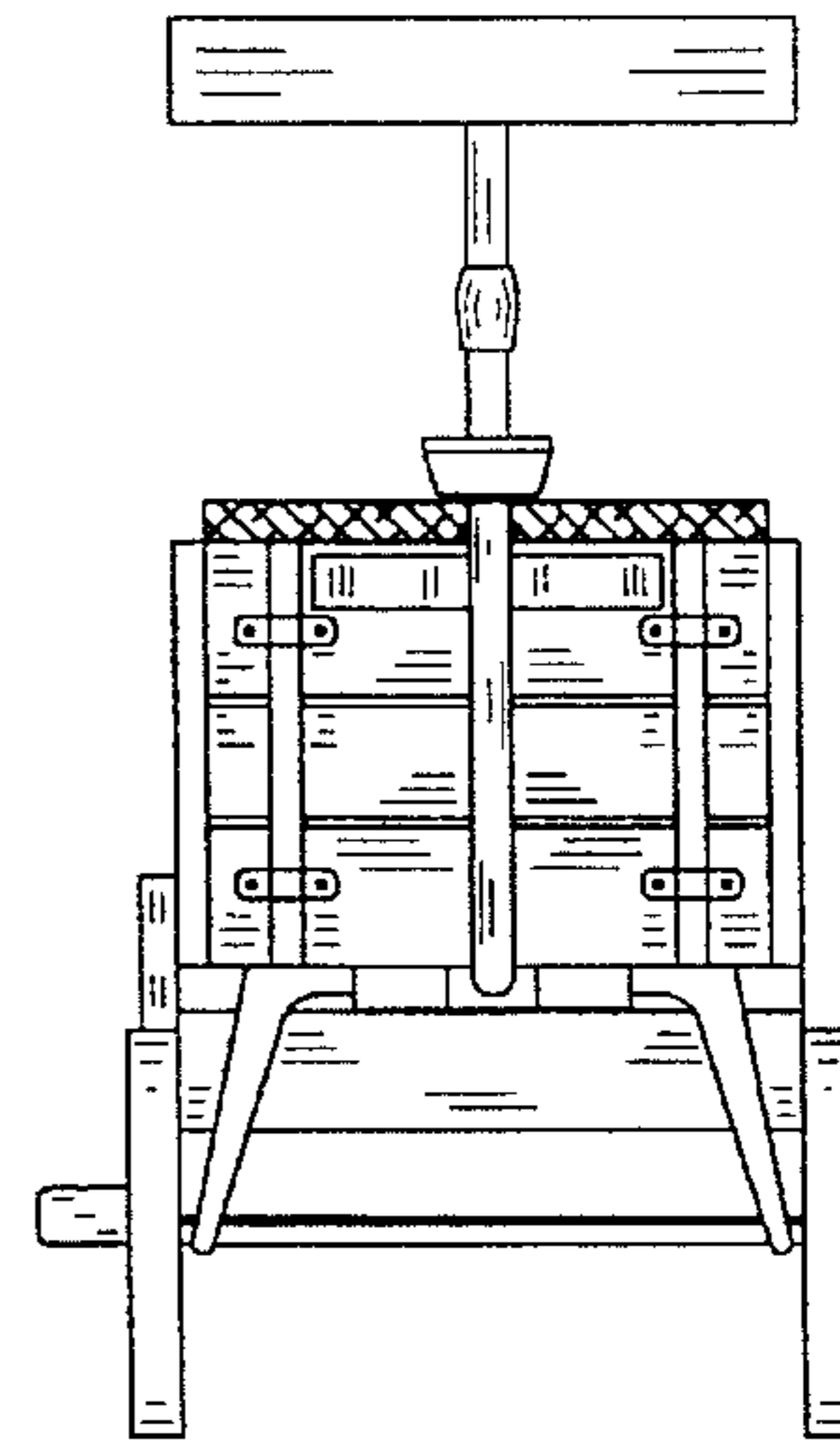
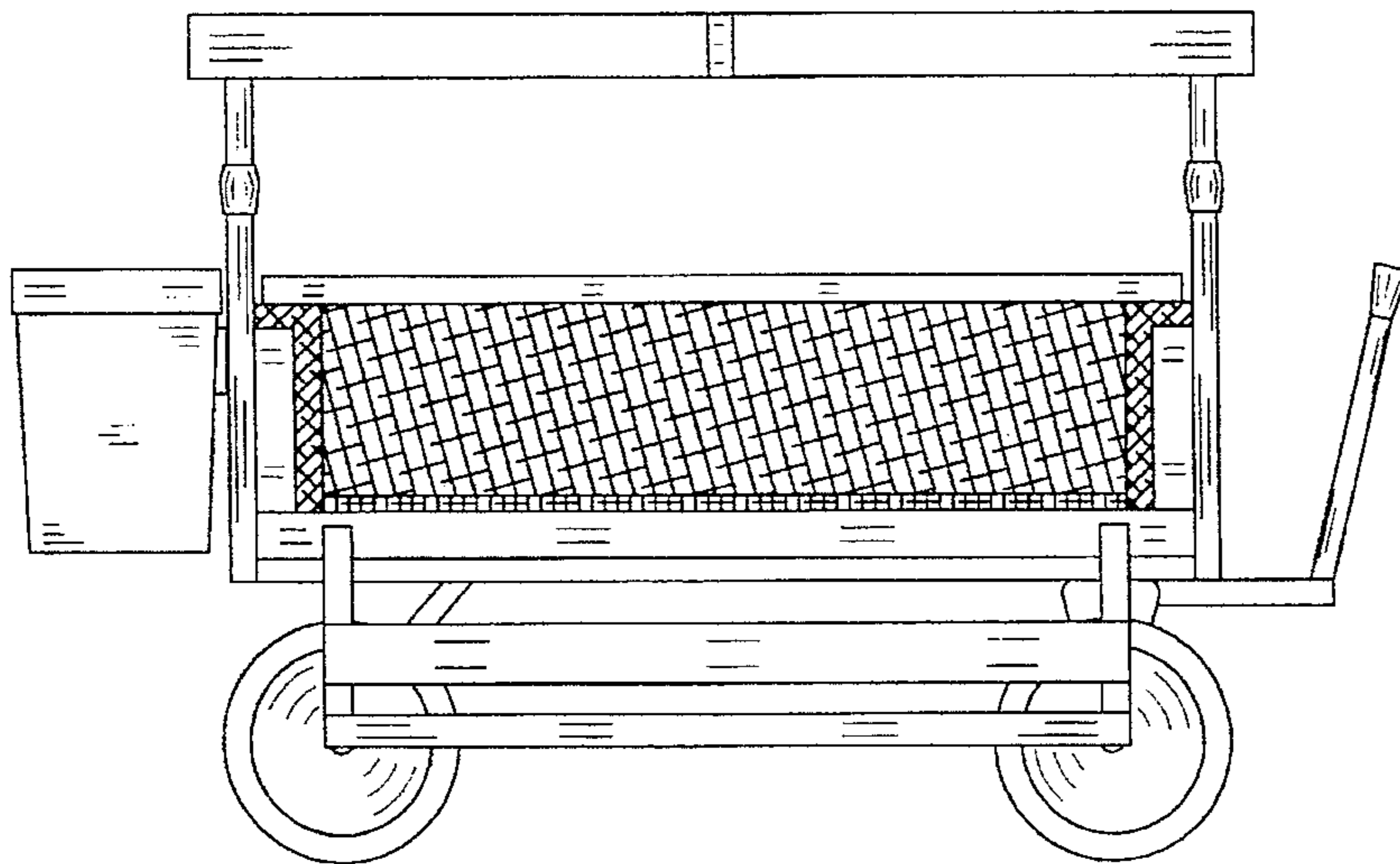

FIG. 1

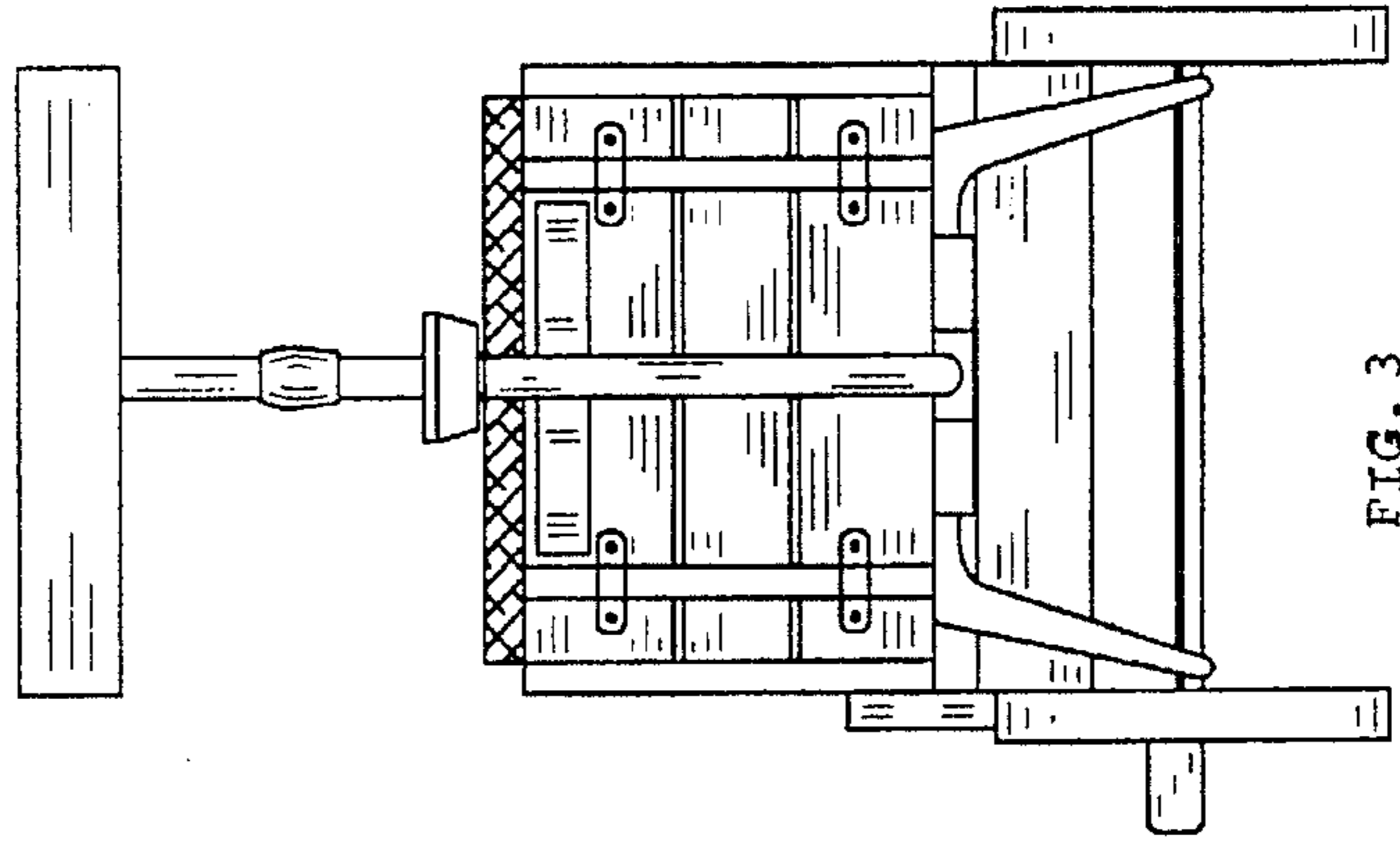
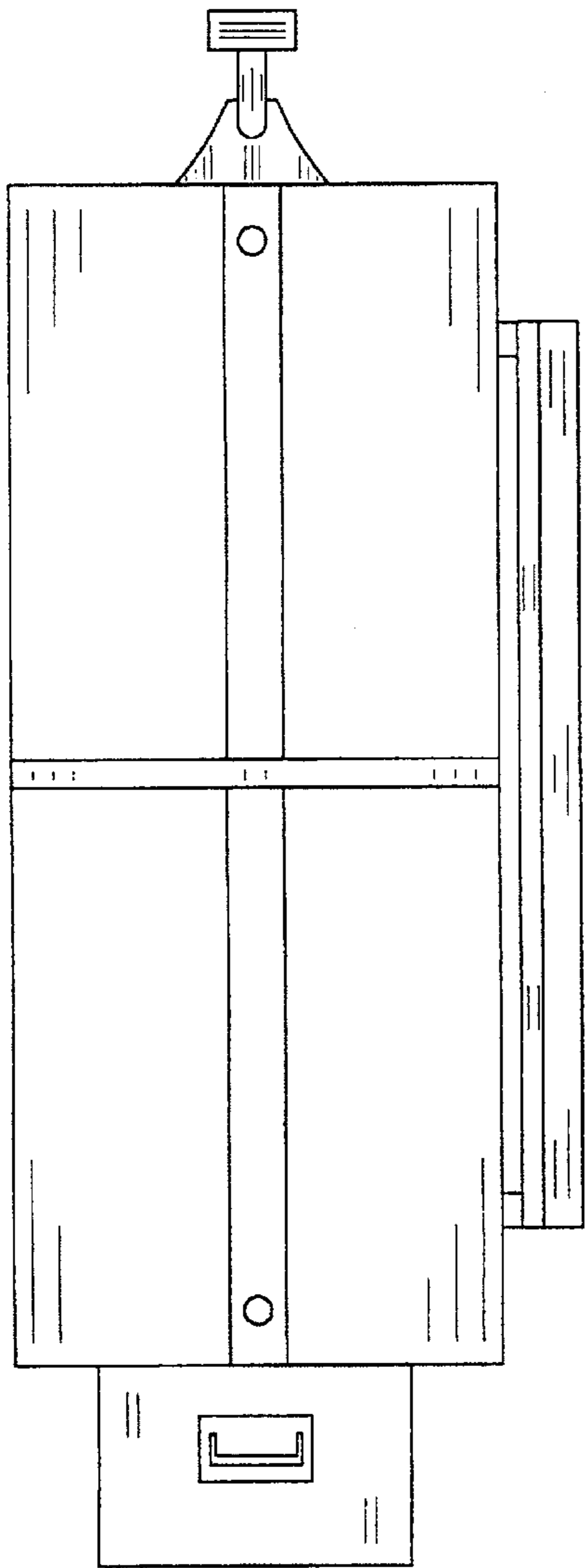

FIG. 3

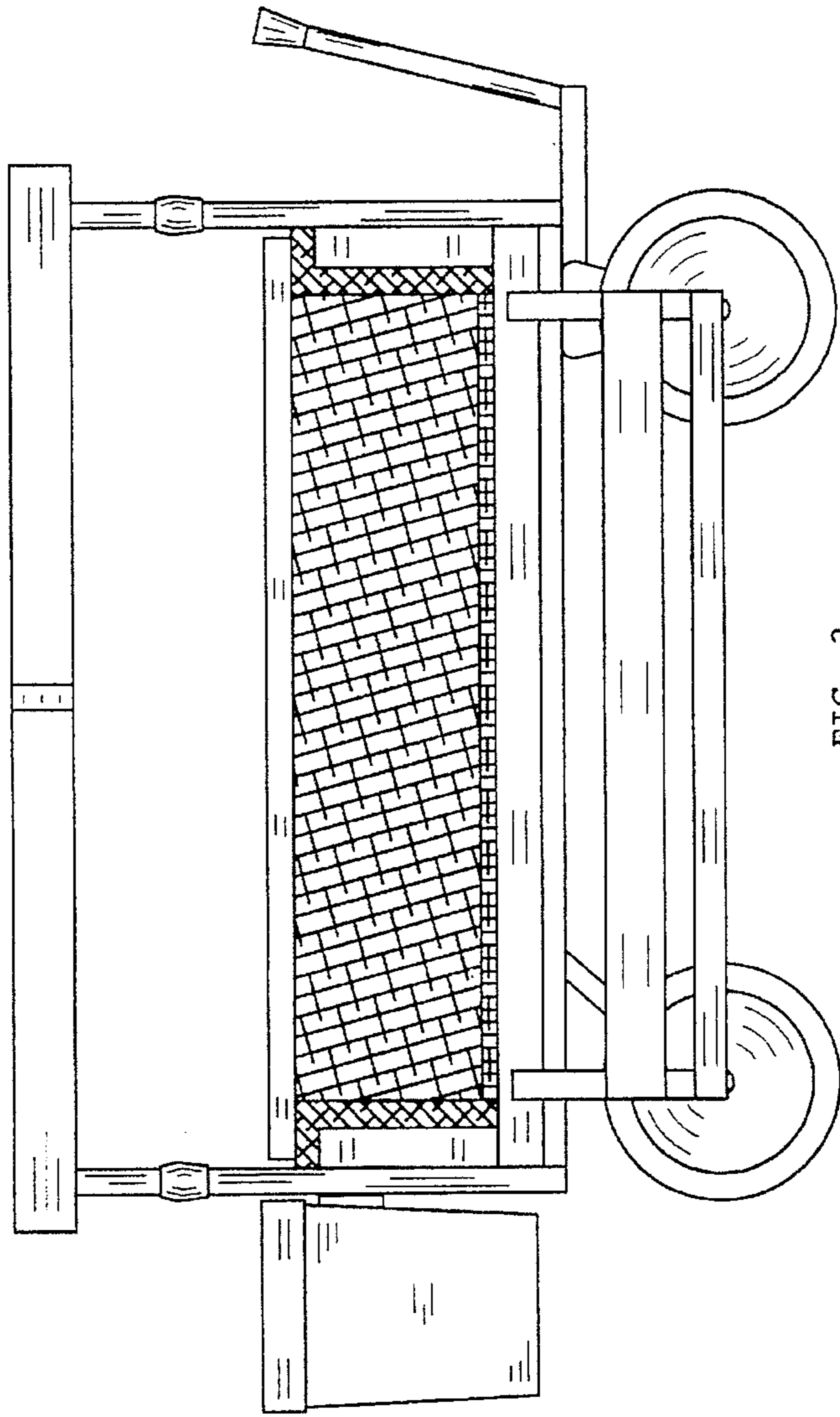

FIG. 2

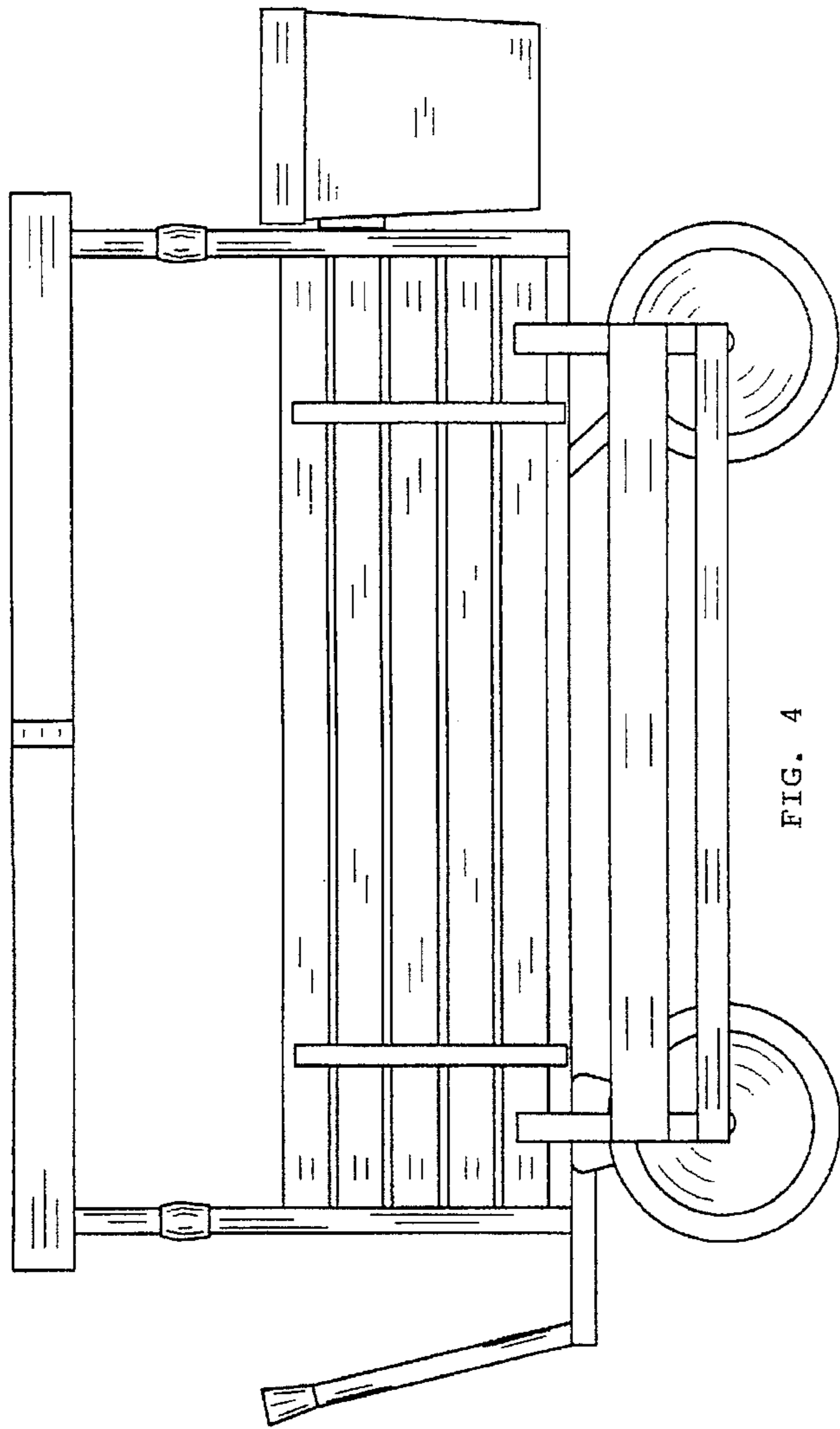

FIG. 4

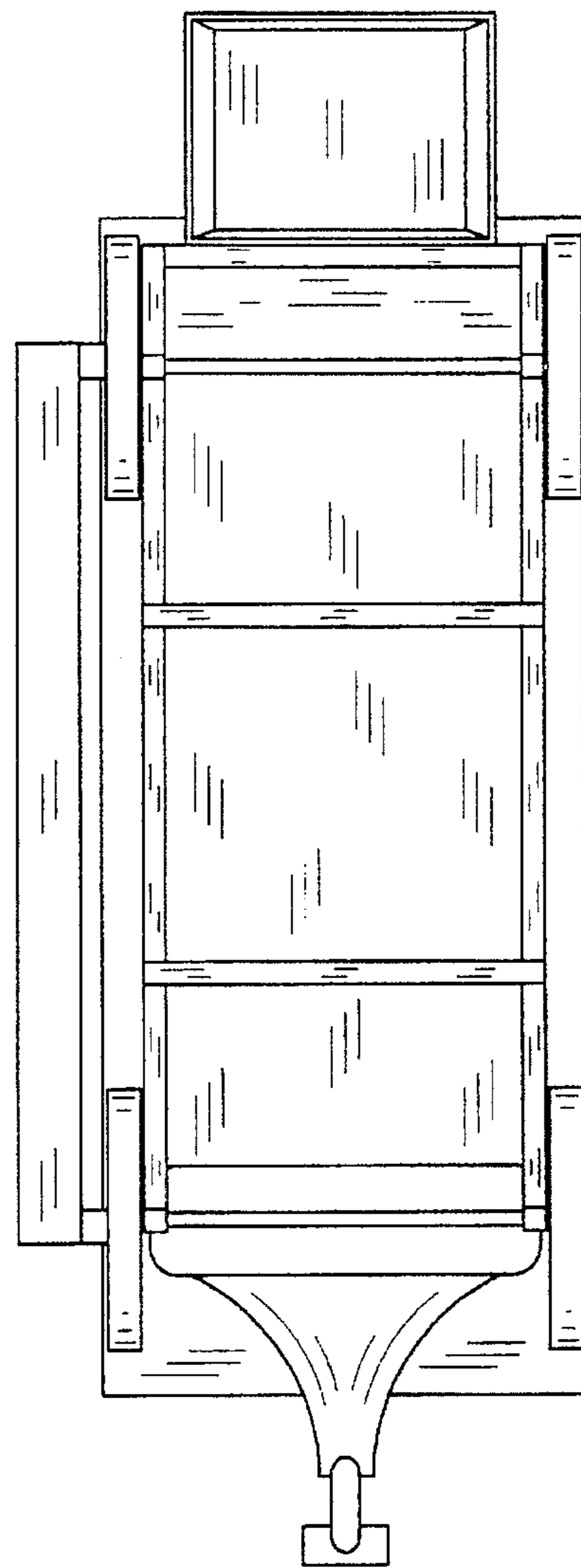

FIG. 6

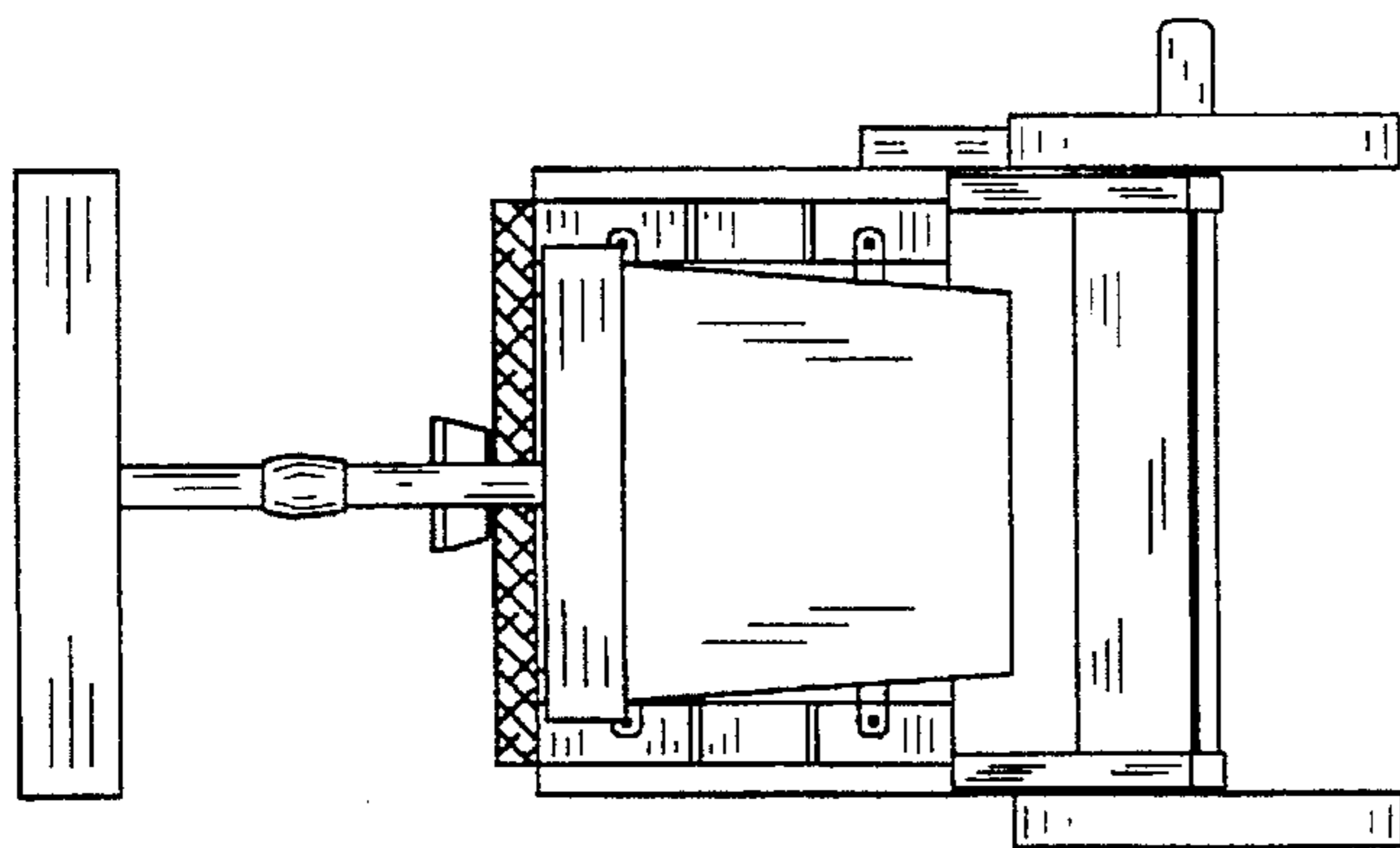

FIG. 5