

US00D379106S

United States Patent [19]
Maltby

[11] **Patent Number: Des. 379,106**

[45] **Date of Patent: **May 6, 1997**

[54] **GOLF CLUB HEAD**

[75] Inventor: **Ralph D. Maltby**, Granville, Ohio

[73] Assignee: **Ralph Maltby Enterprises, Inc.**,
Newark, Ohio

[**] Term: **14 Years**

[21] Appl. No.: **46,453**

[22] Filed: **Nov. 15, 1995**

[51] **LOC (6) Cl. 21-02**

[52] **U.S. Cl. D21/220**

[58] **Field of Search D21/220; 473/350,**
473/324, 327, 328, 330, 331

[56] **References Cited**

U.S. PATENT DOCUMENTS

D. 354,537	1/1995	Takahashi et al.	D21/220
1,617,090	2/1927	Worthington	473/328
3,079,157	2/1963	Turner	473/350 X
4,836,550	6/1989	Kobayashi	473/350

OTHER PUBLICATIONS

Golf World; p. 30; Ultra iron, bottom of page May 1990.
Golf Digest; p. 145; Wilson iron, top middle of page Dec.
1989.

Primary Examiner—Ted Shooman

Assistant Examiner—Mitchell I. Siegel

Attorney, Agent, or Firm—Killworth, Gottman, Hagan &
Schaeff

[57] **CLAIM**

The ornamental design for a golf club head, as shown and
described.

DESCRIPTION

FIG. 1 is a perspective view of a golf club head illustrating
my new design;

FIG. 2 is a toe end elevational view of the design shown in
FIG. 1;

FIG. 3 is a heel end elevational view of the design shown in
FIG. 1;

FIG. 4 is a top plan view of the design of FIG. 1;

FIG. 5 is a bottom view of the design of FIG. 1;

FIG. 6 is a front elevational view of the design of FIG. 1;
and,

FIG. 7 is a rear elevational view of the design of FIG. 1.

1 Claim, 2 Drawing Sheets

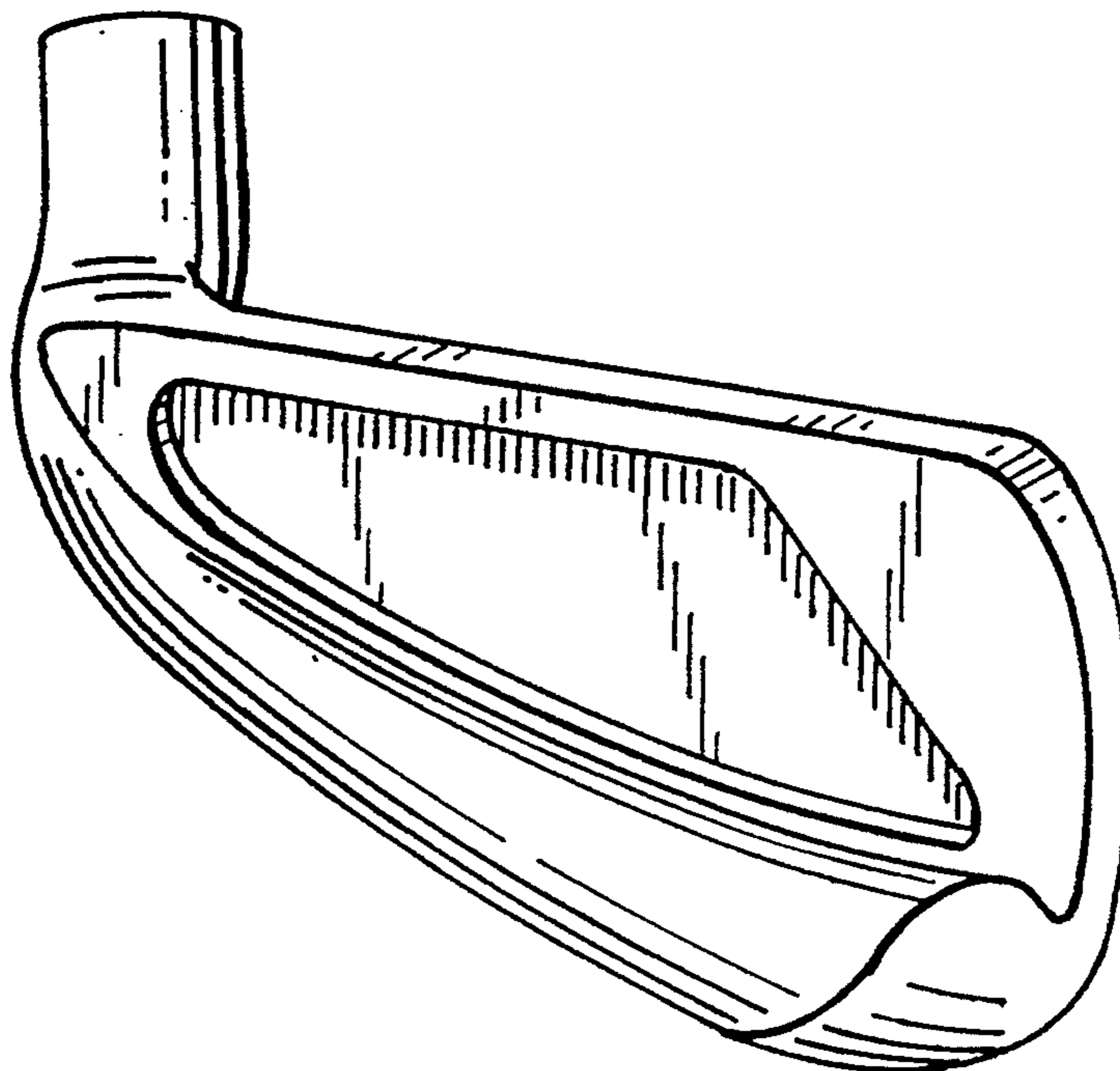

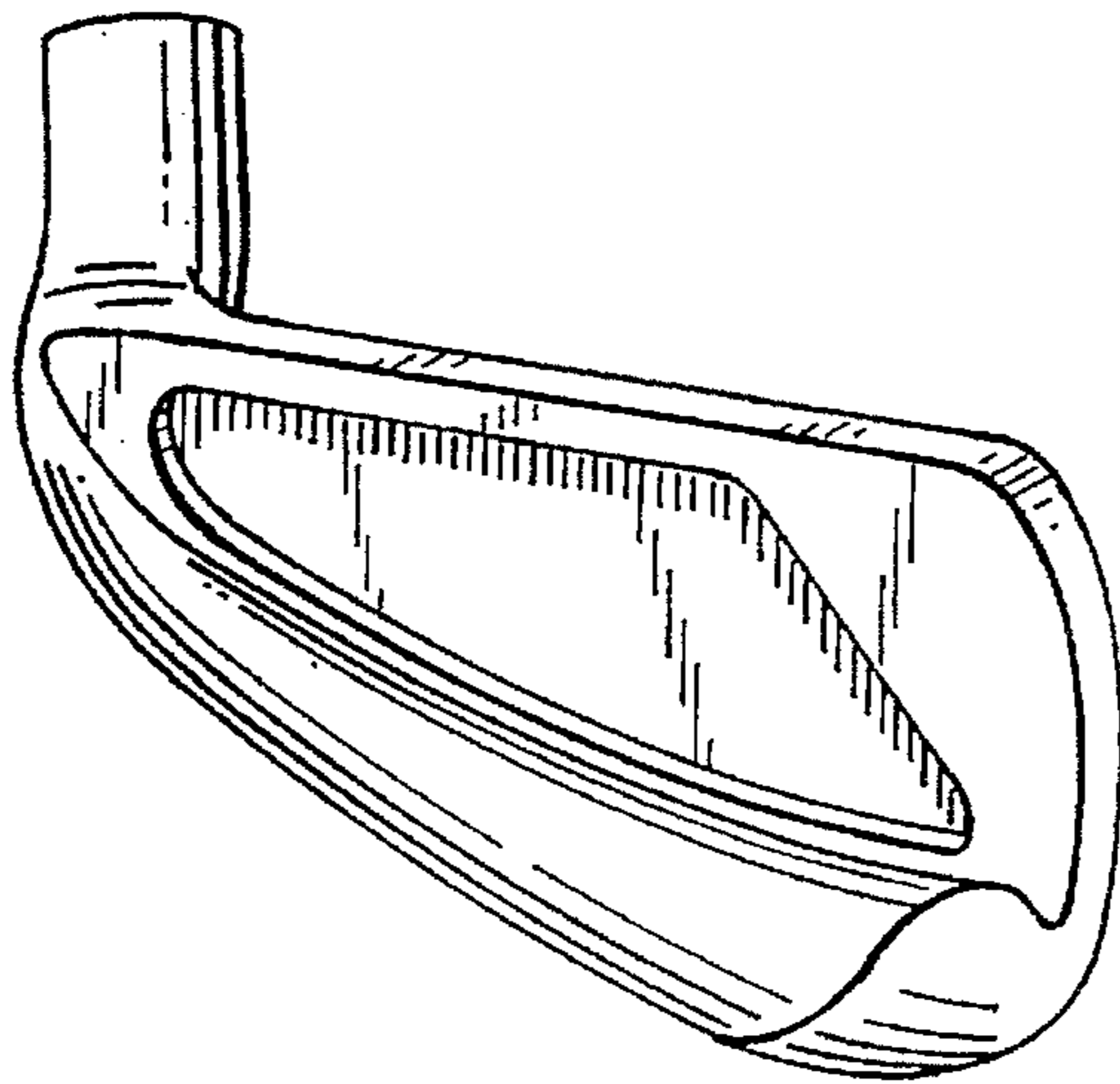

FIG. 1

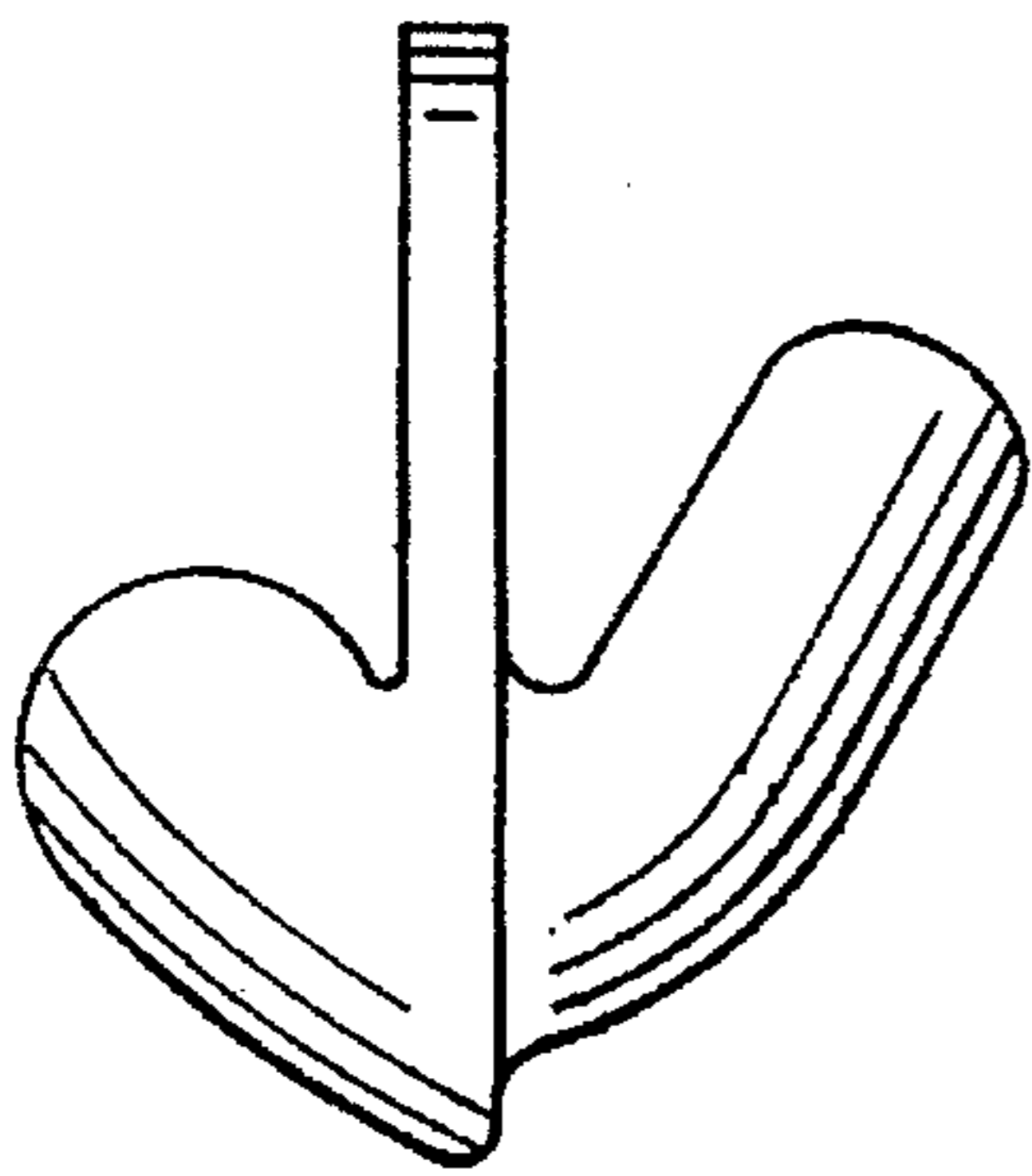

FIG. 2

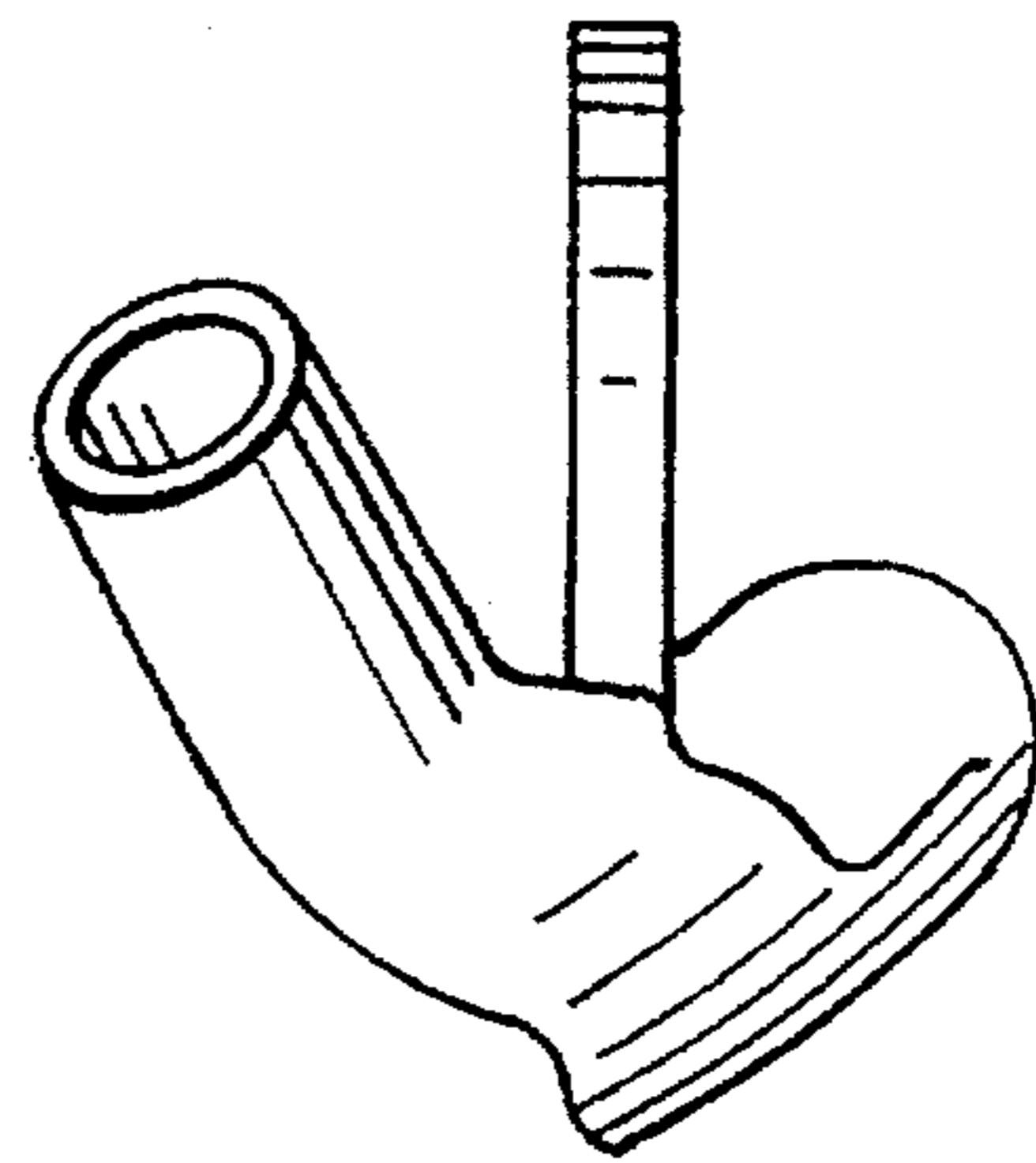

FIG. 3

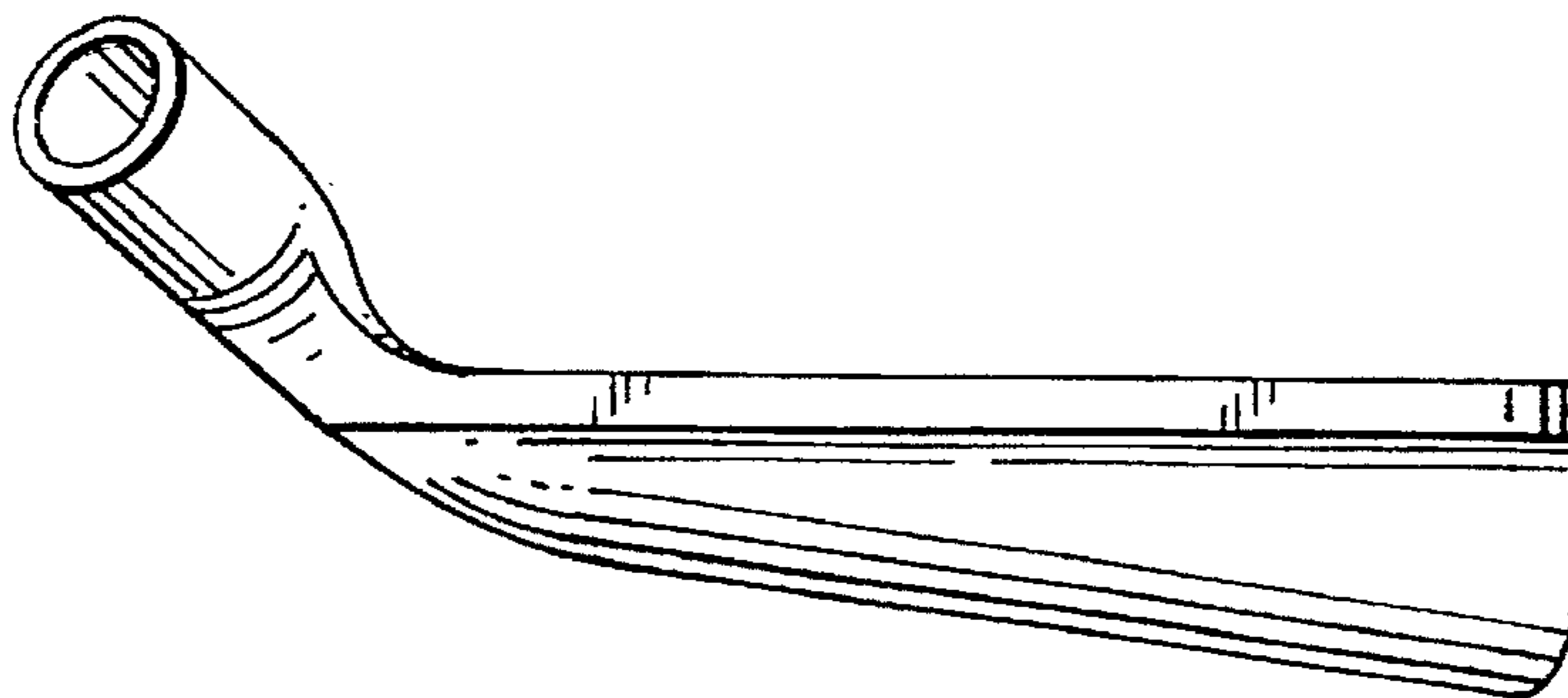

FIG. 4

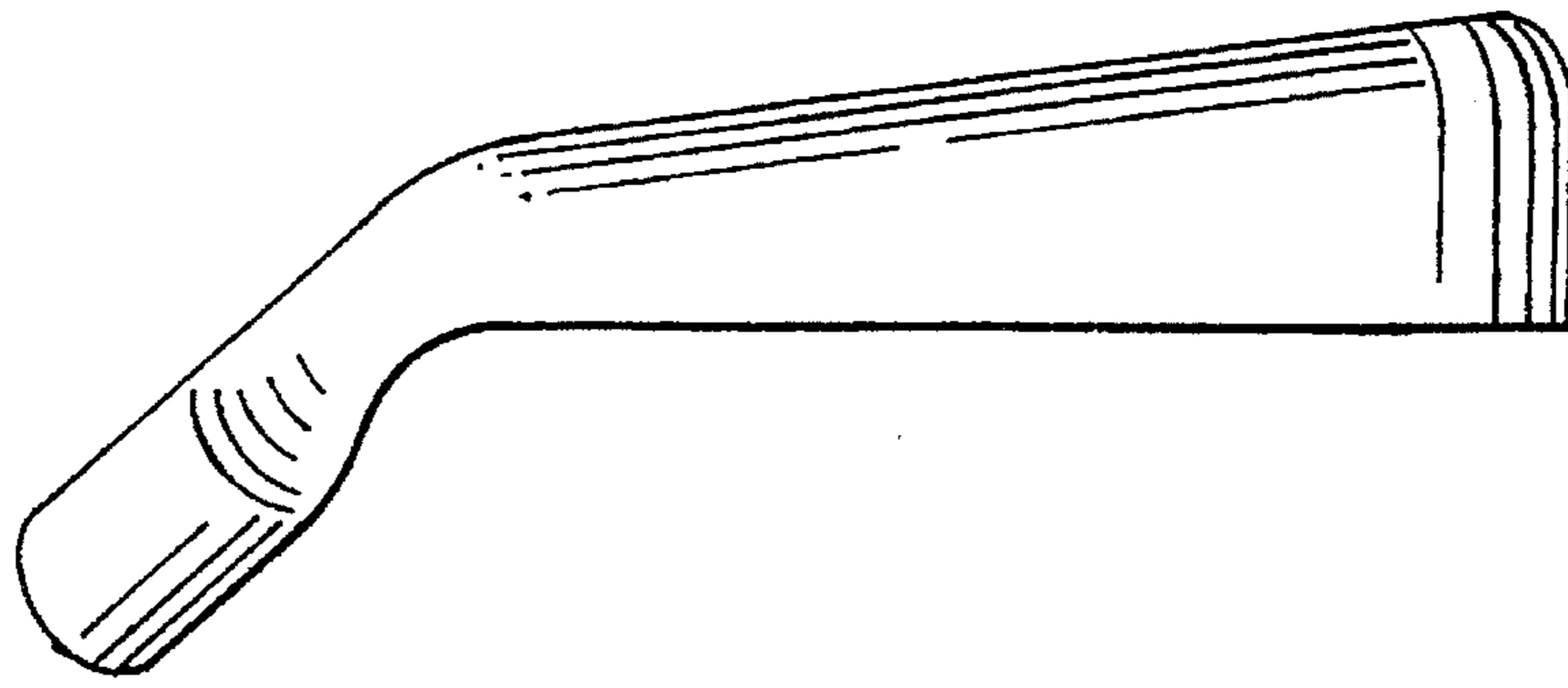

FIG. 5

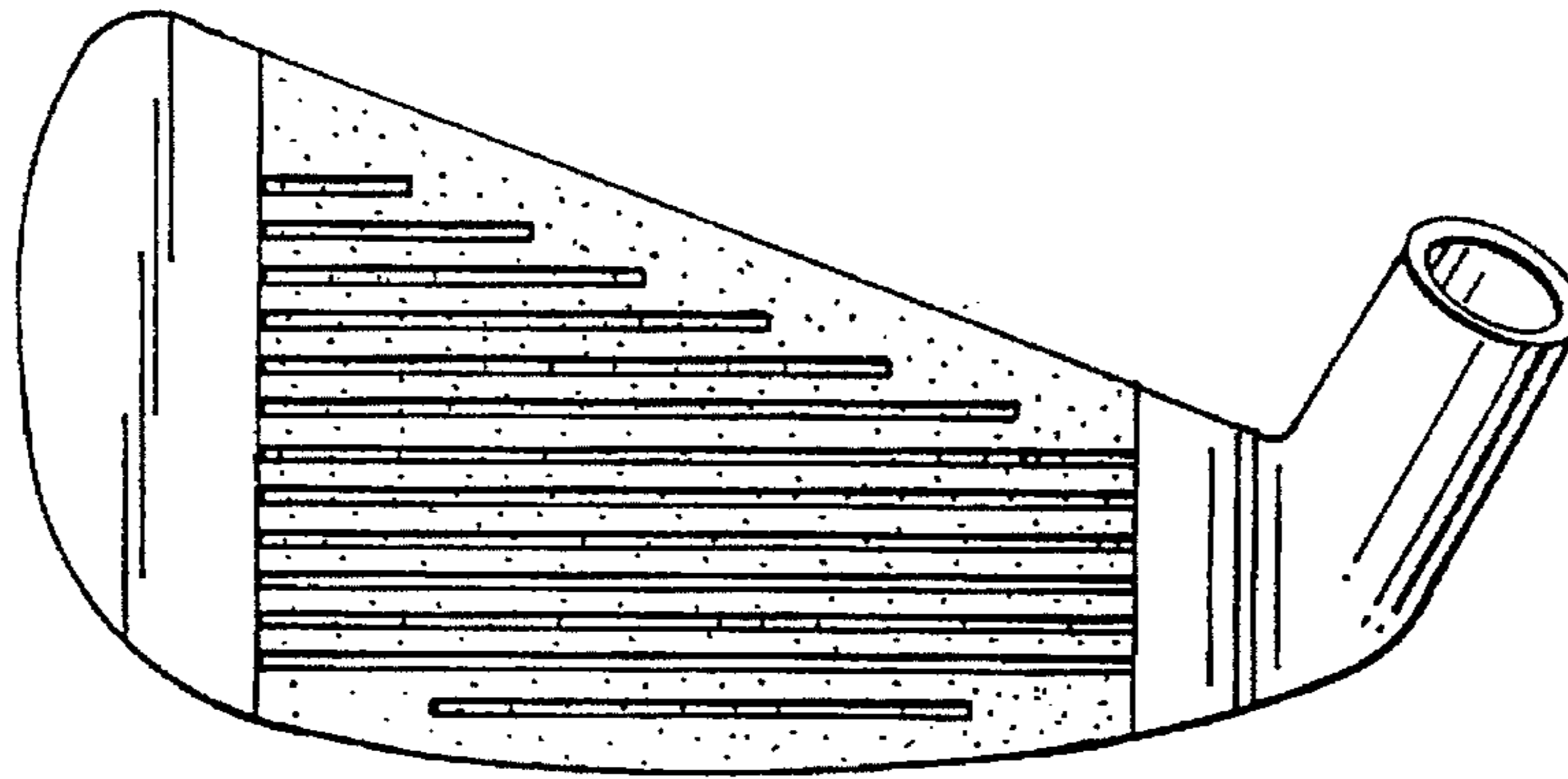

FIG. 6

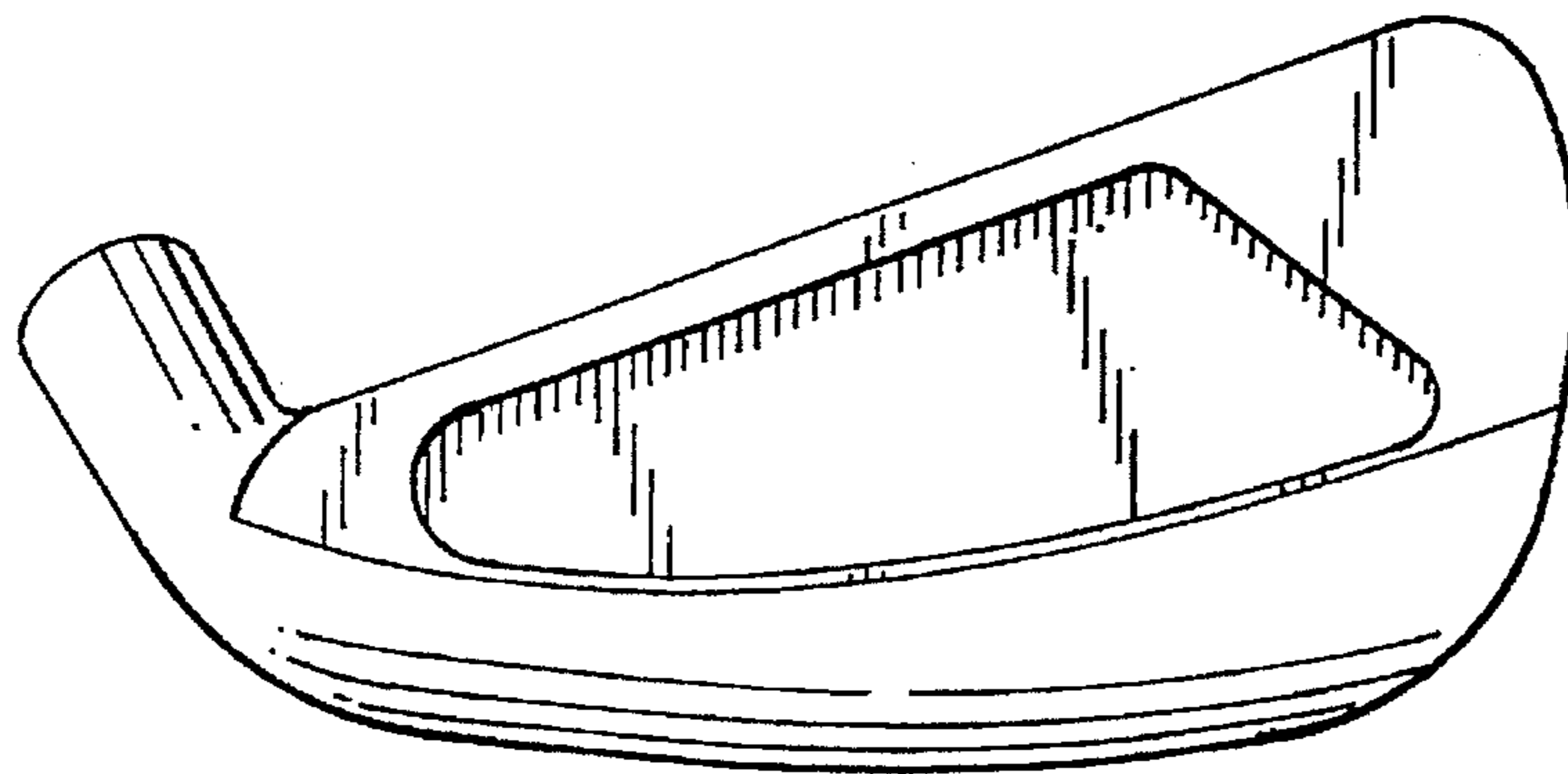

FIG. 7