



US00D379081S

United States Patent [19]

[11] Patent Number: **Des. 379,081**

Wilson

[45] Date of Patent: ****May 6, 1997**

[54] **CHAIN-WEIGHTED TARP**

[57] **CLAIM**

[76] Inventor: **George P. Wilson**, Rte. 1, Box 109A, Cunningham, Kans. 67035

The ornamental design for a chain-weighted tarp, as shown and described.

[**] Term: **14 Years**

DESCRIPTION

[21] Appl. No.: **20,791**

FIG. 1 is a top, front and left side perspective view of a chain-weighted tarp showing my new design, the wheels shown in broken lines are for illustrative purposes only and form no part of the claimed design;

[22] Filed: **Mar. 28, 1994**

FIG. 2 is a top plan view thereof;

[51] LOC (6) Cl. **12-16**

FIG. 3 is a bottom plan view thereof;

[52] U.S. Cl. **D12/401**

FIG. 4 is a front elevational view thereof, the rear being a mirror image thereof;

[58] Field of Search D12/401; 296/95.1, 296/100, 136; 150/165, 166

FIG. 5 is a right side elevational thereof, the left side being a mirror image thereof;

[56] **References Cited**

U.S. PATENT DOCUMENTS

2,801,667	8/1967	Curran	150/166
4,825,889	5/1989	Monteith	296/136
5,102,183	4/1992	Swartz	296/136
5,188,417	2/1993	Curchod	296/136
5,242,206	9/1993	Heck	296/136

FIG. 6 is a top plan view of a chain-weighted tarp showing a second embodiment of my new design;

FIG. 7 is a bottom plan view of FIG. 6;

FIG. 8 is a fragmentary, top plan view of FIG. 6, with parts broken away illustrating the chain weight; and,

FIG. 9 is a fragmentary, bottom plan view of FIG. 6, with parts broken away illustrating the chain weight.

Primary Examiner—Melody N. Brown
Attorney, Agent, or Firm—Litman, McMahon and Brown, L.L.C.

1 Claim, 2 Drawing Sheets

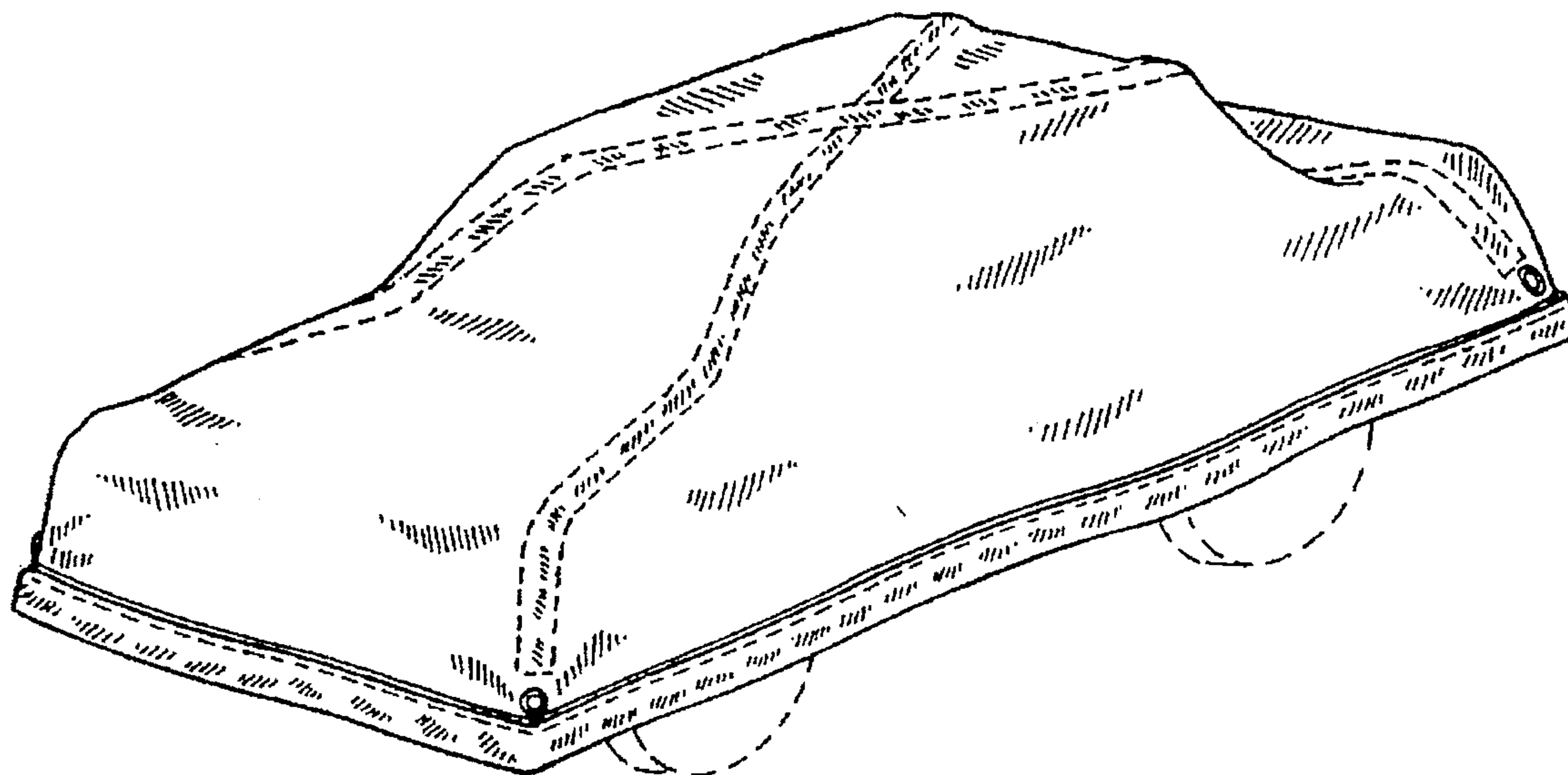

FIG. 1.

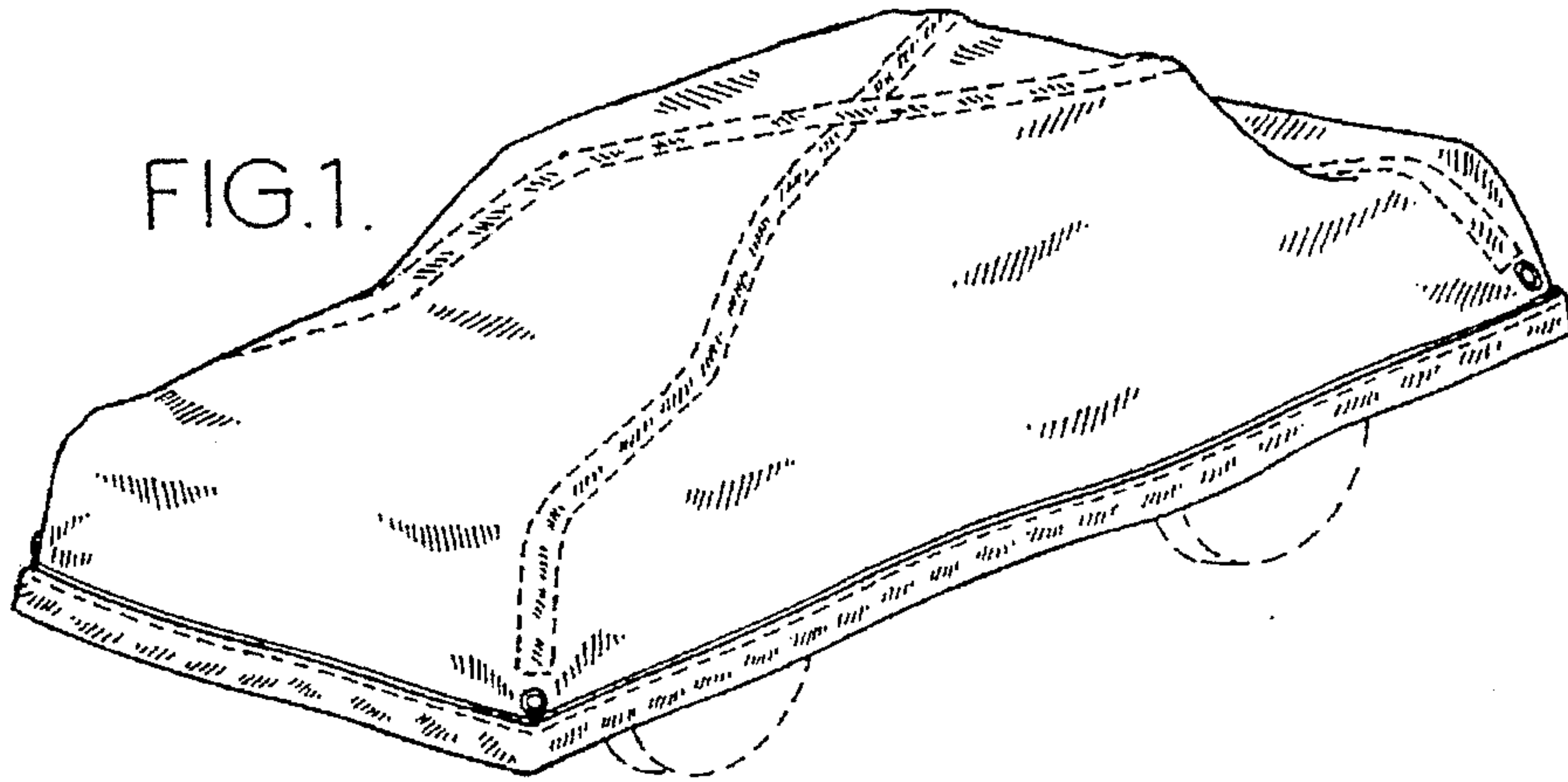

FIG. 2.

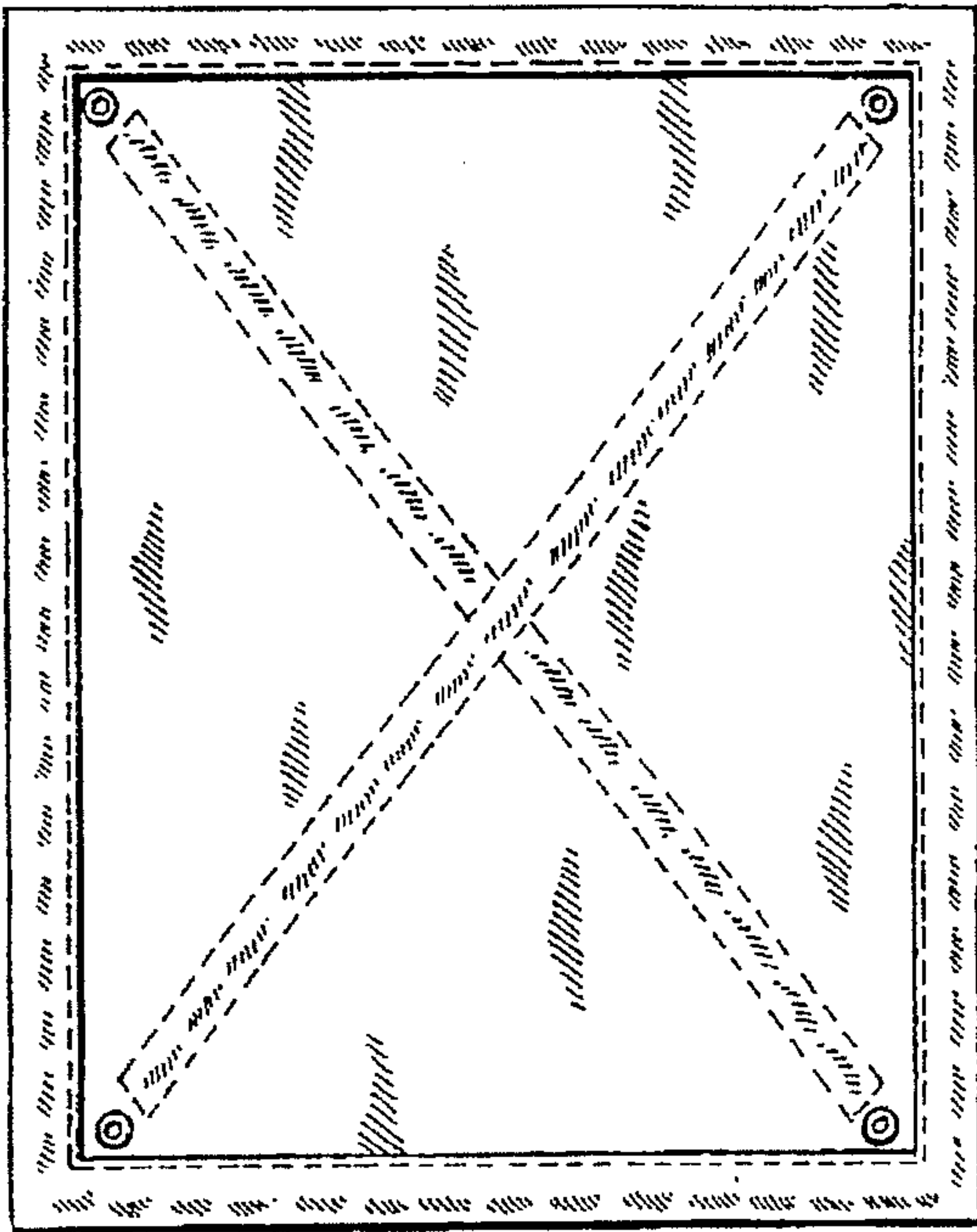

FIG. 3.

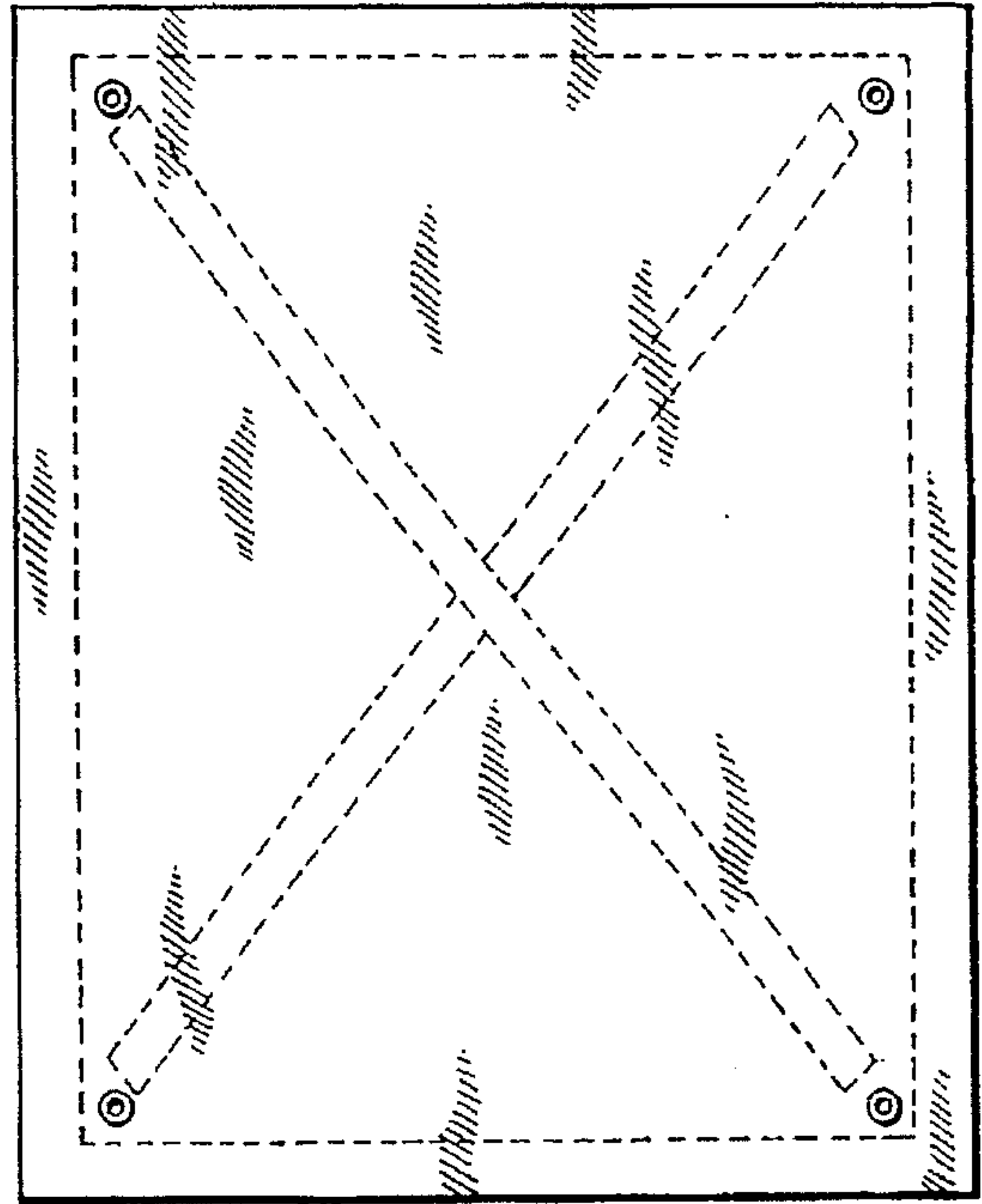

FIG. 4.

FIG. 6

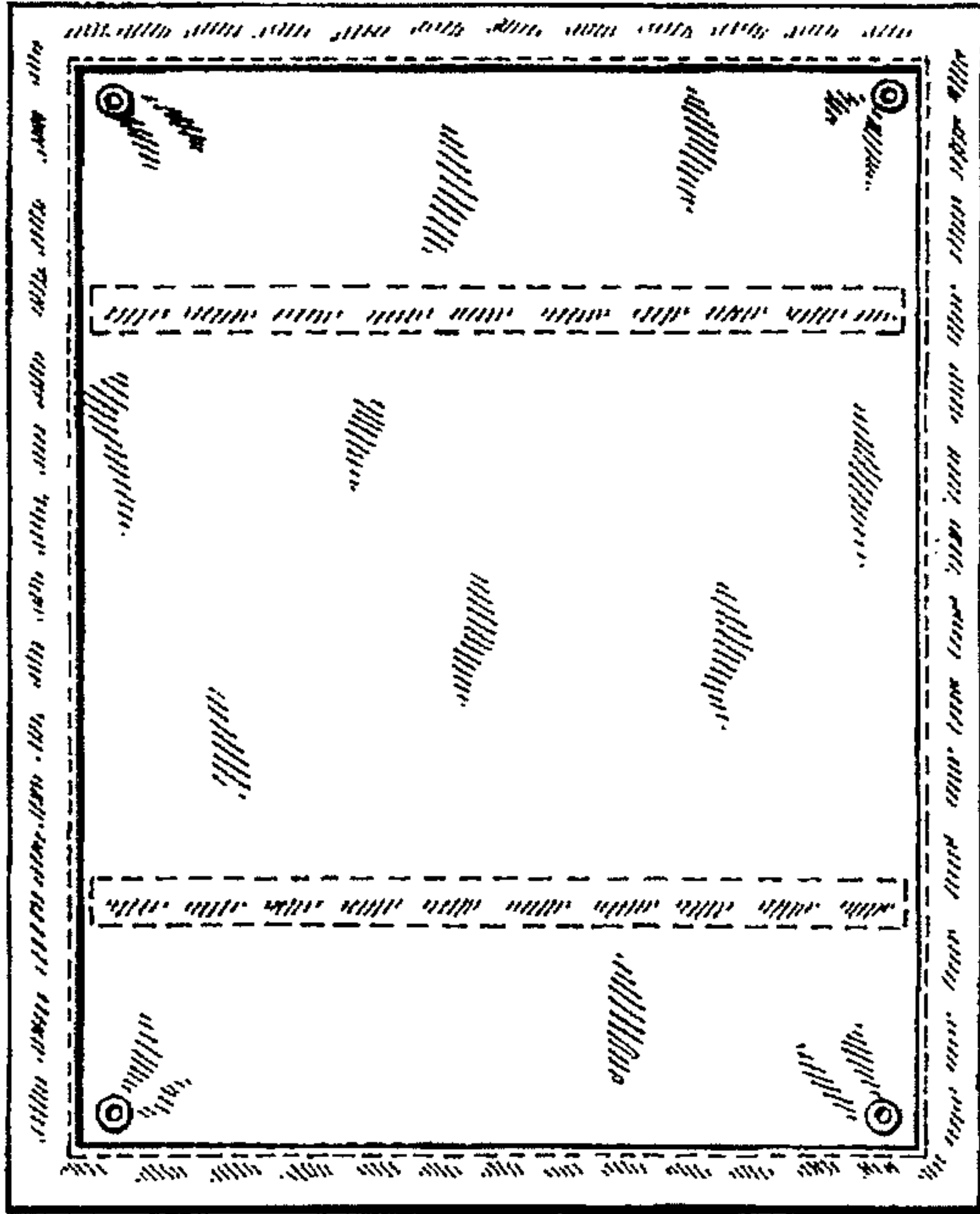

FIG. 7

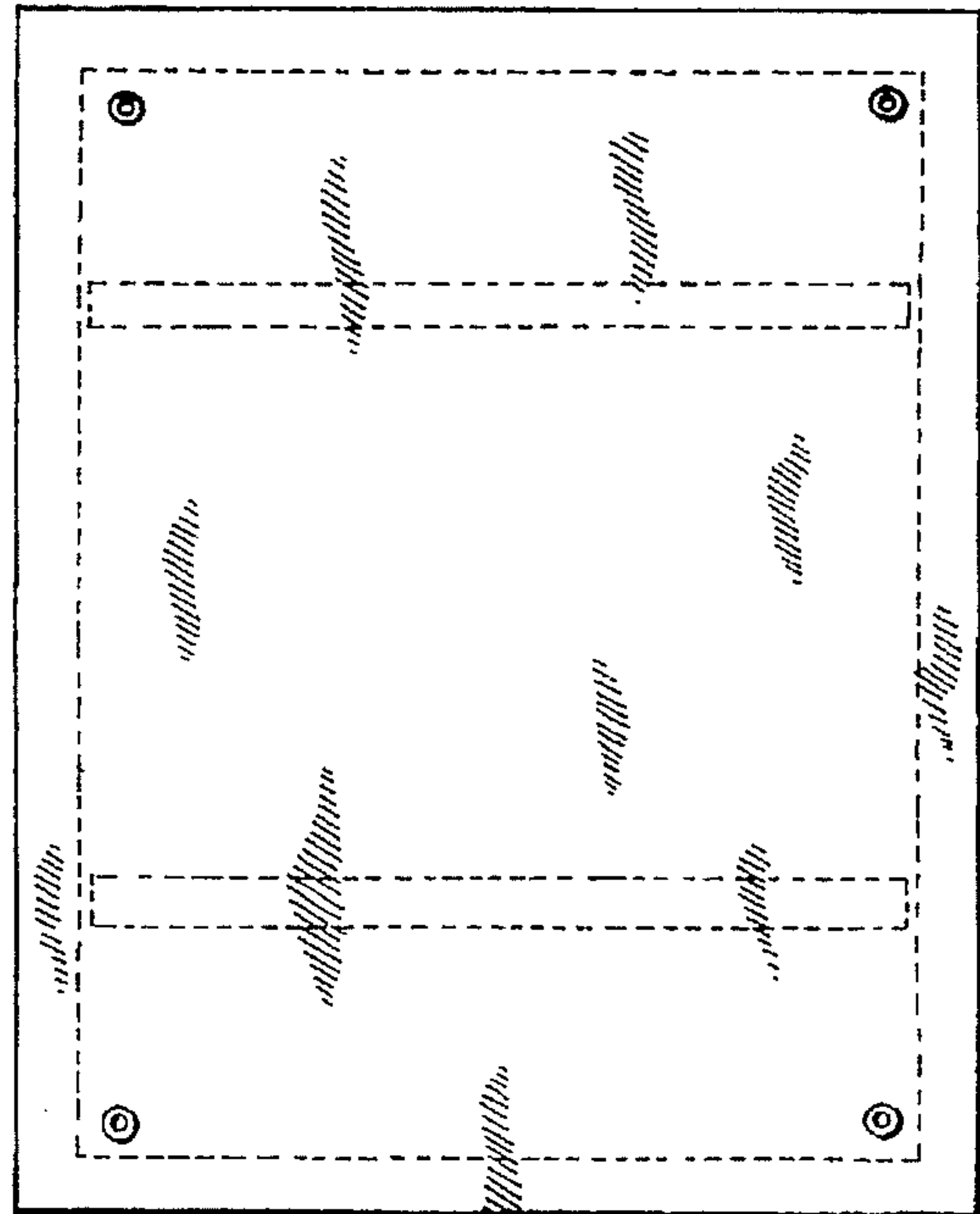

FIG. 9

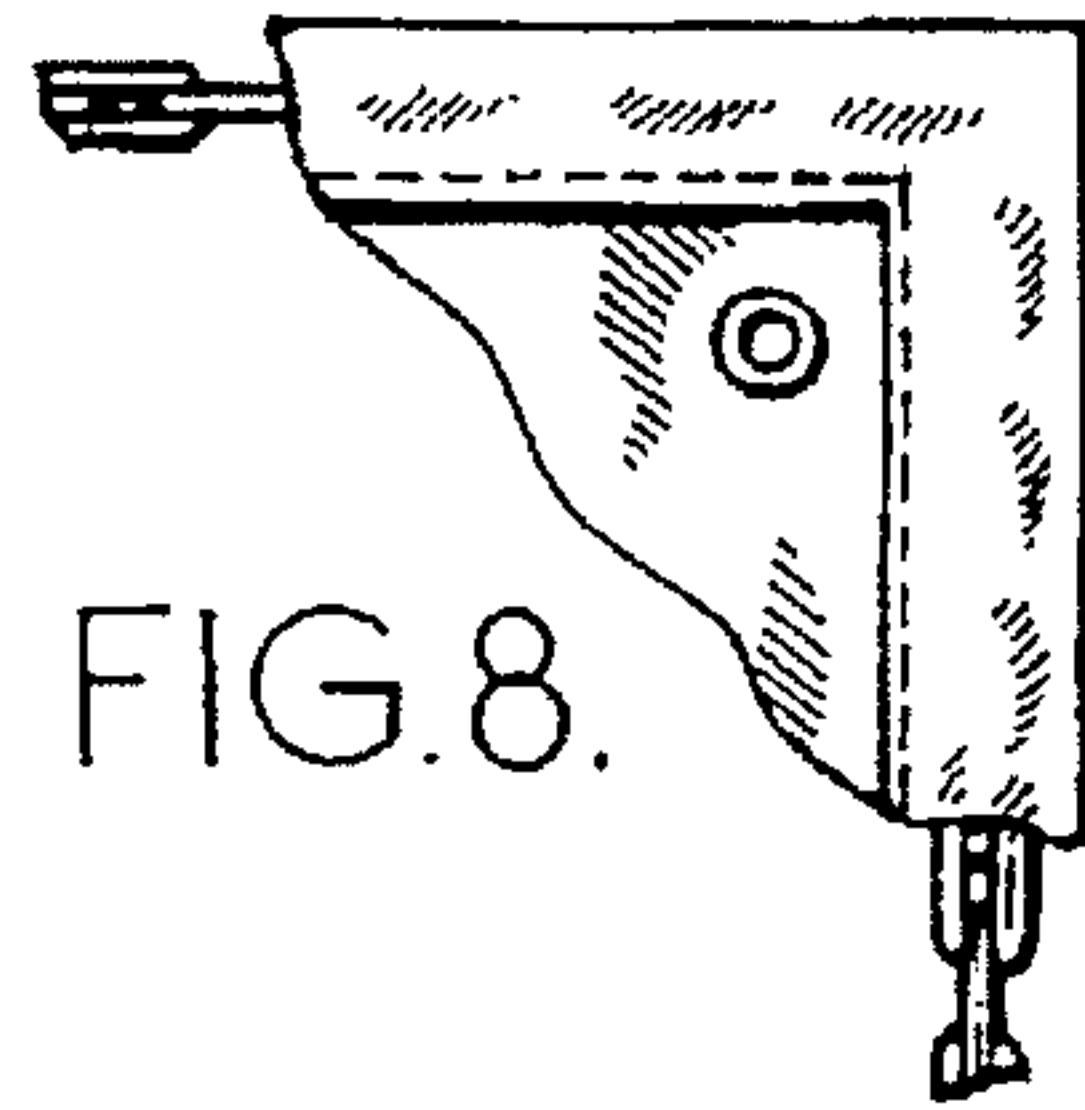
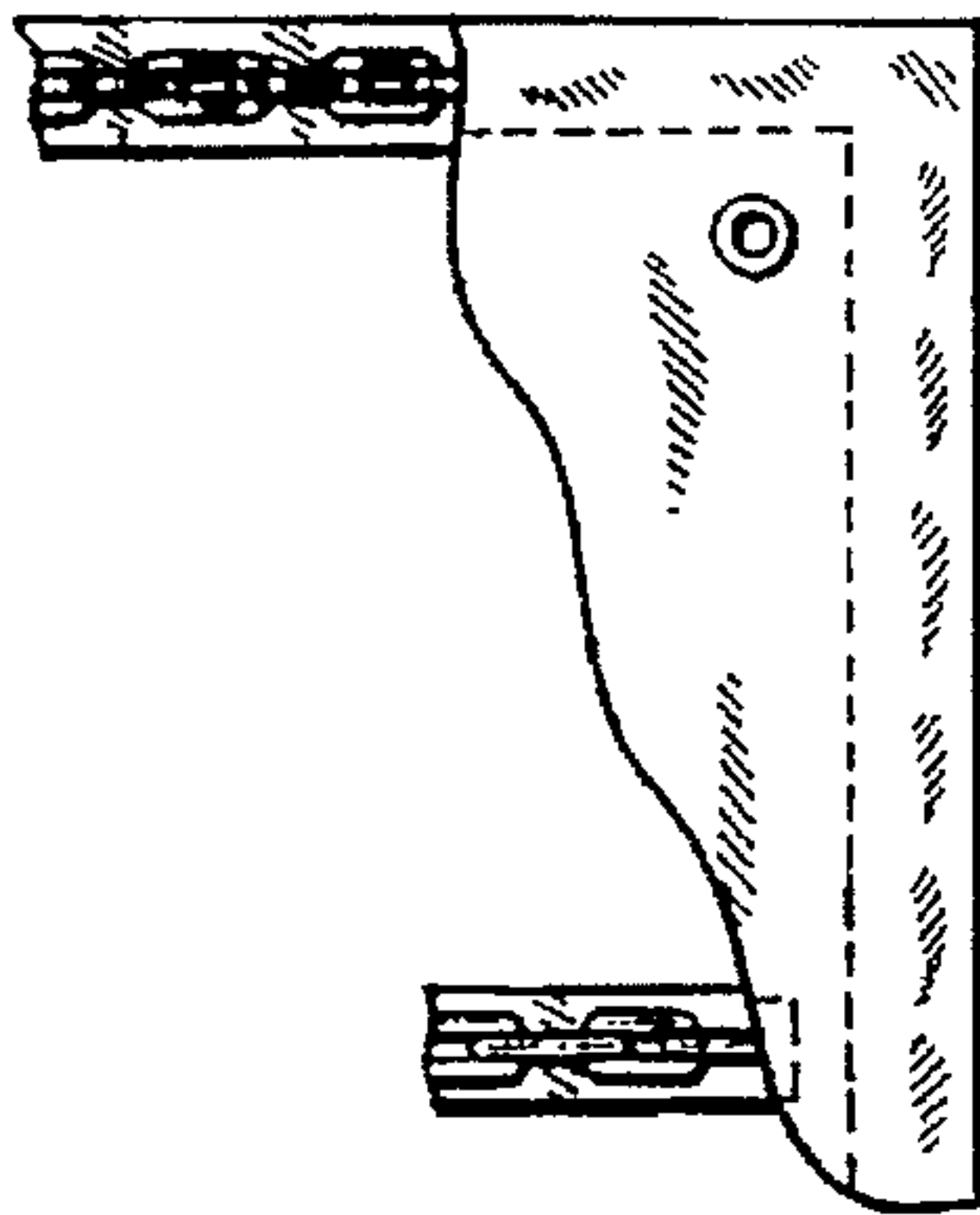

FIG. 8

FIG. 5

