



US00D379061S

United States Patent [19]
Williams

[11] **Patent Number:** **Des. 379,061**
[45] **Date of Patent:** ****May 6, 1997**

[54] **SUPPORT FOR A BED FRAME**

[76] **Inventor:** **Susan R. Williams**, 28649 S. Western Ave. #6757, Rancho Palos Verdes, Calif. 90734

[**] **Term:** **14 Years**

[21] **Appl. No.:** **34,967**

[22] **Filed:** **Feb. 16, 1995**

[51] **LOC (6) Cl.** **08-05**

[52] **U.S. Cl.** **D8/374**

[58] **Field of Search** D8/374; 248/346.01-346.5, 248/188.2; 16/42 R; 5/509; D6/495; D7/619, 624

[56] **References Cited**

U.S. PATENT DOCUMENTS

D. 44,996 12/1913 Buser D8/374

133,766	12/1872	Easterly	248/188.2
2,366,867	1/1945	Nichthausen	248/188.2
3,230,910	1/1966	Olsson	248/188.2 X
3,266,533	8/1966	McHale	248/346.5 X

Primary Examiner—Holly Baynham

[57] **CLAIM**

The ornamental design for support for a bed frame, as shown and described.

DESCRIPTION

FIG. 1 is a side elevational view of the support for a bed frame, the opposite sides and both end views of which are identical in appearance;
FIG. 2 is a top plan view;
FIG. 3 is a bottom plan view; and,
FIG. 4 is a sectional view from line 4—4 of FIG. 1.

1 Claim, 1 Drawing Sheet

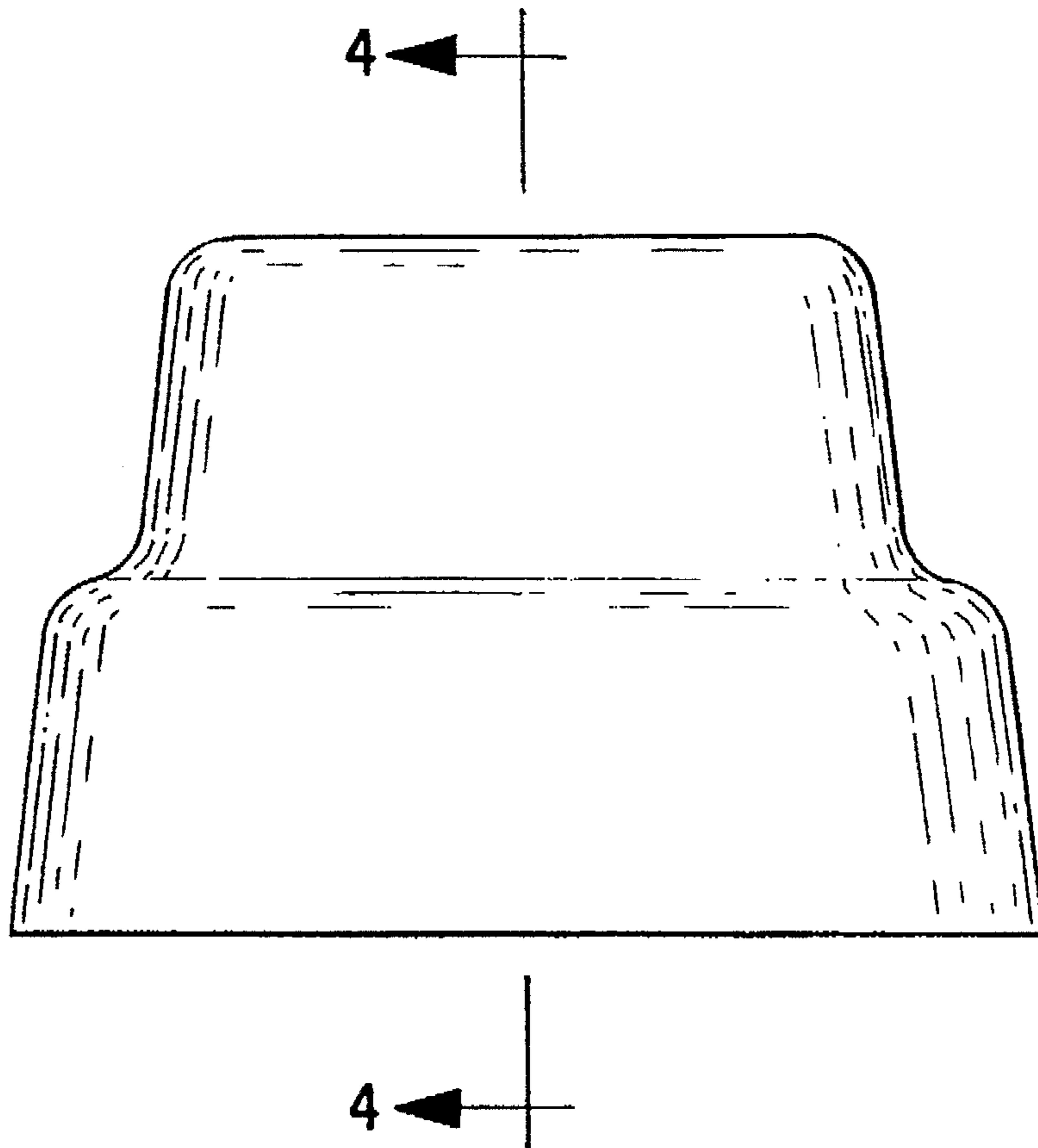

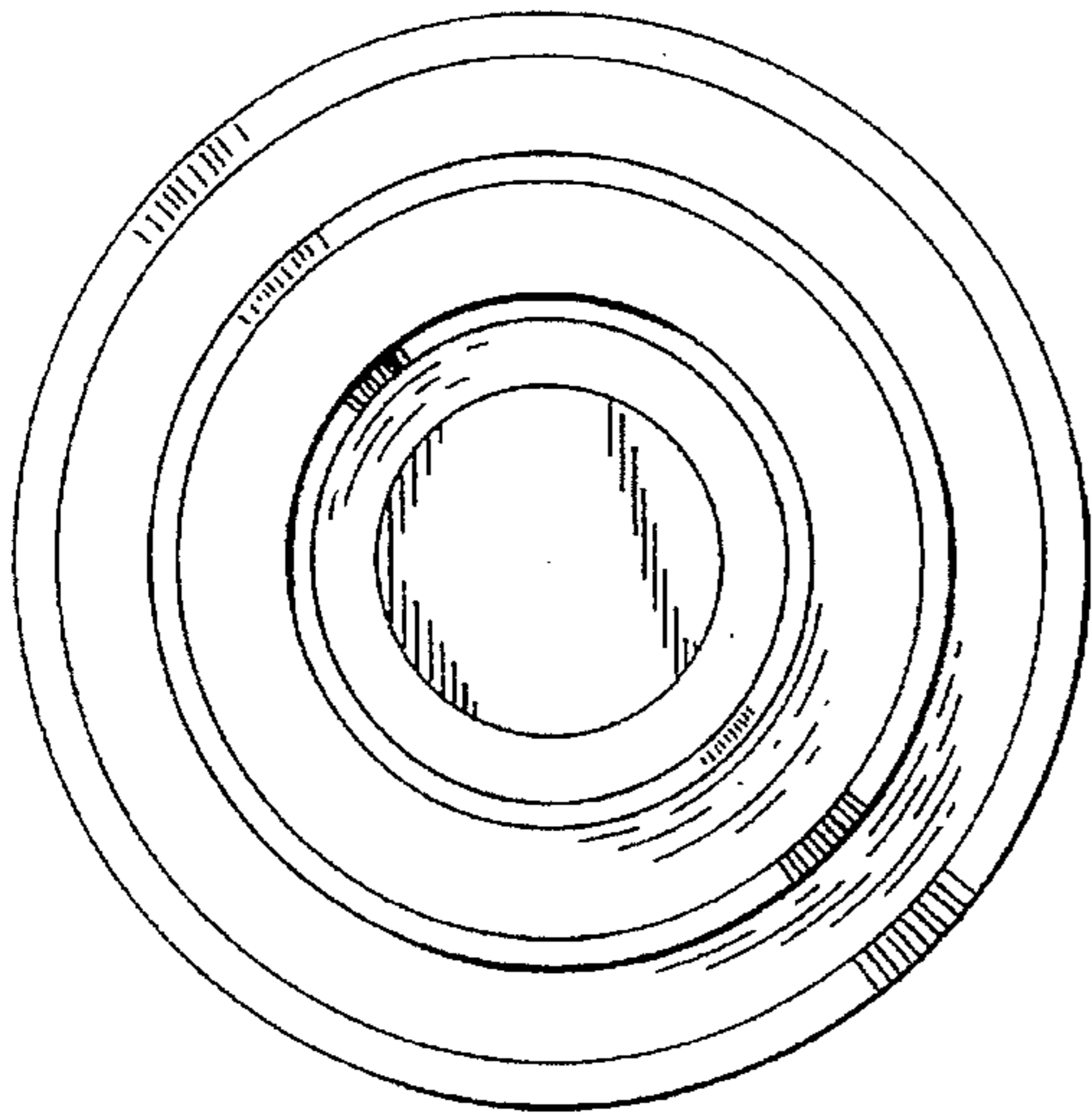

FIG. 2

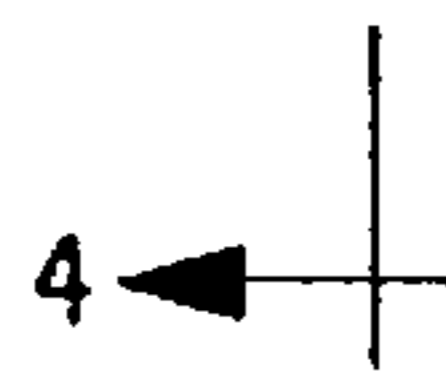
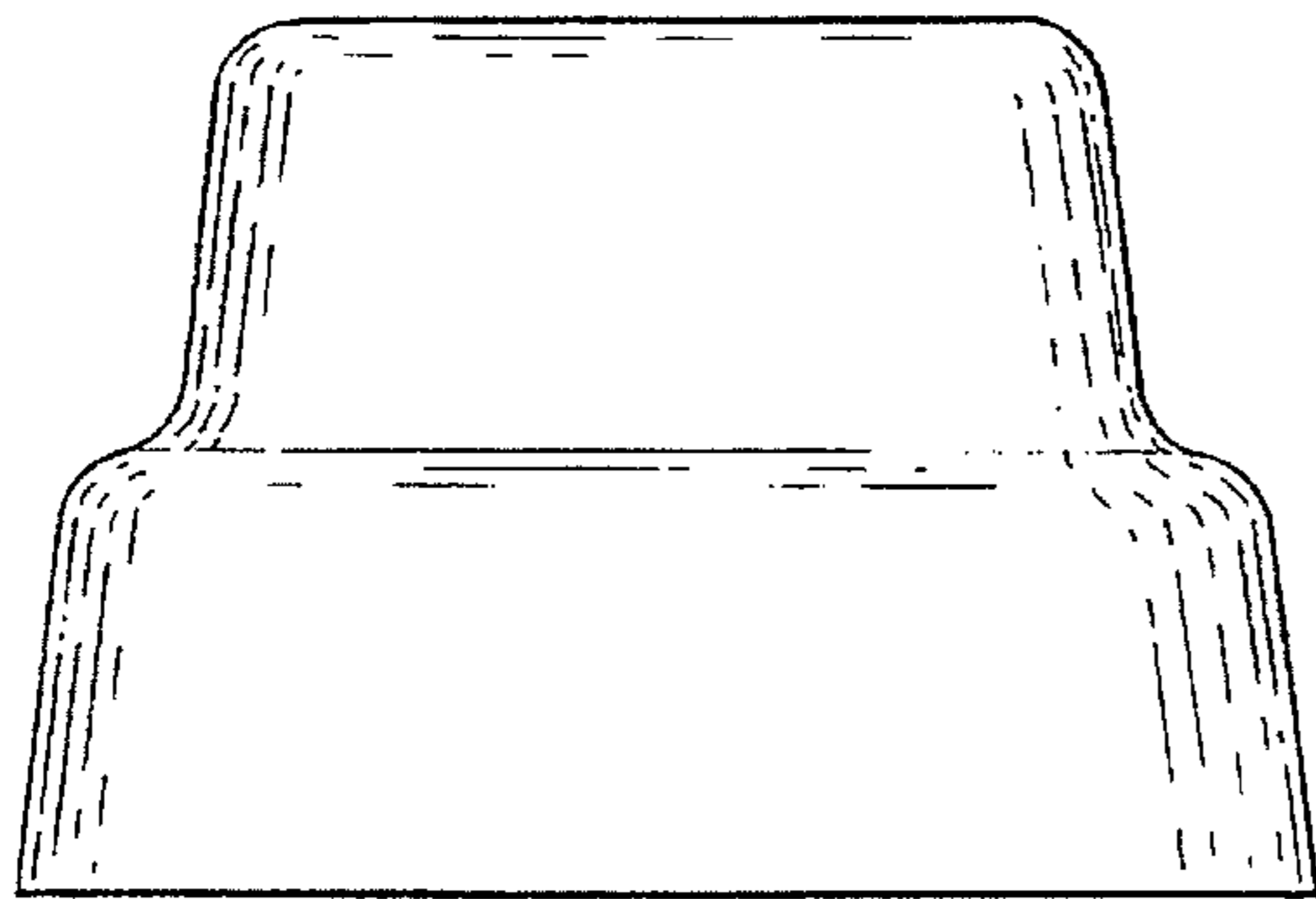
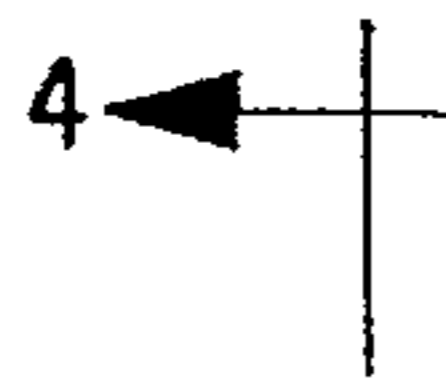

FIG. 1

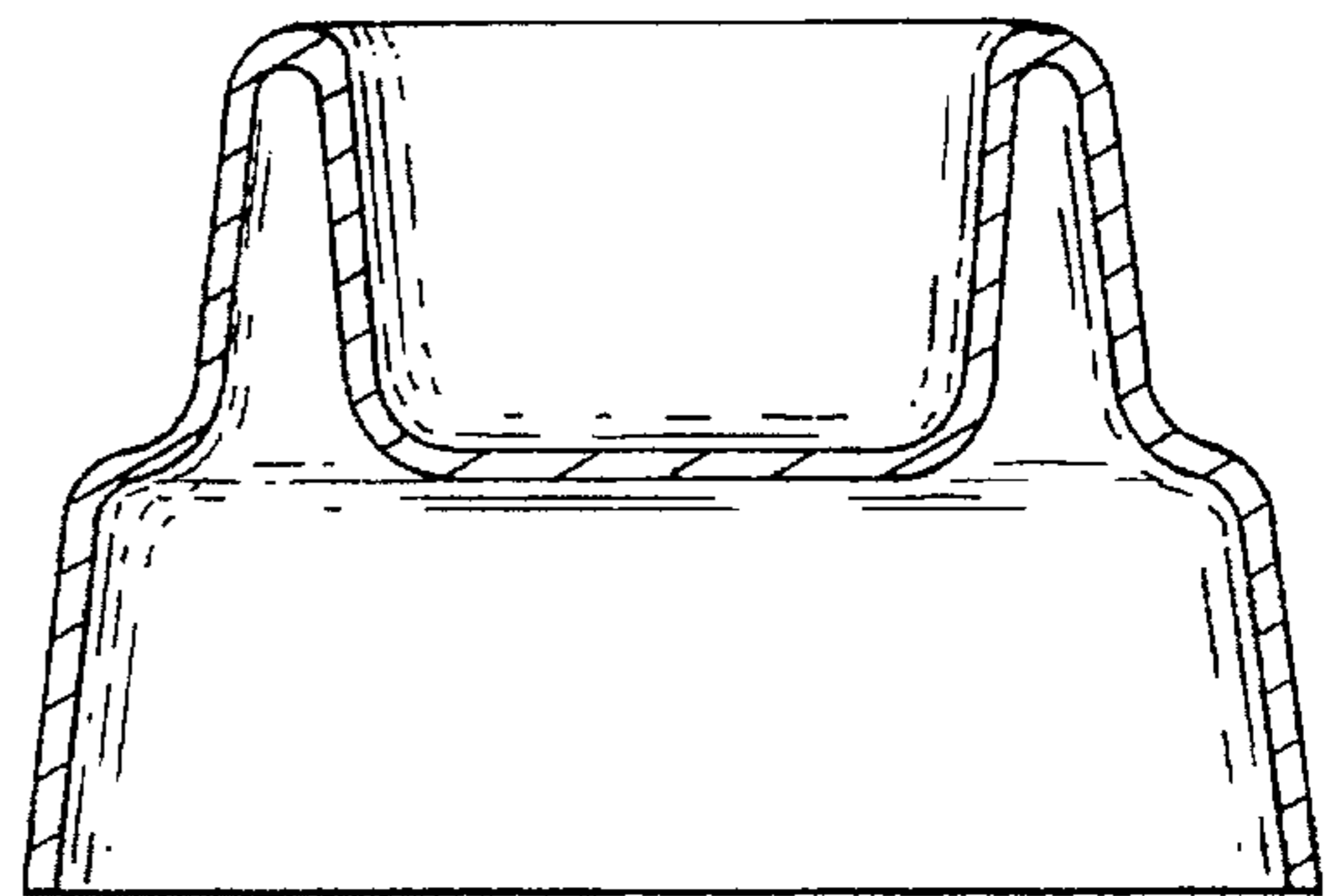

FIG. 4

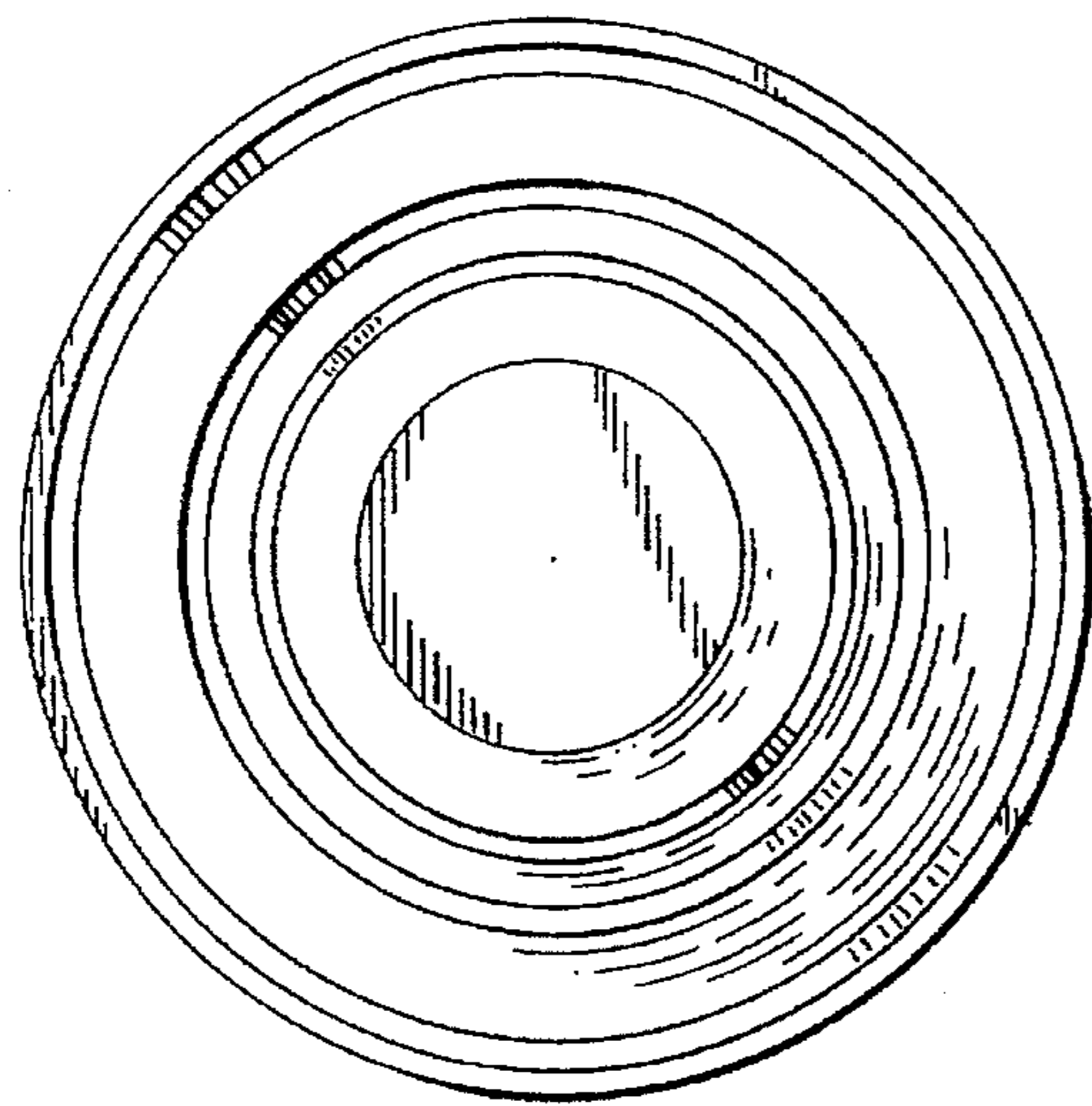

FIG. 3