



US00D379047S

# United States Patent [19]

Richard

[11] Patent Number: **Des. 379,047**

[45] Date of Patent: **\*\*May 6, 1997**

[54] **FOLDABLE BLEACHER SEAT WITH SECUREMENT STRAPS**

[76] Inventor: **Stephanie E. Richard**, 3689 N. Appell Dr., Port Clinton, Ohio 43452

[\*\*] Term: **14 Years**

[21] Appl. No.: **49,529**

[22] Filed: **Jan. 29, 1996**

[51] LOC (6) Cl. .... **06-09**

[52] U.S. Cl. .... **D6/601; D6/368**

[58] Field of Search ..... D6/595-597, 599-604, D6/611, 368; 5/636-638, 652, 653, 656, 654, 655.3, 417, 419, 420; 297/219.1, 229, 183.5, 452.21, 452.22, 452.23, 452.24, 452.26, 452.48, 452.61, 380, 350, 351

[56] **References Cited**

**U.S. PATENT DOCUMENTS**

D. 293,282 12/1987 Ashford ..... D6/368

D. 329,148	9/1992	Hwang et al.	.....	D6/368
D. 366,383	1/1996	Briegleb	.....	D6/601
4,824,171	4/1989	Hollingsworth	.....	D6/368 X
4,905,990	3/1990	DeSantis	.....	5/420 X
5,360,257	11/1994	Sciacca	.....	297/380

*Primary Examiner*—Janice E. Seeger

[57] **CLAIM**

The ornamental design for a foldable bleacher seat with securement straps, as shown and described.

**DESCRIPTION**

FIG. 1 is a front elevational view of the foldable bleacher seat with securement straps showing my new design; FIG. 2 is a rear elevational view thereof; FIG. 3 is a right view thereof; FIG. 4 is a left view thereof; FIG. 5 is a bottom plan view thereof; FIG. 6 is a top plan view thereof; and, FIG. 7 is an isometric view thereof.

**1 Claim, 4 Drawing Sheets**

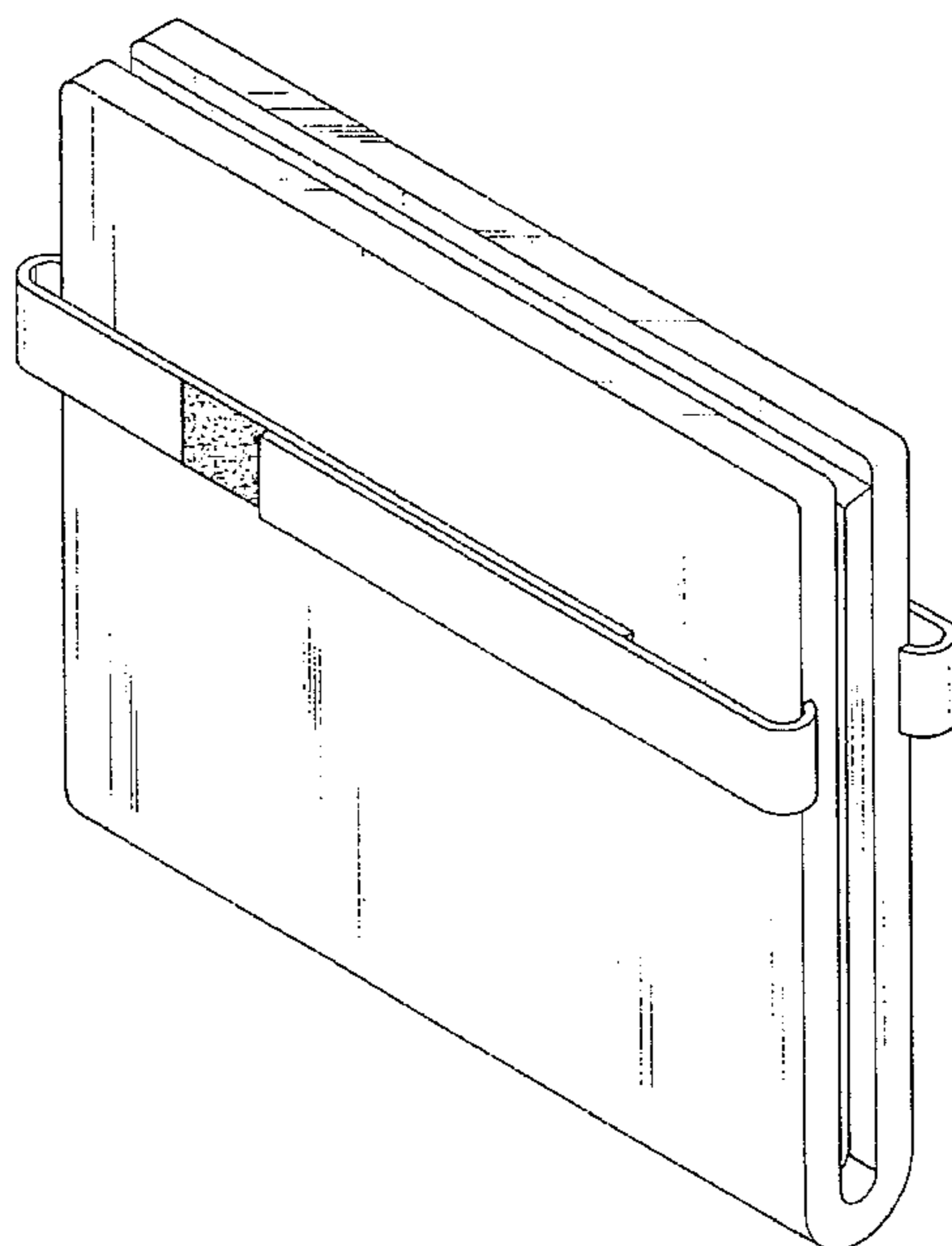
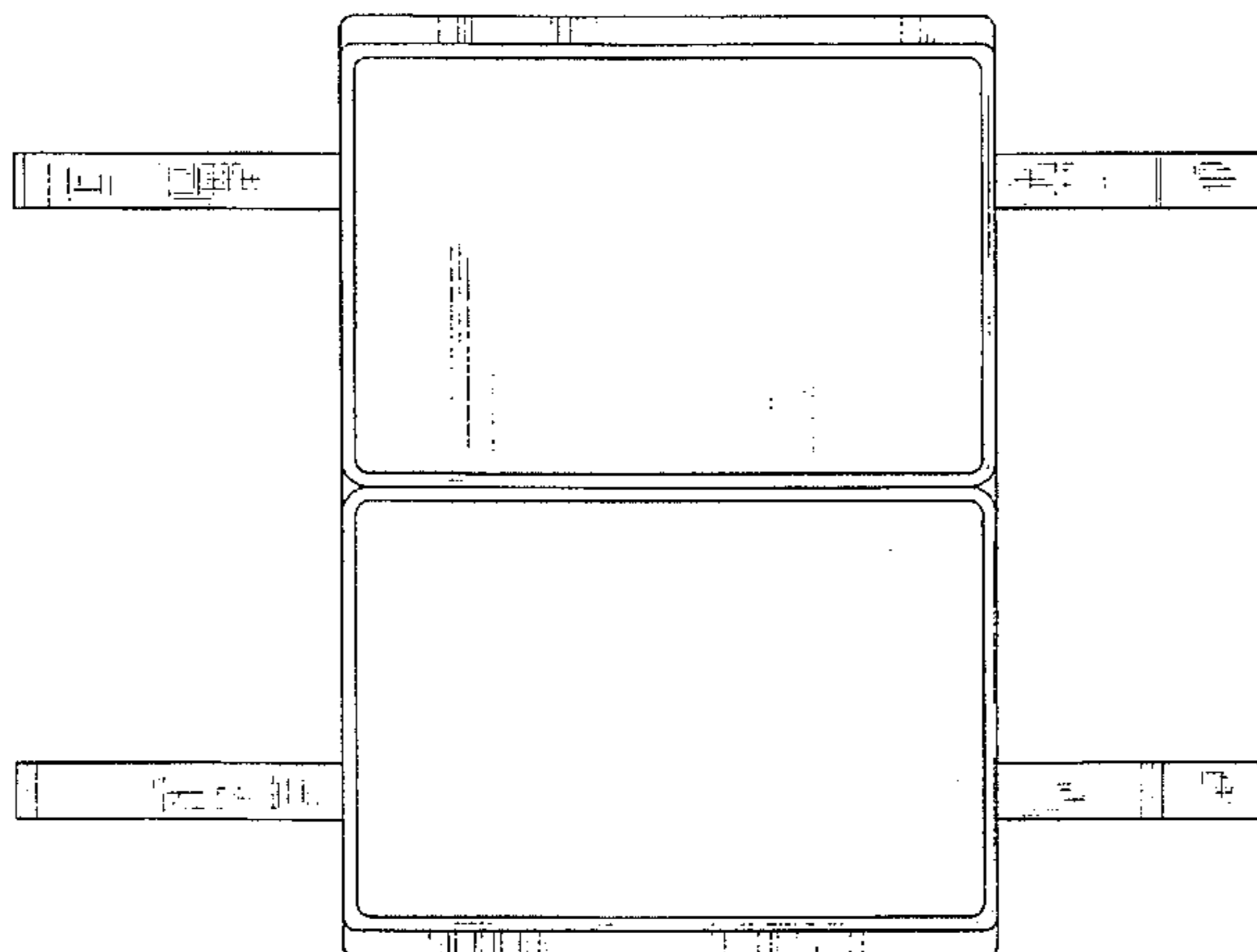

FIG. 1

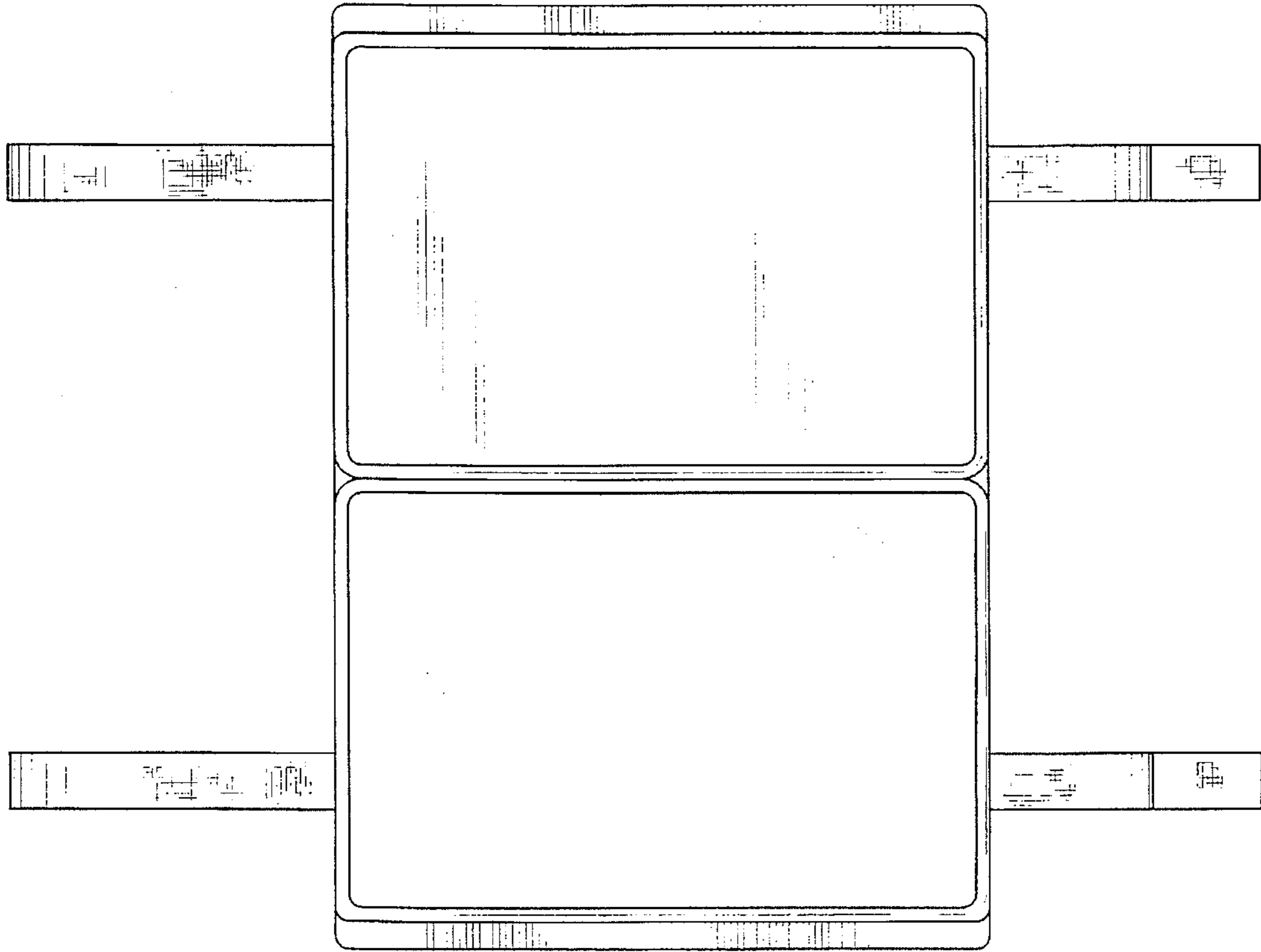

FIG. 2

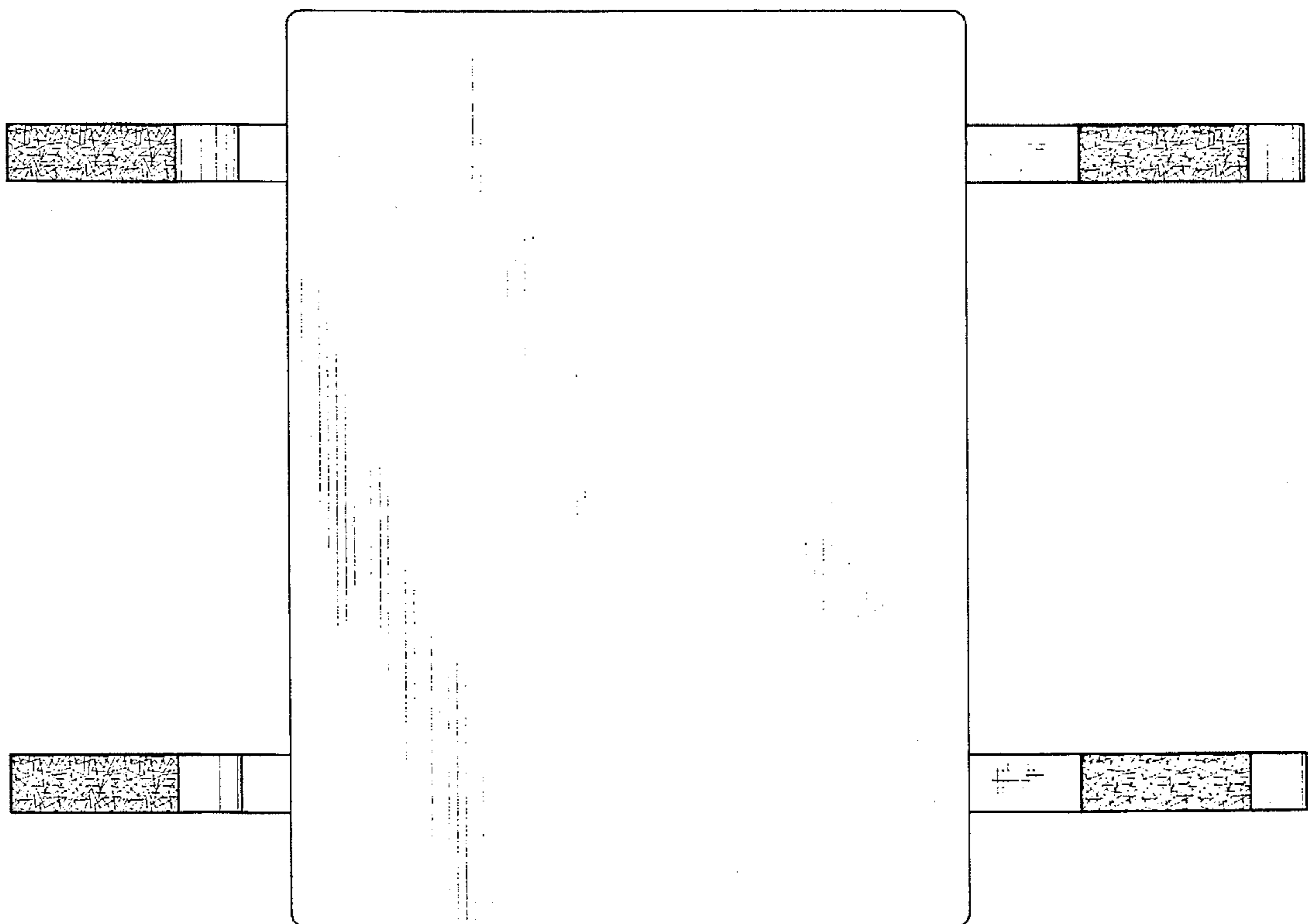

FIG. 3

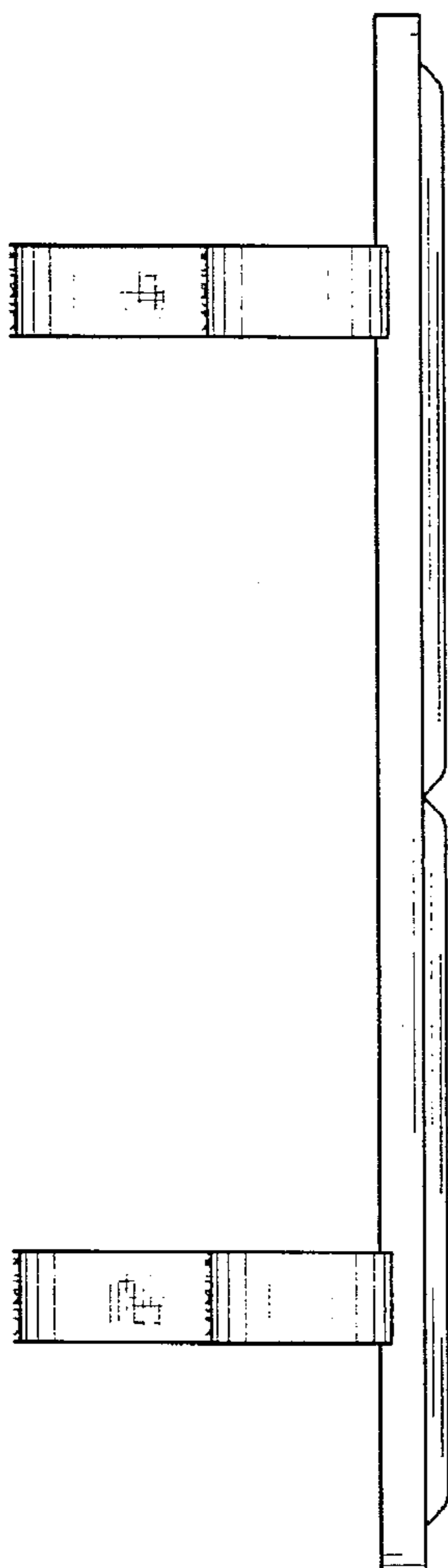

FIG. 4

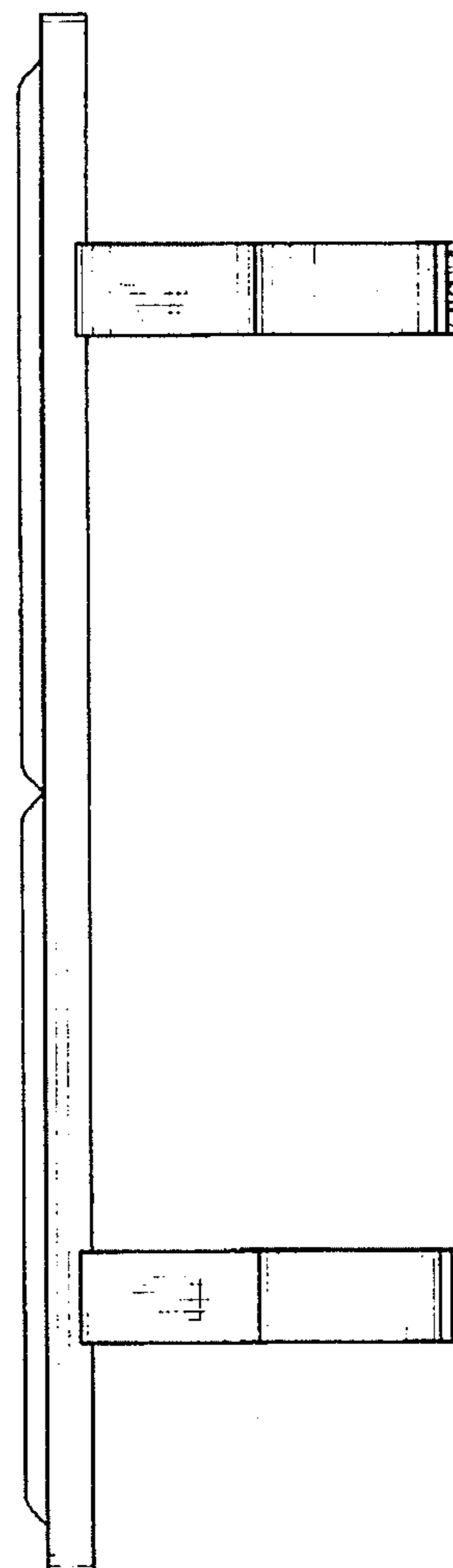

FIG. 5

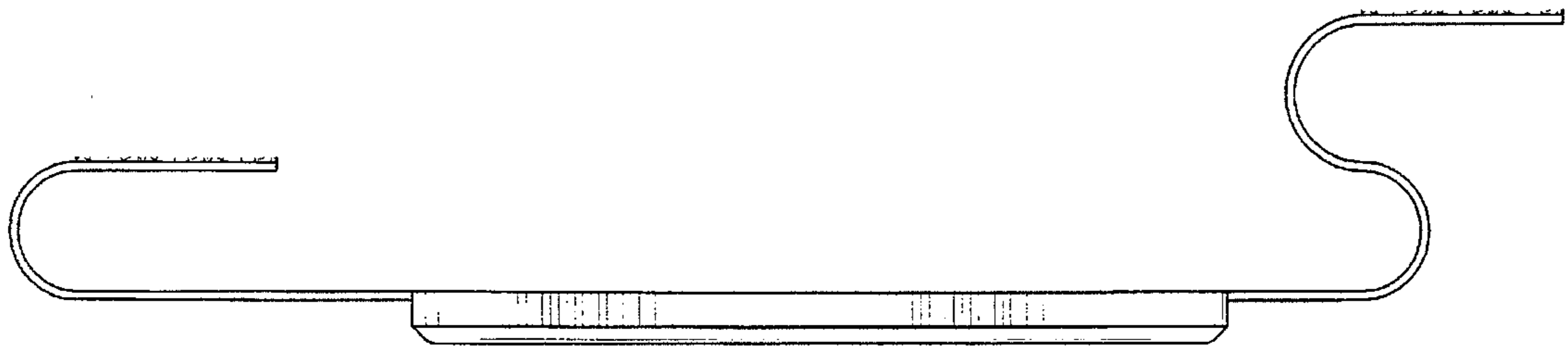

FIG. 6

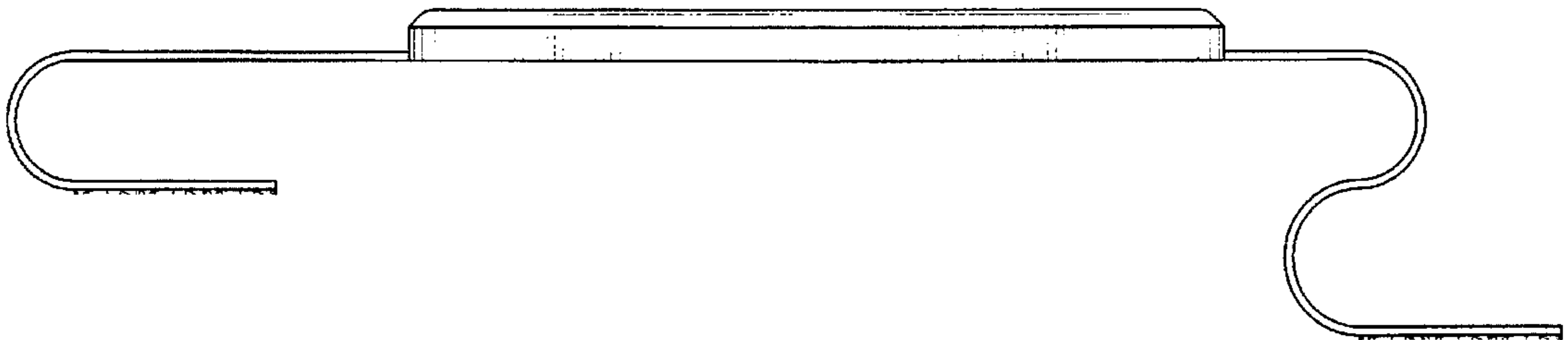

FIG. 7

