



US00D378986S

United States Patent [19]
Darula

[11] **Patent Number:** **Des. 378,986**

[45] **Date of Patent:** ****Apr. 29, 1997**

[54] **FENCE BRACKET**

[76] **Inventor:** **Calvin Darula, 36 Angelus Dr.,
Greenwich, Conn. 06831**

[**] **Term:** **14 Years**

[21] **Appl. No.:** **51,833**

[22] **Filed:** **Mar. 19, 1996**

[52] **U.S. Cl.** **D8/354**

[58] **Field of Search** **D8/349, 354; D25/38-39,
D25/43; 248/300, 27.1. 200**

[56] **References Cited**

U.S. PATENT DOCUMENTS

D. 267,308	12/1982	France	D8/354	X
D. 364,796	12/1995	Yates	D8/354	
2,686,848	8/1954	Wicknick	248/300	X

Primary Examiner—Holly H. Baynham

[57] **CLAIM**

The ornamental design for a fence bracket, as shown and described.

DESCRIPTION

FIG. 1 is a front elevational view of the fence bracket showing my new design;
 FIG. 2 is a rear elevational view thereof;
 FIG. 3 is a right view thereof;
 FIG. 4 is a left view thereof;
 FIG. 5 is a top plan view thereof;
 FIG. 6 is a bottom plan view thereof; and,
 FIG. 7 is an isometric view thereof illustrating its function with wooden fencing components.
 The broken line showing of fragmented wooden fencing components is for illustrative purposes only and forms no part of the claimed design.

1 Claim, 3 Drawing Sheets

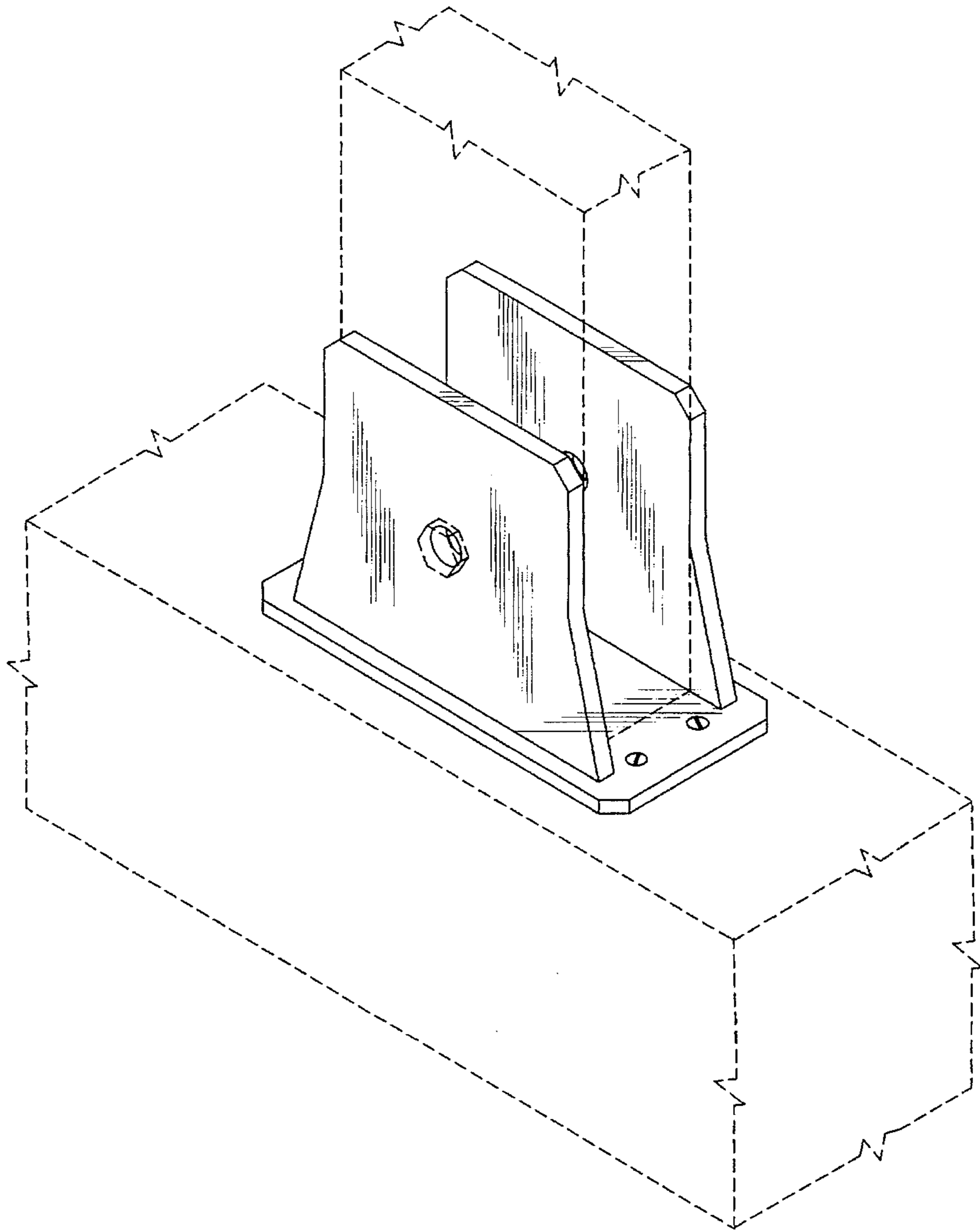

FIG. 1

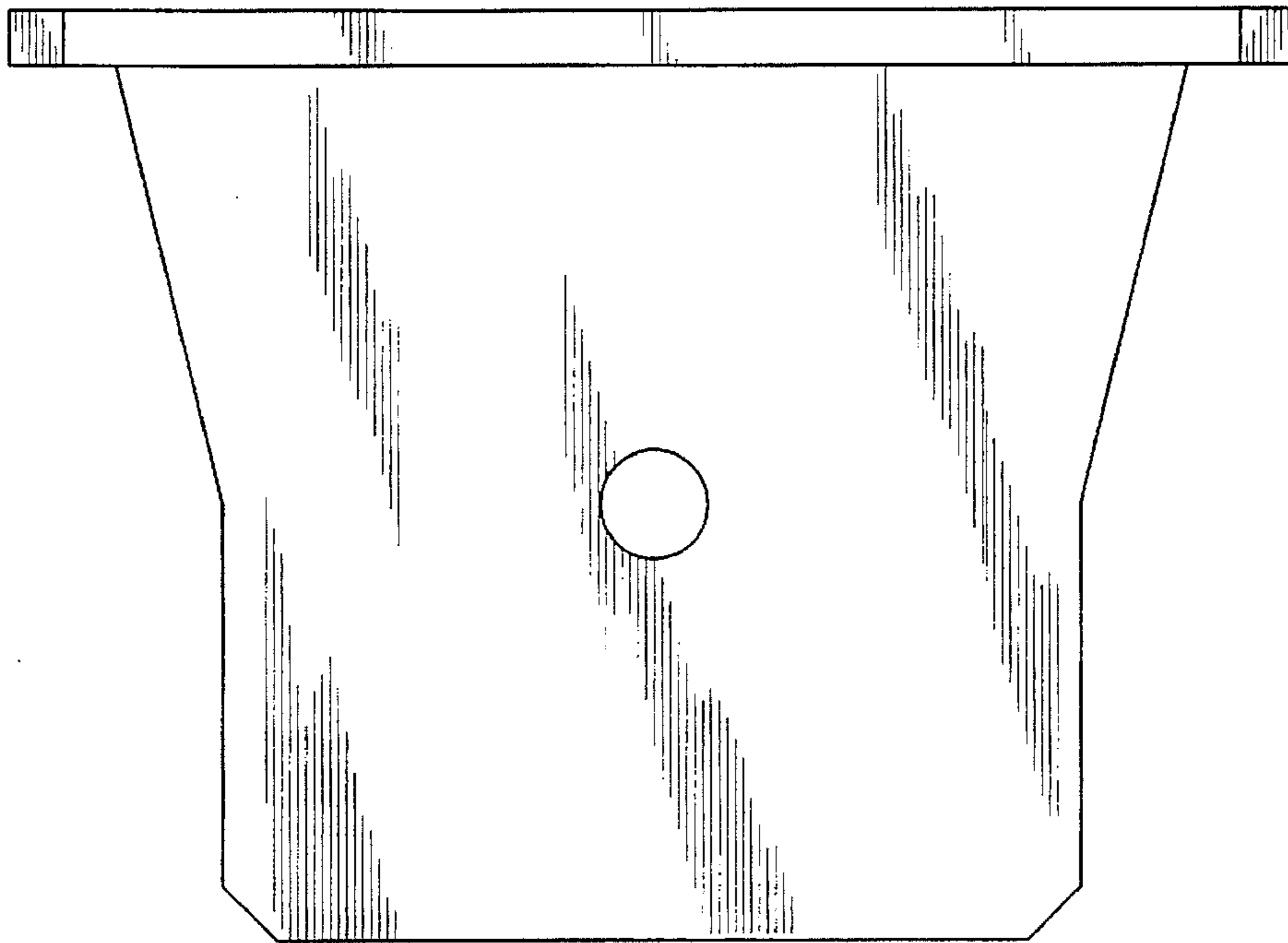

FIG. 2

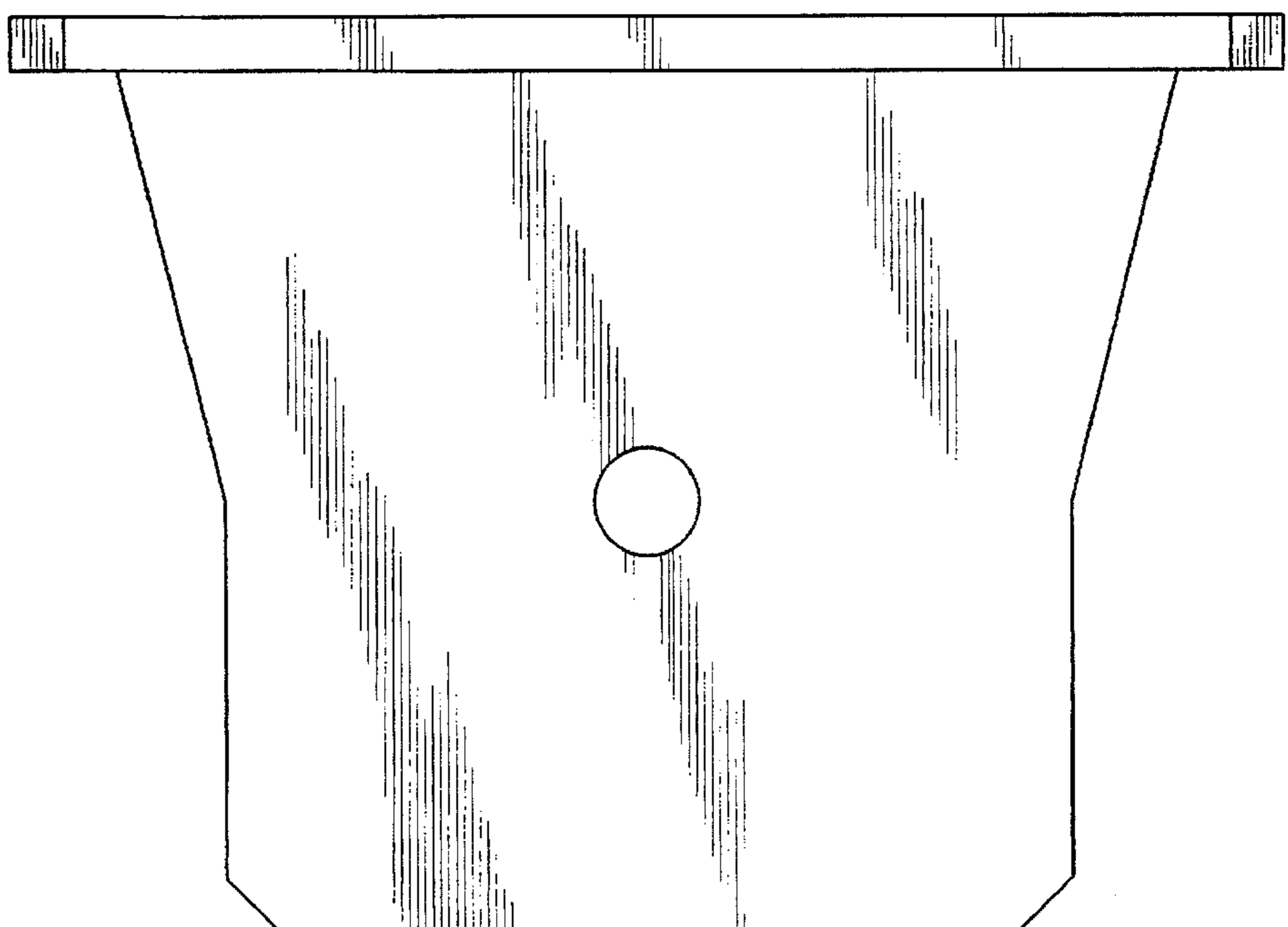

FIG. 3

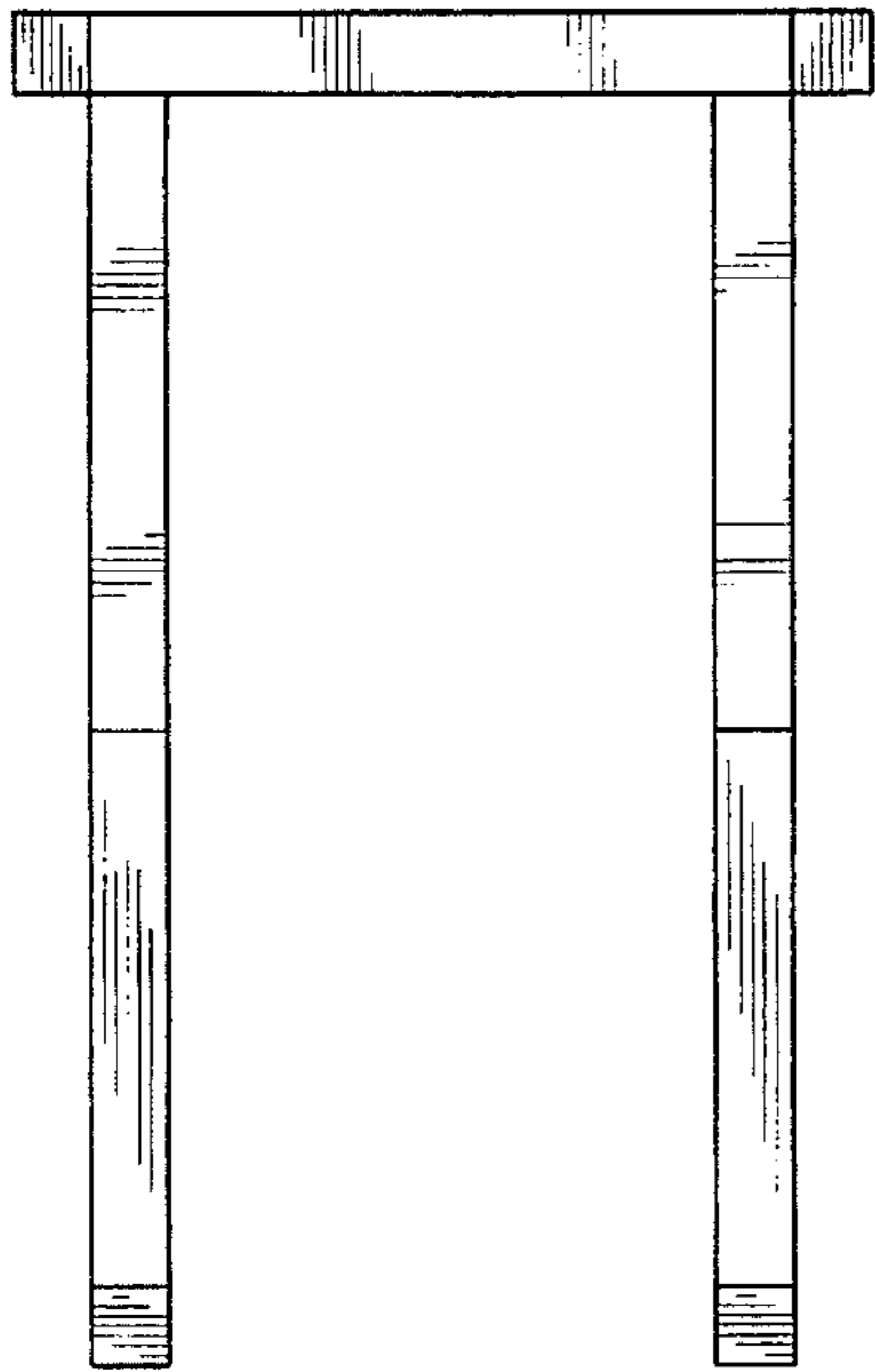

FIG. 4

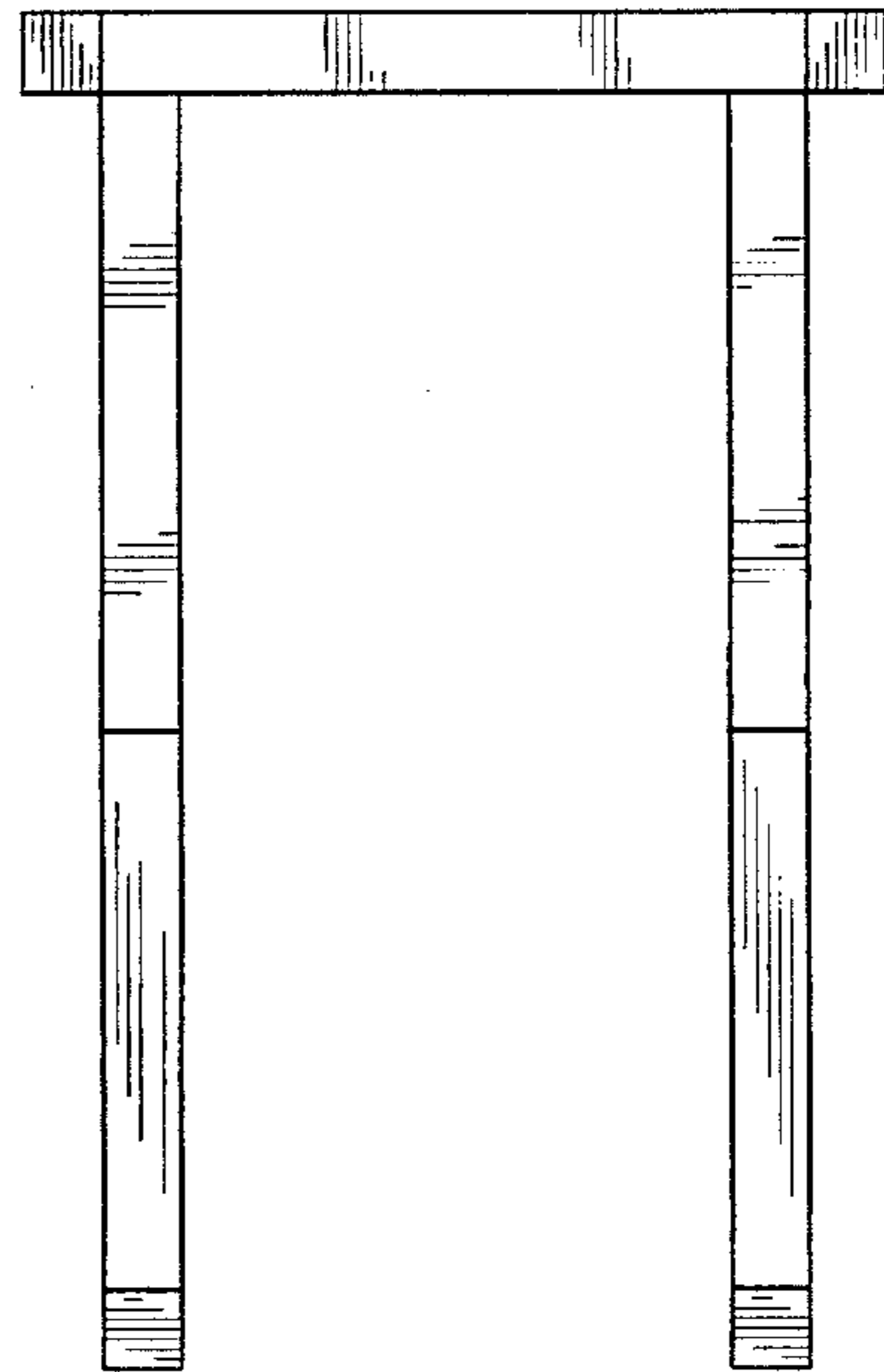

FIG. 5

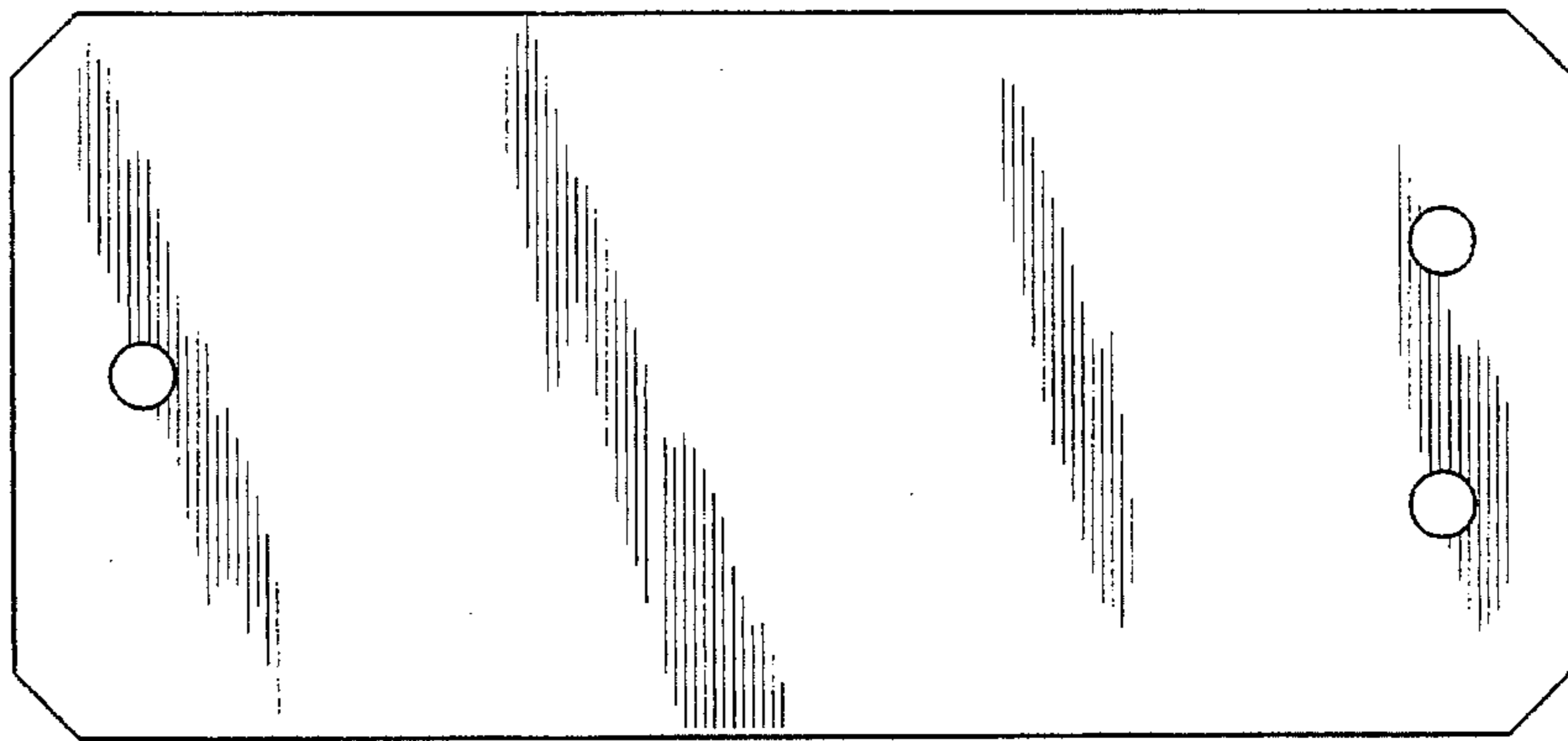

FIG. 6

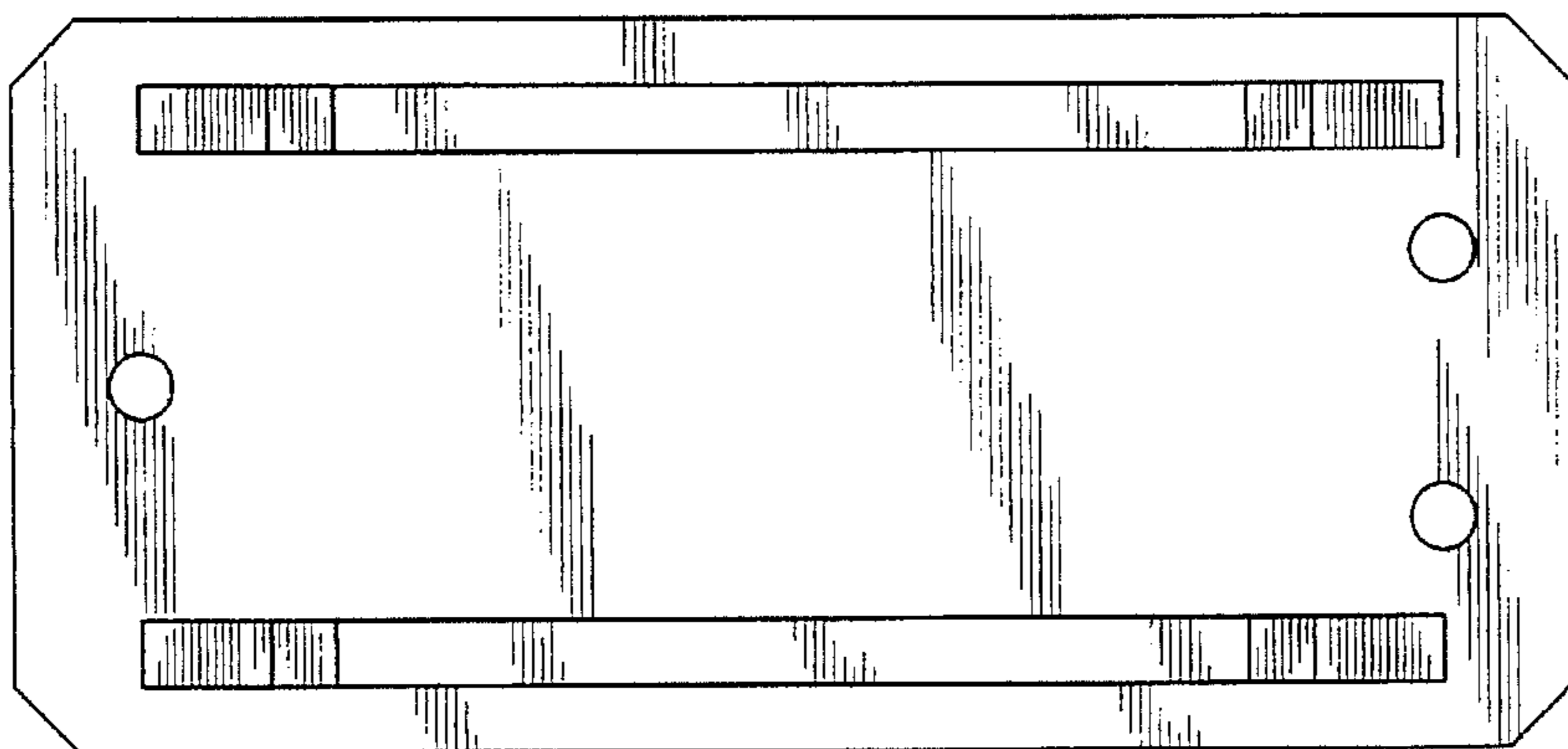

FIG. 7

