



US00D378952S

United States Patent [19]

Stava

[11] Patent Number: **Des. 378,952**

[45] Date of Patent: ****Apr. 29, 1997**

[54] DISGUISED WEAPON HOLDER

[76] Inventor: **Scott H. Stava**, 340 W. Fallbrook, No. 104, Fresno, Calif. 93711

[**] Term: **14 Years**

[21] Appl. No.: **40,699**

[22] Filed: **Jun. 23, 1995**

[51] Int. Cl.⁶

[52] U.S. Cl. **D3/222**

[58] Field of Search D3/222, 223, 230, D3/232, 246, 218, 224, 226; 224/191, 192, 193, 198, 238, 240, 243, 911, 912, 244, 239, 245; 206/317

[56] References Cited

U.S. PATENT DOCUMENTS

D. 266,971	11/1982	Katz et al.	D3/246 X
D. 334,285	3/1993	Wilson	D3/218
D. 343,291	1/1994	Langford	D3/218
4,750,655	6/1988	Barry	224/243
5,234,145	8/1993	Padin	224/192 X

Primary Examiner—Doris V. Coles
Assistant Examiner—Catherine R. Oliver
Attorney, Agent, or Firm—Mark D. Miller

[57] CLAIM

The ornamental design for a disguised weapon holder, as shown and described.

DESCRIPTION

FIG. 1 is a perspective view of disguised weapon holder showing my new design;
FIG. 2 is a rear perspective view thereof;
FIG. 3 is a front elevational view thereof;
FIG. 4 is a rear elevational view thereof;
FIG. 5 is a top plan view thereof;
FIG. 6 is a bottom view thereof;
FIG. 7 is a left side elevational view thereof;
FIG. 8 is a right side elevational view thereof; and,
FIG. 9 is a perspective view, shown in an open position with the lock removed. The broken line showing of a gun and star in FIG. 9, and a belt in FIGS. 1-8 being for illustrative purposes only and forming no part of the claimed design.

1 Claim, 5 Drawing Sheets

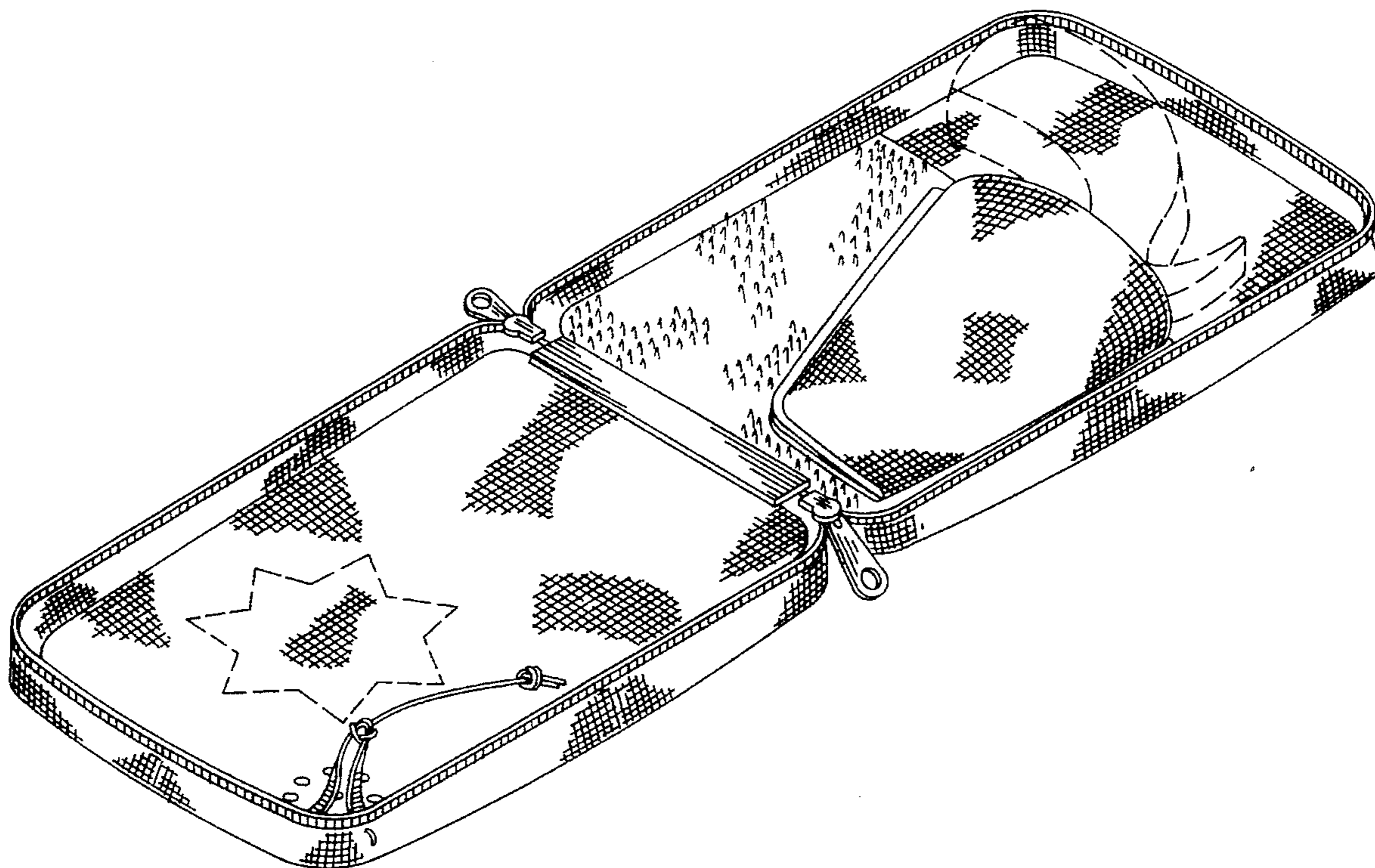

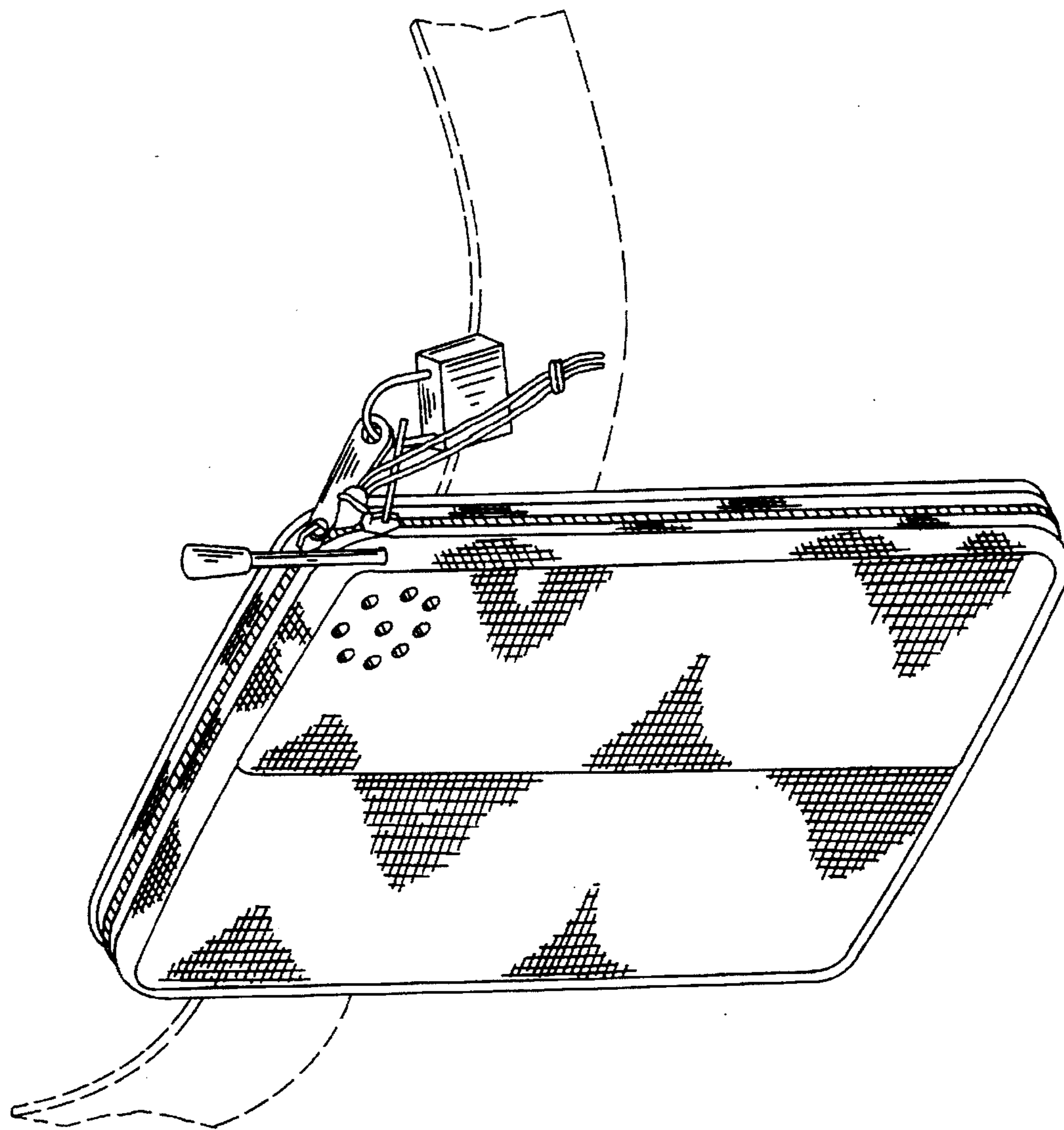

FIG. 1

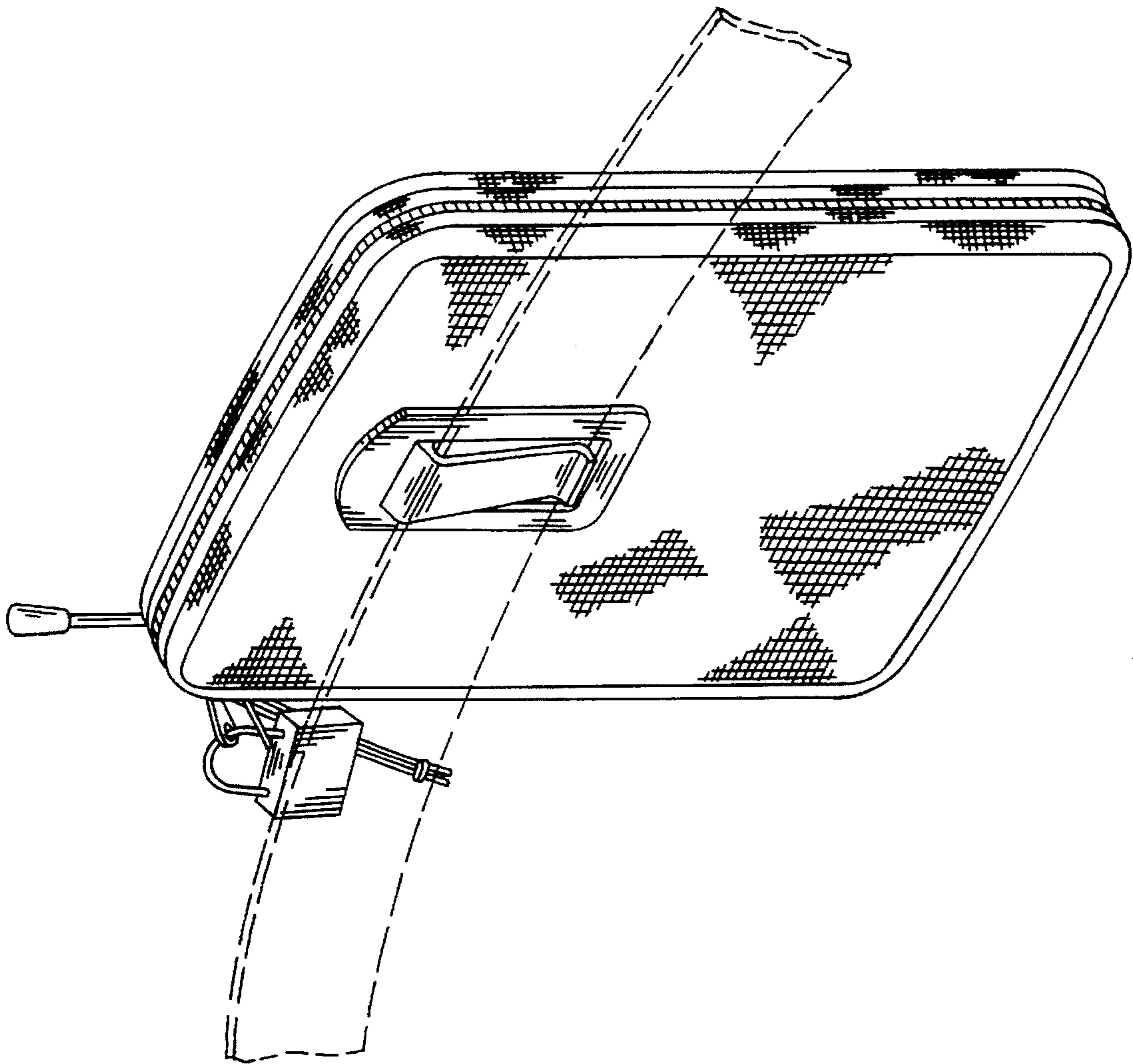

FIG. 2

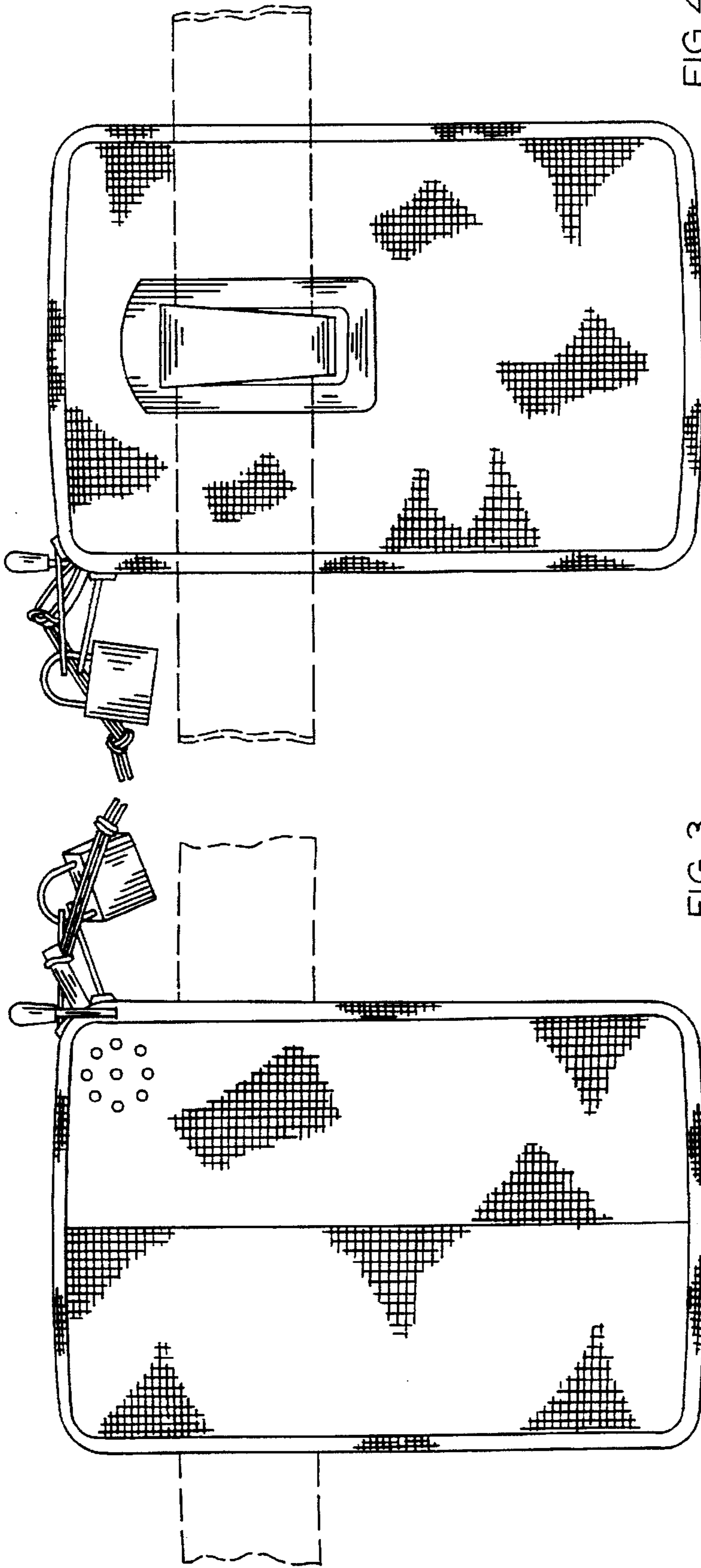

FIG. 3

FIG. 4

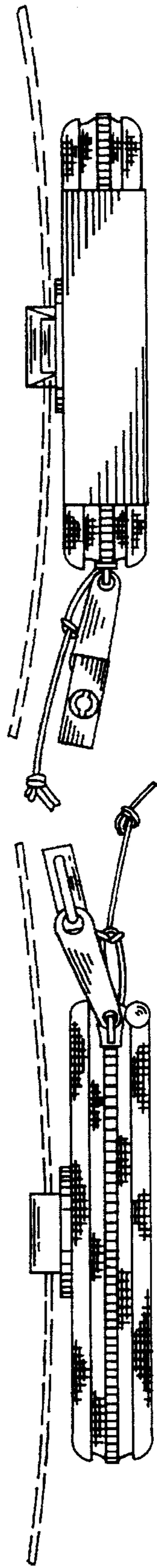

FIG. 5

FIG. 6

FIG. 8

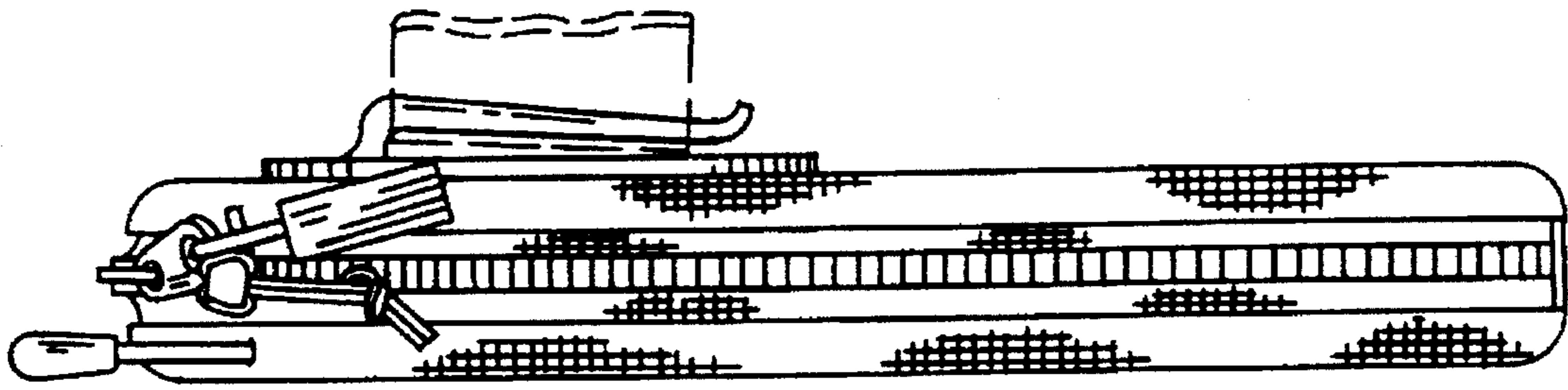
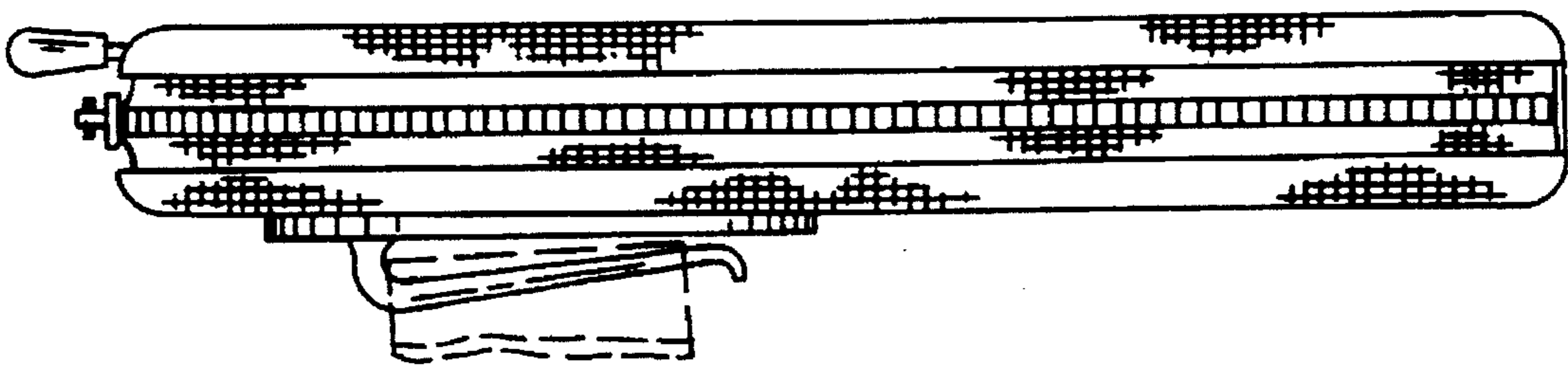

FIG. 7



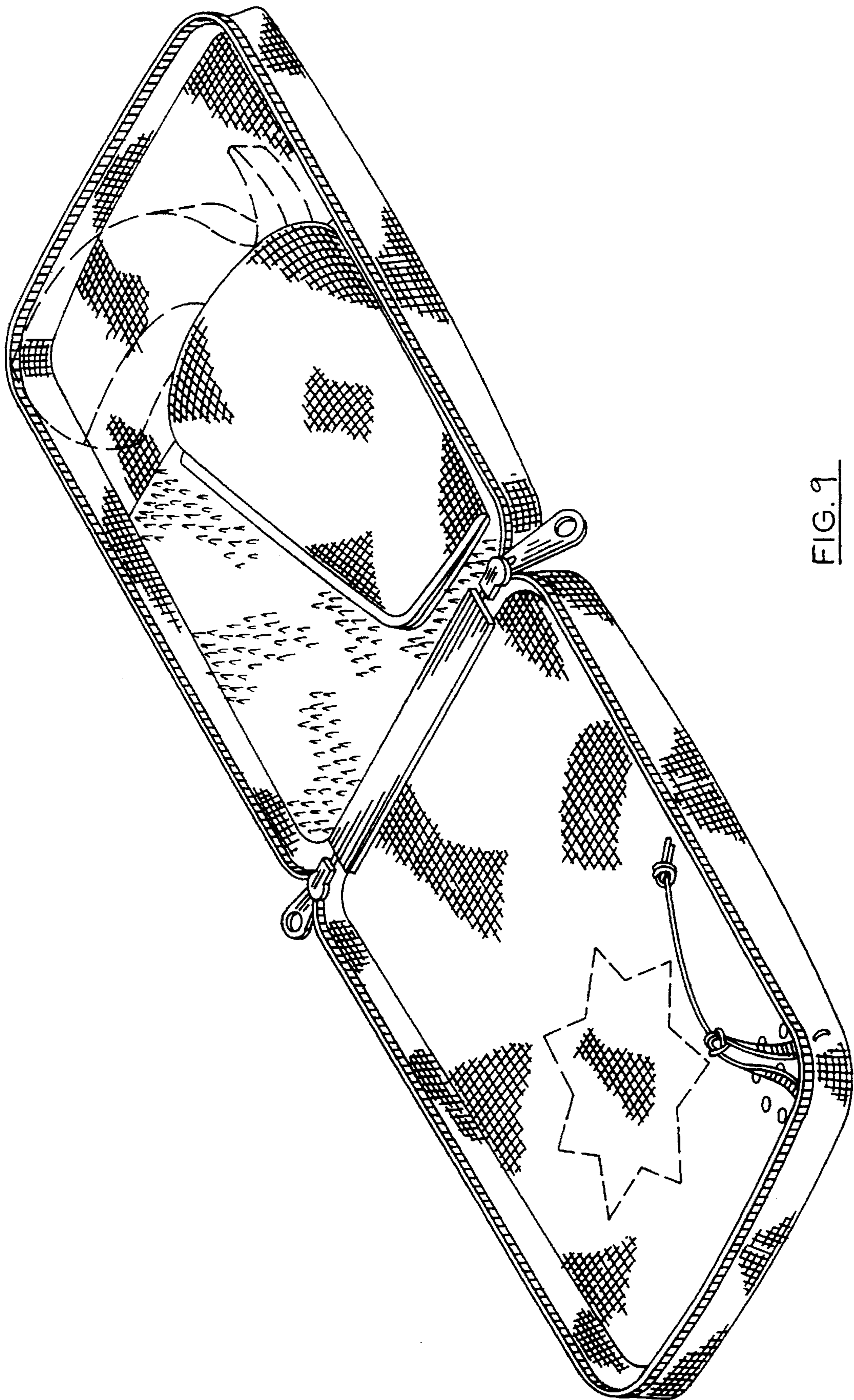

FIG. 9