



US00D378917S

United States Patent [19] Ohayon

[11] Patent Number: **Des. 378,917**
[45] Date of Patent: ****Apr. 22, 1997**

[54] **APPARATUS FOR PROTECTION OF COIN-OPERATED TELEPHONES**

[75] Inventor: **David Ohayon**, Hewitt, N.J.
[73] Assignee: **Renault Metal Products, Ltd.**, Middle Village, N.Y.
[**] Term: **14 Years**
[21] Appl. No.: **33,291**
[22] Filed: **Jan. 9, 1995**

4,645,876	2/1987	Albertson .	
4,946,095	8/1990	Anello et al. .	
4,974,257	11/1990	Ibanez et al. .	
5,018,193	5/1991	DeArkland .	
5,054,056	10/1991	Blythe .	
5,131,035	7/1992	Ohayon .	
5,134,654	7/1992	McGough .	
5,148,476	9/1992	Zausner .	
5,155,765	10/1992	McGough .	
5,381,469	1/1995	Zausner	379/440 X
5,402,476	3/1995	Ohayon	379/440 X

Related U.S. Application Data

[63] Continuation-in-part of Ser. No. 99,932, Jul. 29, 1993, Pat. No. 5,402,476.
[52] U.S. Cl. **D14/146; D14/250**
[58] Field of Search 379/143, 145, 379/437, 440, 451; D14/140, 240, 146, 150

References Cited

U.S. PATENT DOCUMENTS

D. 197,974	4/1964	Dreyfuss	D14/146
D. 226,926	5/1973	Glass	D14/240
D. 227,783	7/1973	Janda et al.	D14/146
D. 315,908	4/1991	Ward	D14/250
2,716,882	9/1955	Gill et al. .	
3,213,210	10/1965	Samples .	
3,297,123	1/1967	Hutchins .	
3,335,945	8/1967	Hutchins .	
3,391,256	7/1968	Nawman .	
3,833,104	9/1974	Blum .	
3,868,483	2/1975	Trimmer et al. .	
3,910,393	10/1975	de Crepy .	
4,159,054	6/1979	Yoshida .	
4,267,411	5/1981	Raines .	
4,406,358	9/1983	Zahradnik .	

OTHER PUBLICATIONS

Linda M. Barrett, "Renault Secures Payphones," Payphone Exchange, Sep. 1989, p. 9.

Primary Examiner—Jeffrey Asch
Attorney, Agent, or Firm—Peter G. Dilworth; Rocco S. Barrese; Joseph J. Catanzaro

[57] CLAIM

The ornamental design for an apparatus for protection of coin operated telephones, as shown and described.

DESCRIPTION

FIG. 1 is a top front perspective view from the left side, of an apparatus for protection of coin operated telephones, illustrating my new design, the telephone being shown in phantom for environmental purposes;
FIG. 2 is a perspective view thereof with parts separated for ease of illustration;
FIG. 3 is a top plan view thereof;
FIG. 4 is a right side elevational view thereof;
FIG. 5 is a rear elevational view thereof; and,
FIG. 6 is a bottom plan view thereof.
The broken line showings of FIGS. 1-3 are for illustrative purposes only and form no part of the claimed design.

1 Claim, 3 Drawing Sheets

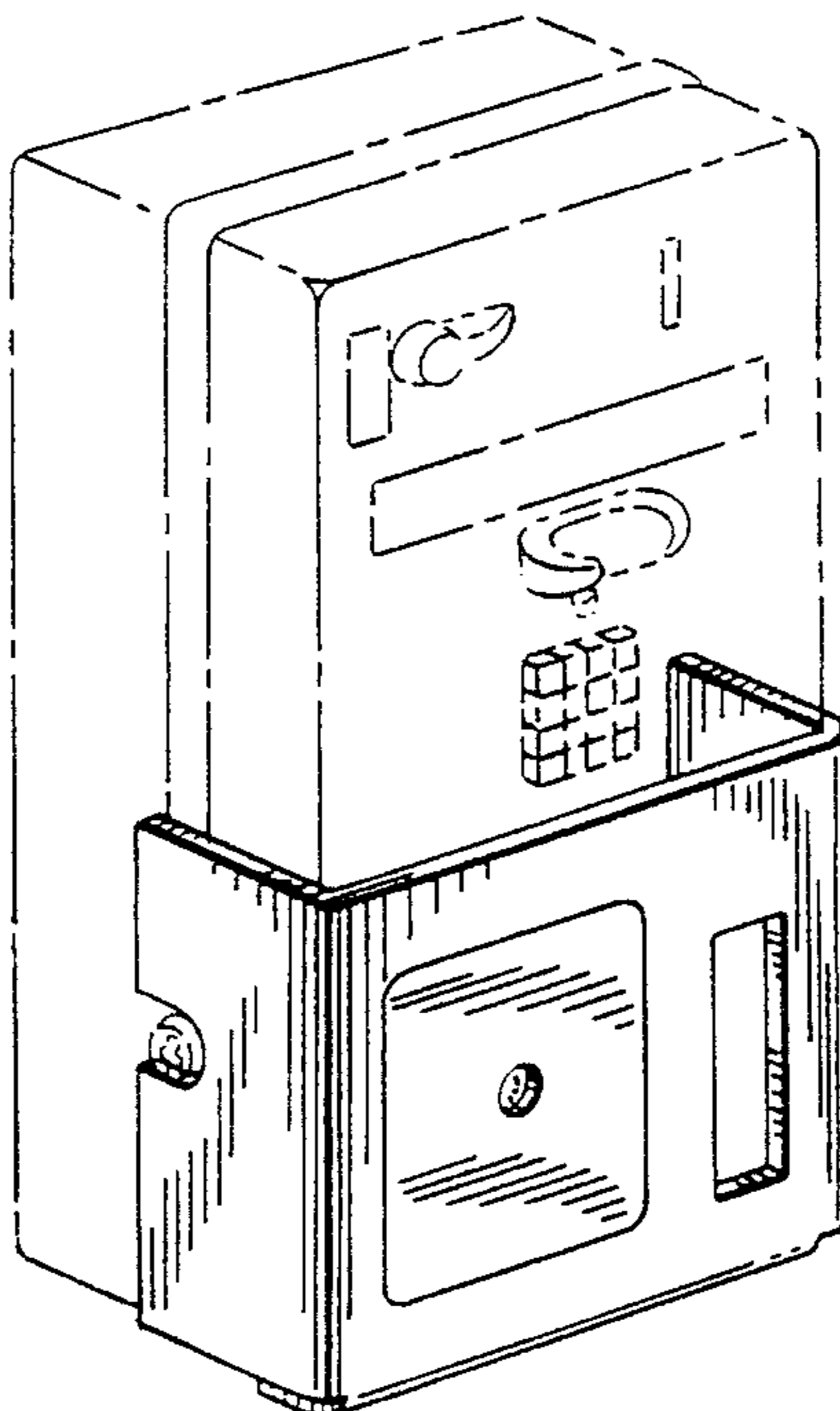

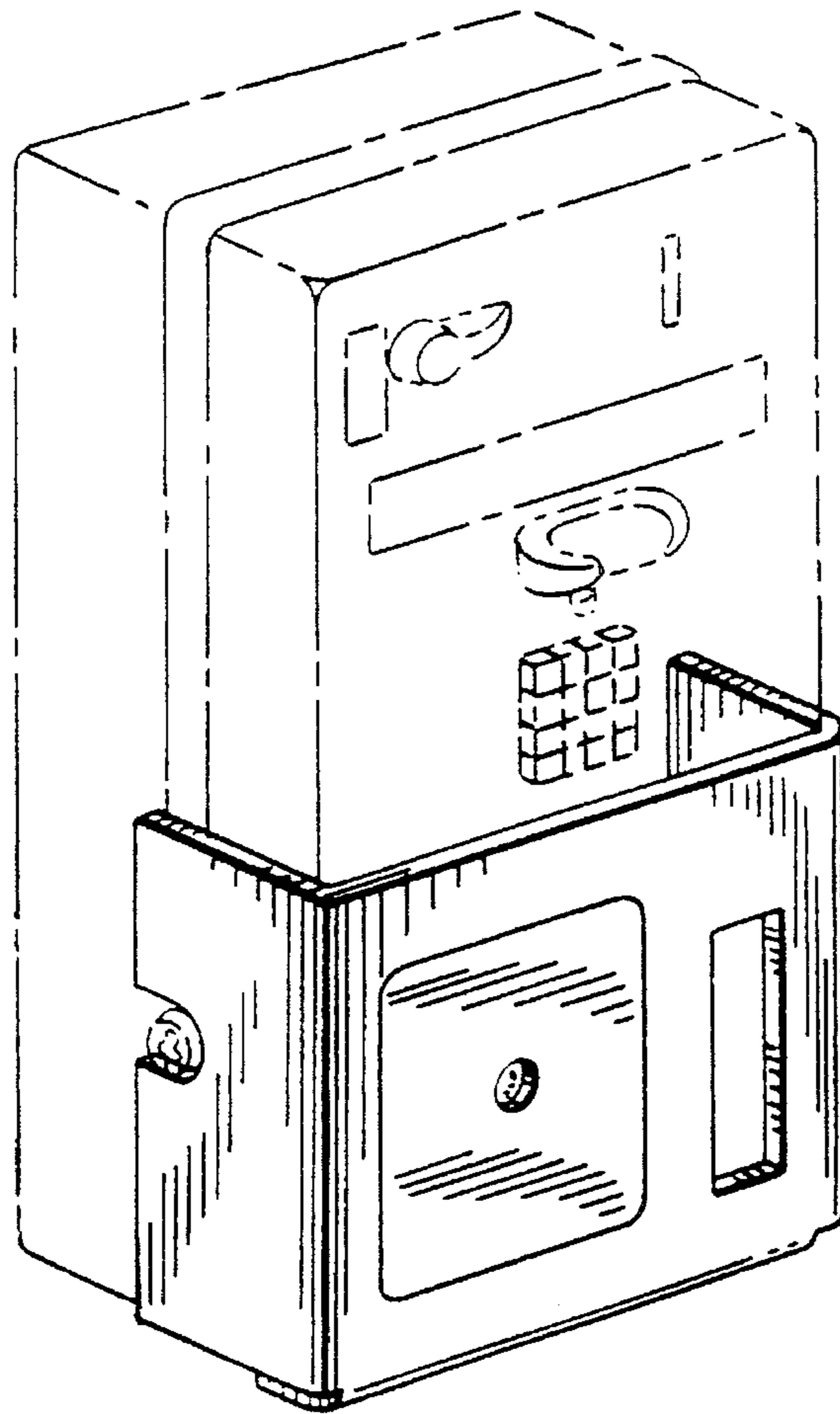

FIG. 1

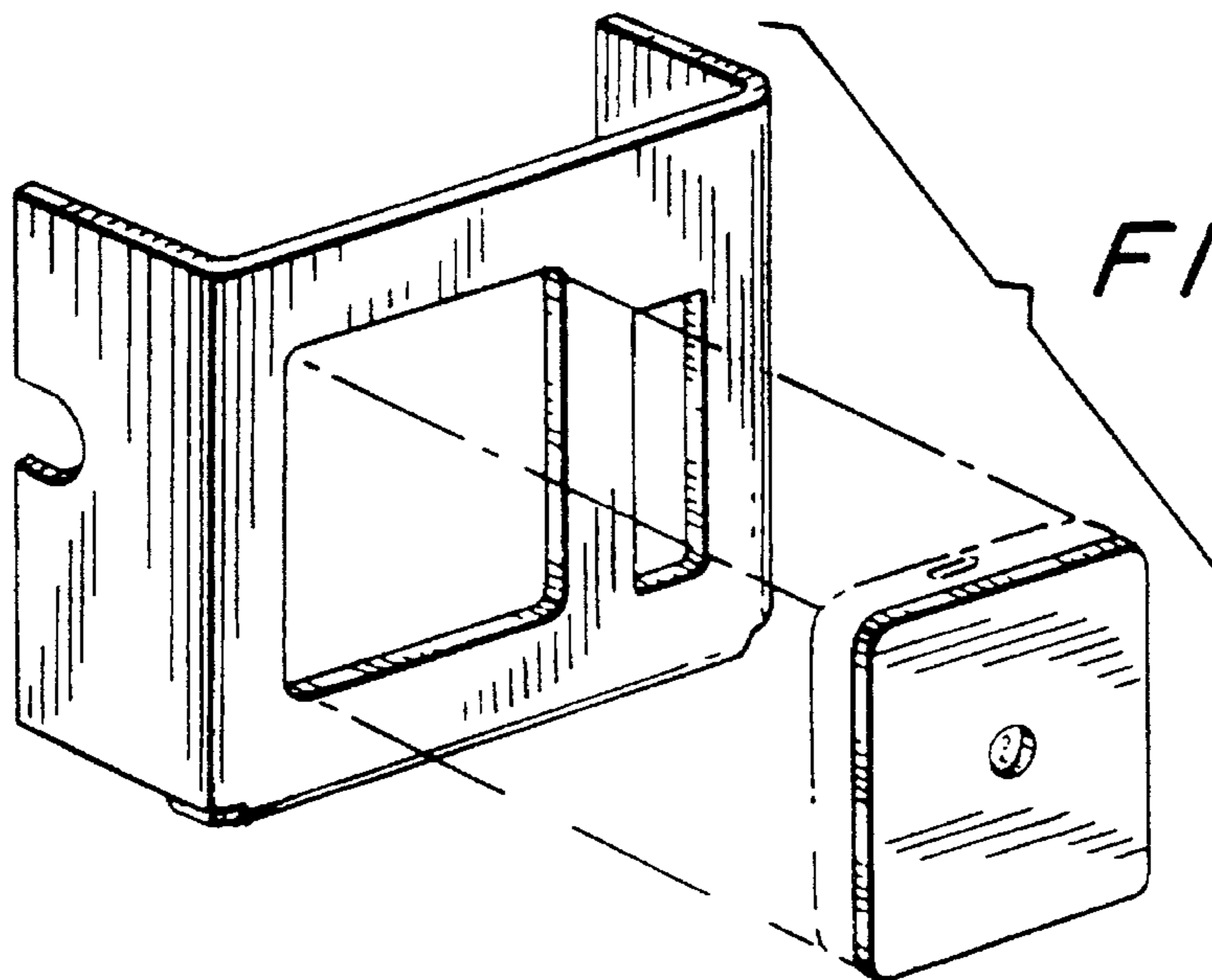

FIG. 2

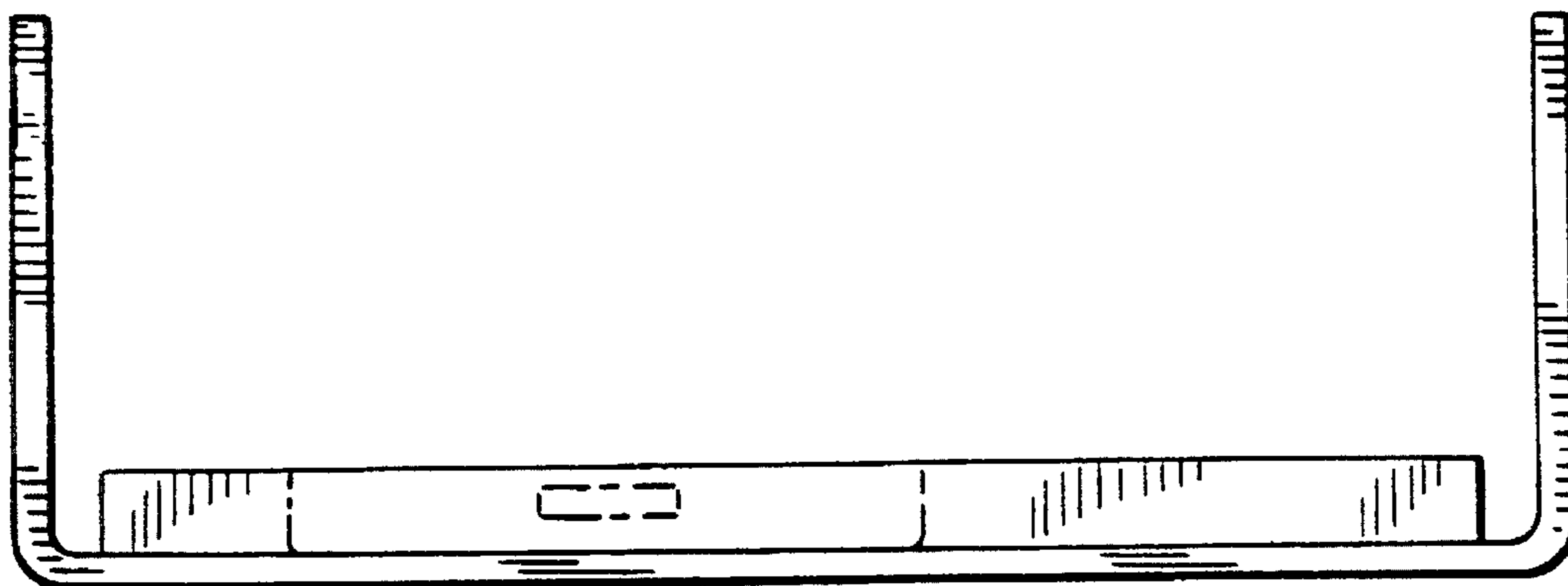

FIG. 3

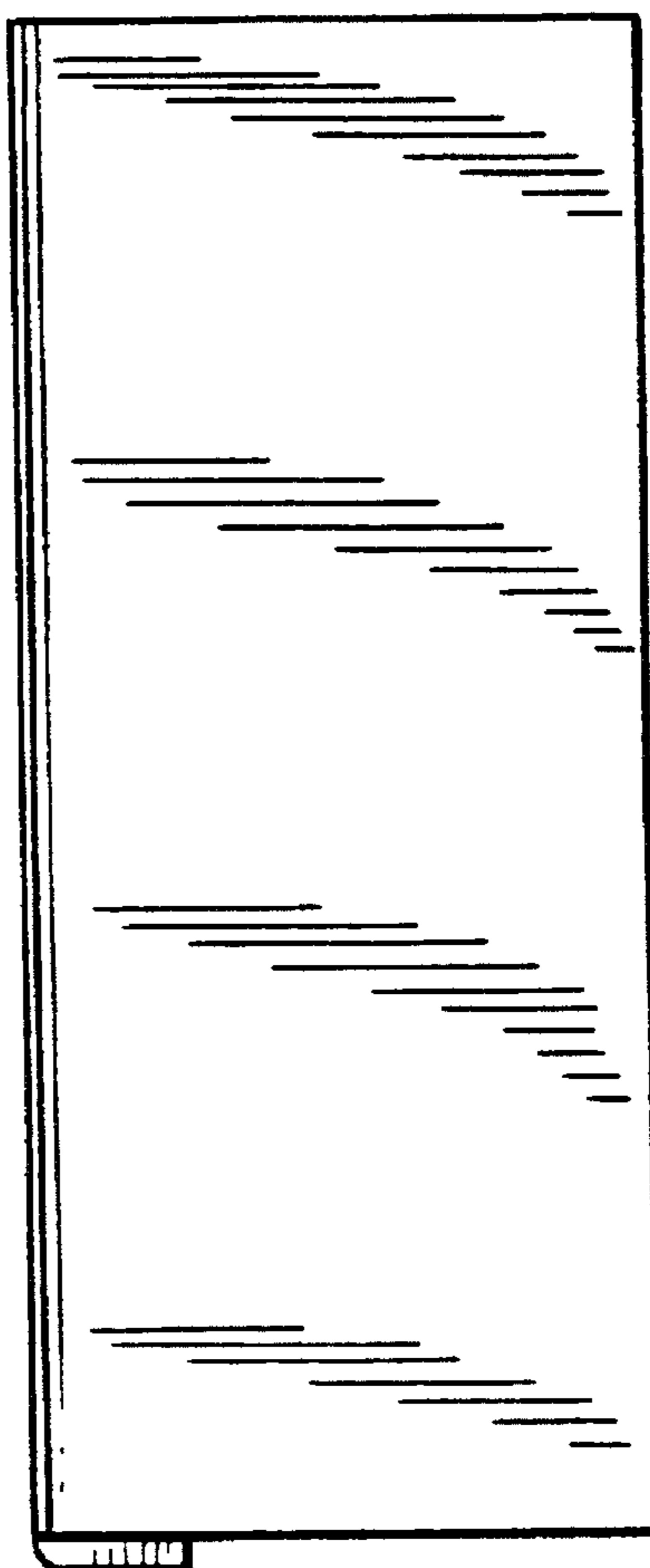

FIG. 4

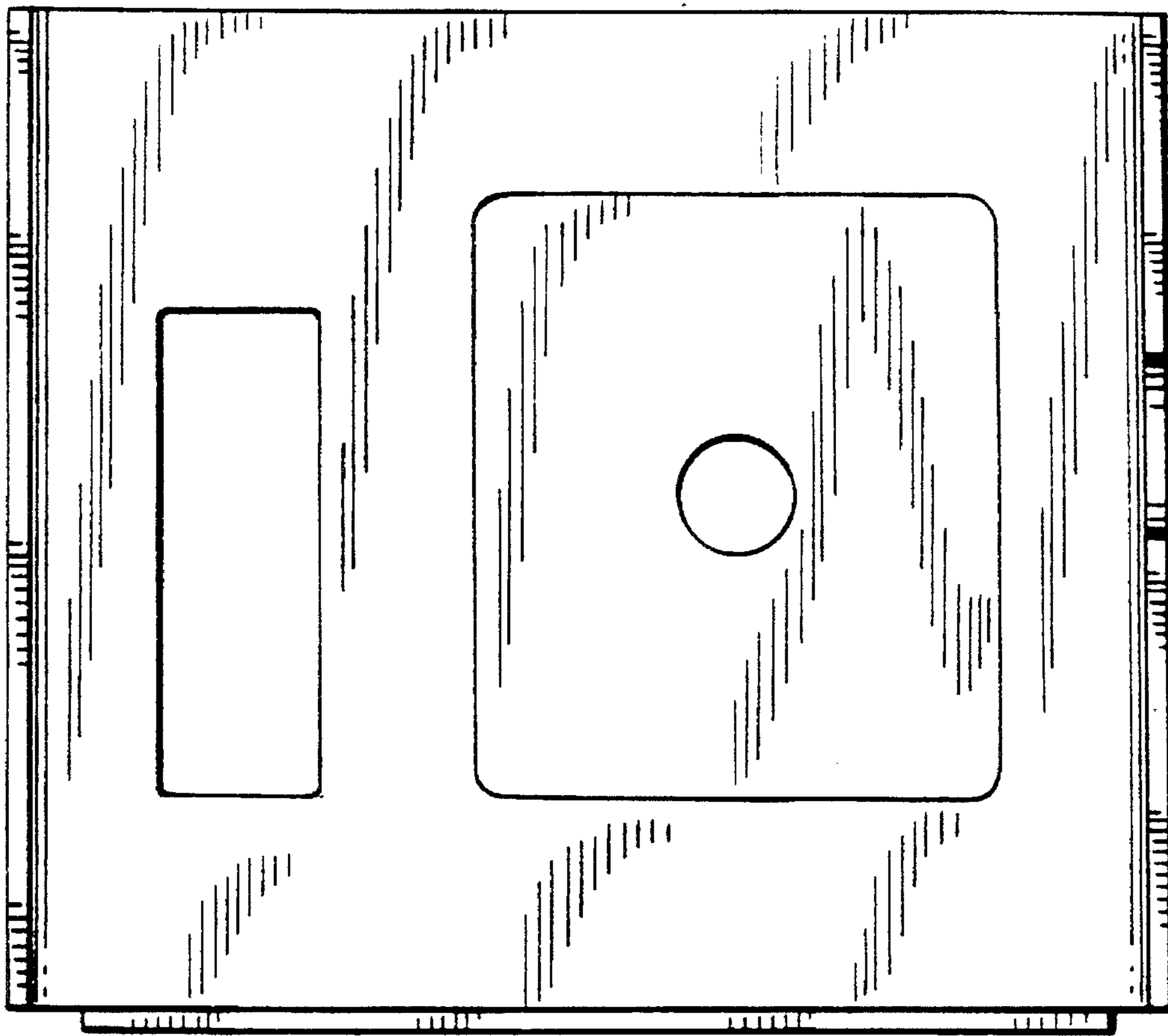

FIG. 5

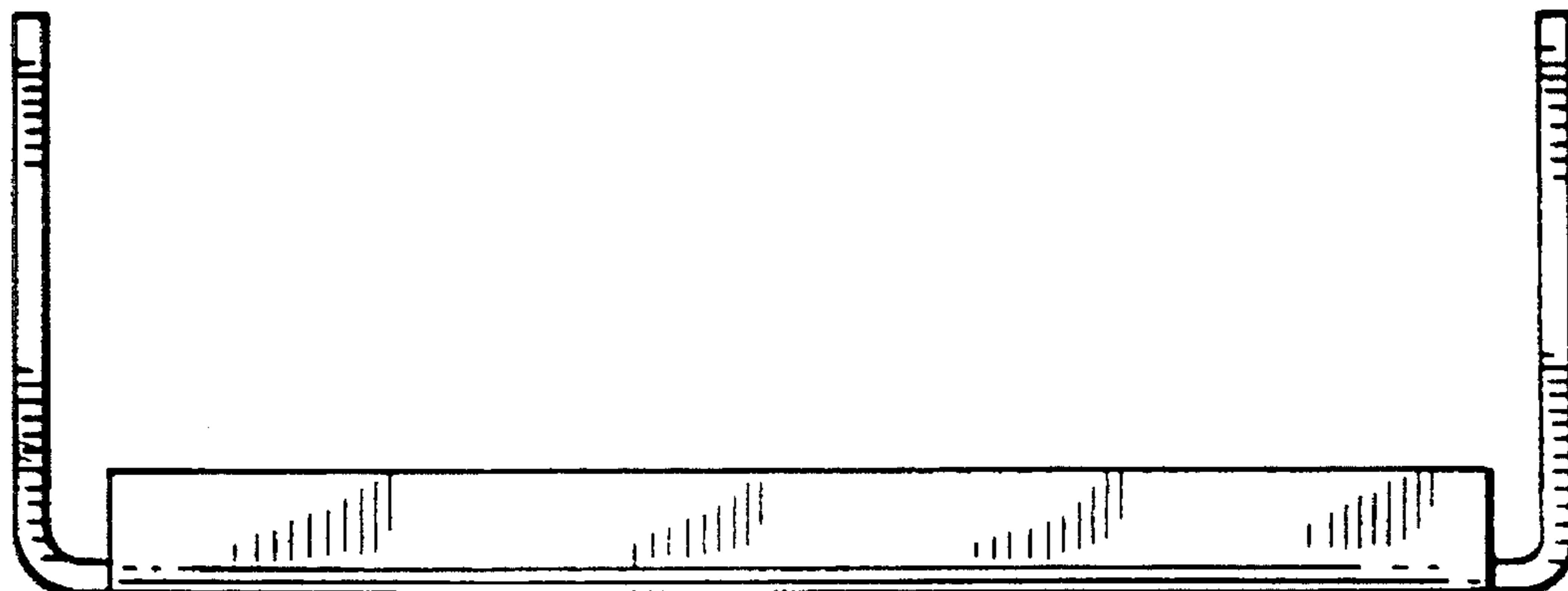

FIG. 6