



US00D378885S

United States Patent [19]

[11] Patent Number: **Des. 378,885**

Sparks

[45] Date of Patent: ****Apr. 22, 1997**

- [54] **GAS COOKTOP GRATE**
- [75] Inventor: **Walton E. Sparks**, Dublin, Ohio
- [73] Assignee: **White Consolidated Industries, Inc.**,
Cleveland, Ohio
- [**] Term: **14 Years**
- [21] Appl. No.: **48,809**
- [22] Filed: **Dec. 27, 1995**
- [52] U.S. Cl. **D7/408**
- [58] Field of Search D7/408, 402, 407,
D7/409.2; 126/214 C, 215, 211, 214; 99/422,
449

- 2,833,906 5/1958 Wingo 126/214 R
- 2,887,103 5/1959 Reeves .
- 4,413,610 11/1983 Berlik 126/214 R X

OTHER PUBLICATIONS

Abitare, Jul.-Aug. 1986, p. 48.

Primary Examiner—Louis S. Zarfaz

Assistant Examiner—Frank Martinez

Attorney, Agent, or Firm—Pearne, Gordon, McCoy & Granger

[57] CLAIM

The ornamental design for a gas cooktop grate, as shown and described.

DESCRIPTION

FIG. 1 shows a gas range having a gas cooktop grate according to the invention installed thereon;

FIG. 2 shows a top plan view of the assembled grate;

FIG. 3 shows an isometric view of a corner component of the grate, all four corner components being identical;

FIG. 4 shows a front view of the corner component;

FIG. 5 shows a top view of the corner component;

FIG. 6 shows a right side view of the corner component of FIG. 5;

FIG. 7 shows a rear view of the corner component;

FIG. 8 shows a bottom view of the corner component;

FIG. 9 shows a left side view of the corner component of FIG. 5;

FIG. 10 shows an isometric view of a center component of the grate, the two center components being identical;

FIG. 11 shows a front view of the center component;

FIG. 12 shows a top view of the center component;

FIG. 13 shows a right side view of the center component of FIG. 12;

FIG. 14 shows a rear view of the center component;

FIG. 15 shows a bottom view of the center component; and,

FIG. 16 shows a left side view of the center component of FIG. 12.

[56] References Cited

U.S. PATENT DOCUMENTS

- D. 34,415 4/1901 Buzzacott .
- D. 68,133 9/1925 Cooney .
- D. 85,696 12/1931 Hoffstetter et al. .
- D. 95,268 4/1935 Klute .
- D. 128,164 7/1941 Hennessy 216/214 C
- D. 137,567 3/1944 Yeager .
- D. 303,604 9/1989 Beach et al. .
- D. 340,835 11/1993 Lupa et al. .
- 1,168,852 1/1916 Caverly .
- 1,435,938 11/1922 O'Dowd .
- 1,532,839 4/1925 Sherman .
- 1,663,438 3/1928 Brumbaugh .
- 1,869,711 8/1932 Olsen, Jr. et al. .
- 1,940,080 12/1933 Dollin et al. .
- 1,942,265 1/1934 Teller et al. .
- 1,998,999 4/1935 Toomey .
- 2,005,242 6/1935 Rogers .
- 2,252,753 8/1941 Brodbeck .
- 2,279,063 4/1942 Rogers .
- 2,321,167 6/1943 Taft .
- 2,430,079 11/1947 Reeves .
- 2,485,359 10/1949 Cook et al. 126/214 R
- 2,594,215 4/1952 Resek .
- 2,778,356 1/1957 Pugach 126/211
- 2,828,919 4/1958 Hillebrand 126/214 R

1 Claim, 7 Drawing Sheets

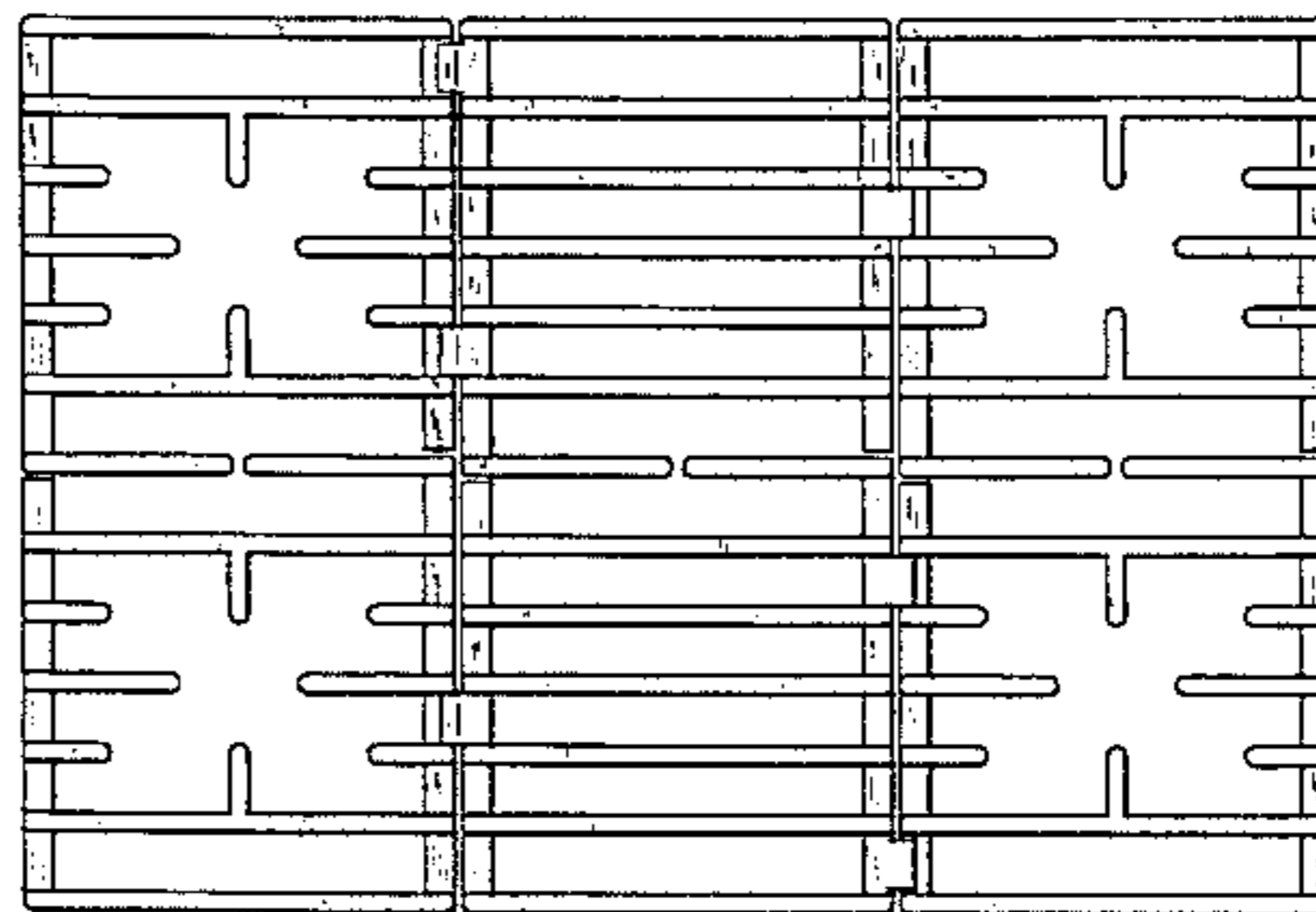
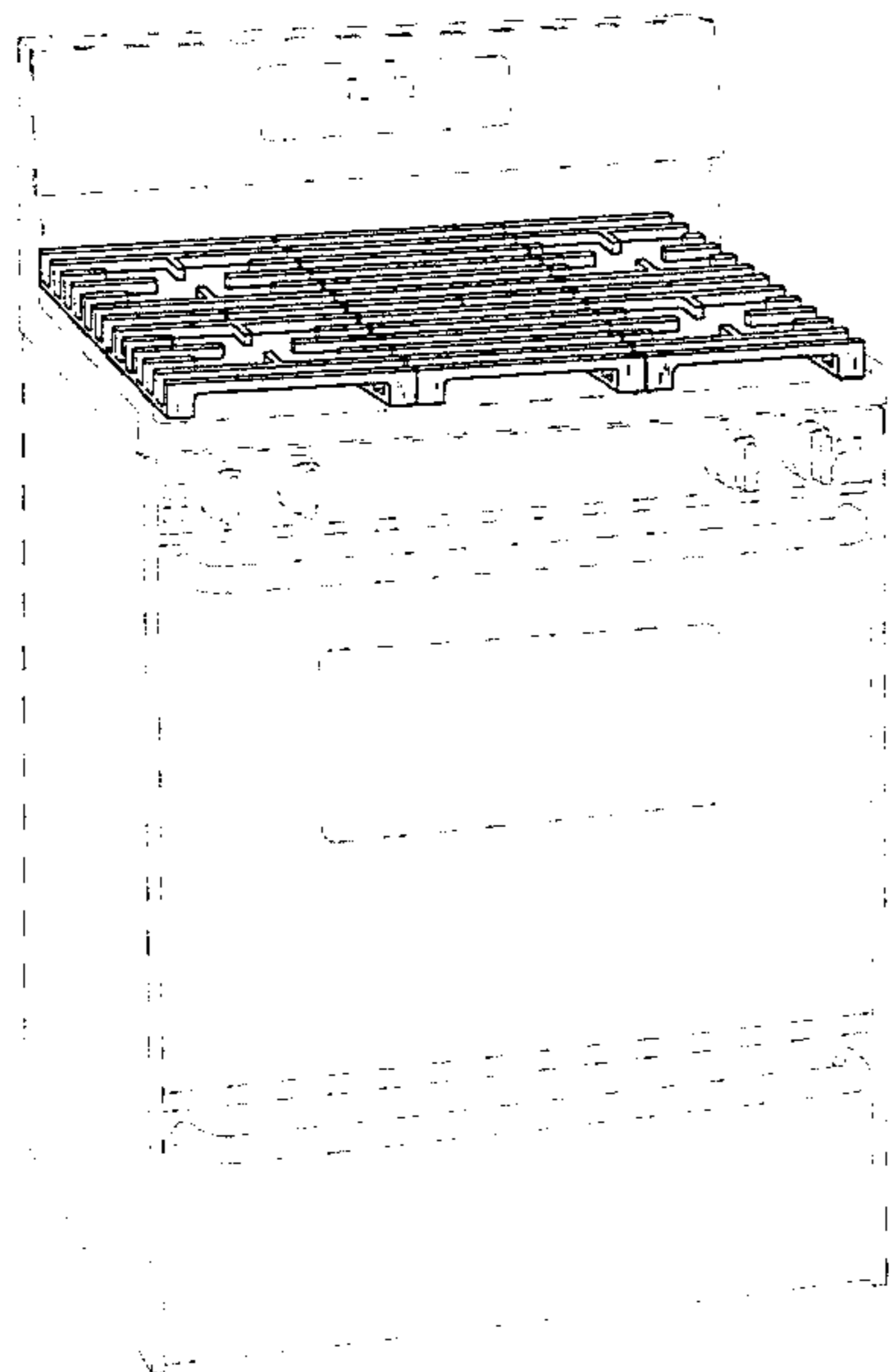

Fig. 1

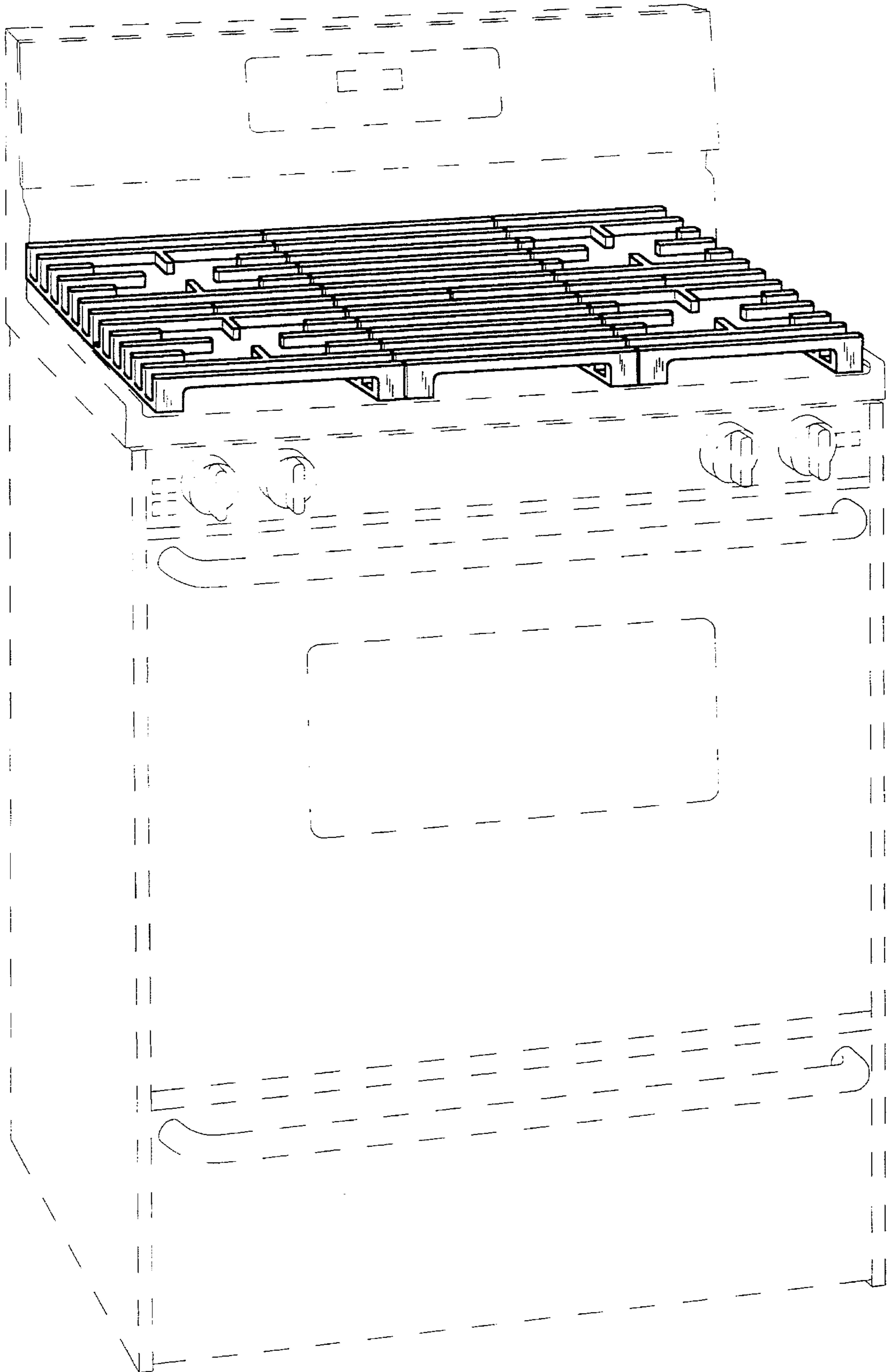

Fig. 2

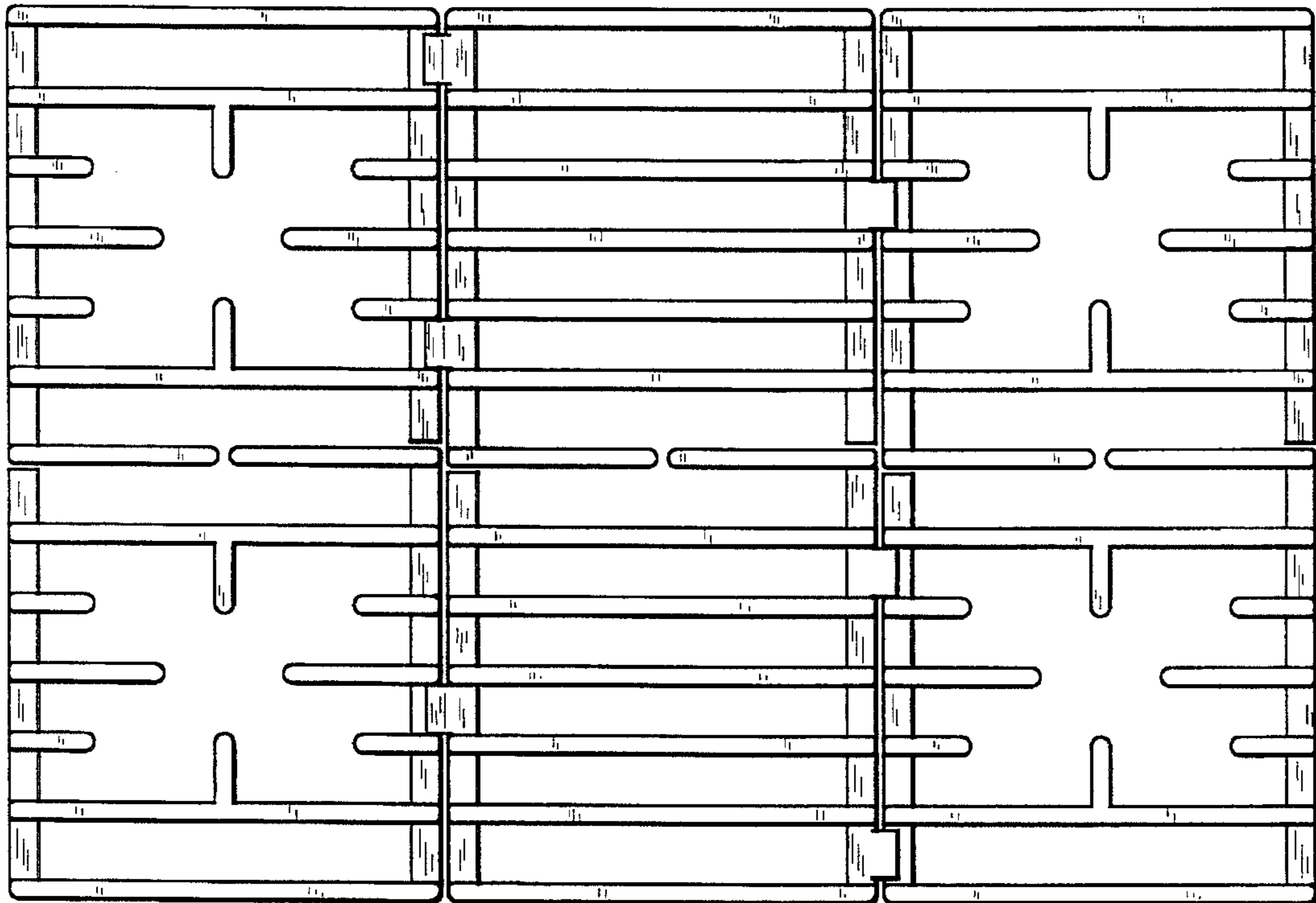

Fig. 3

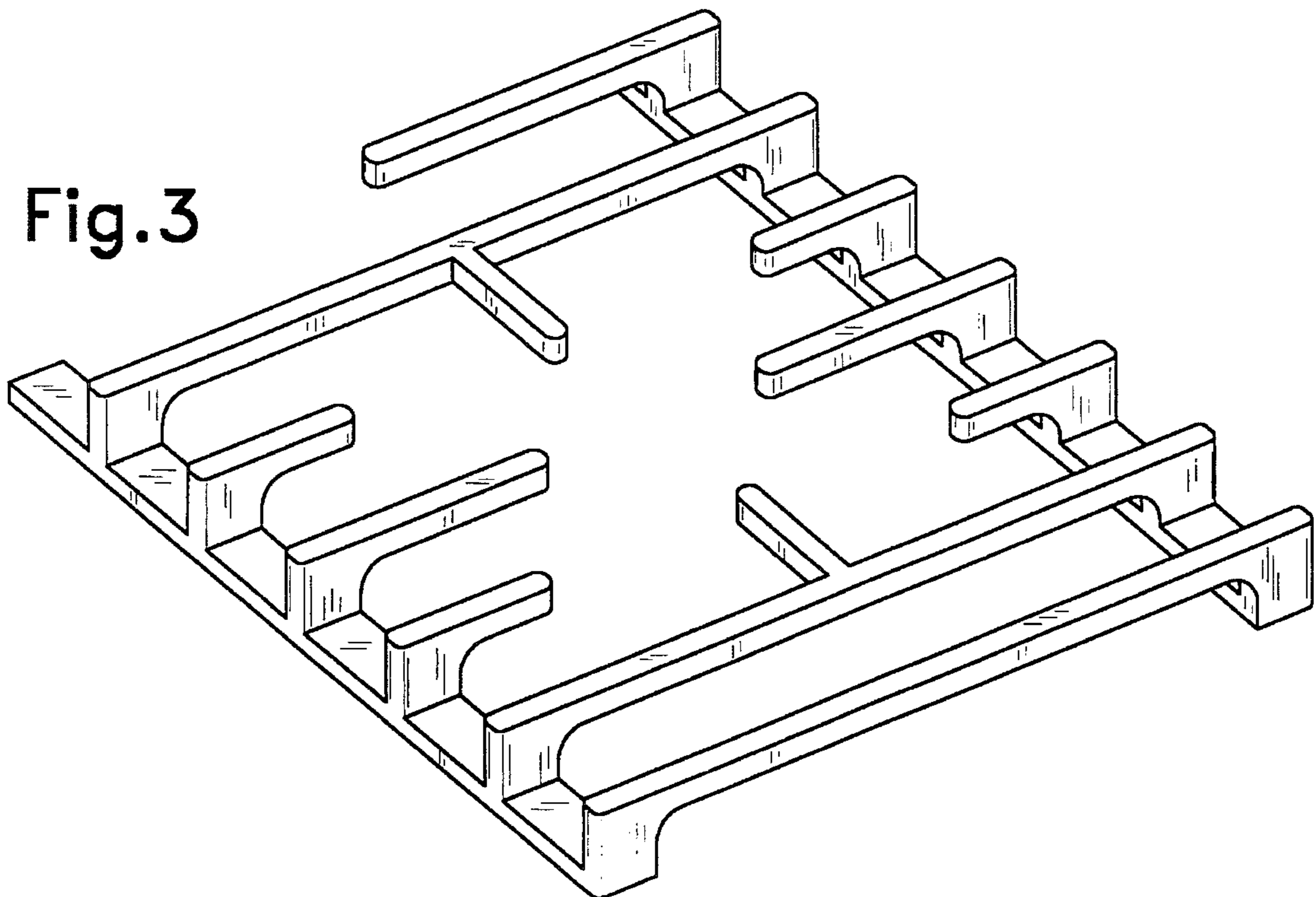

Fig.5

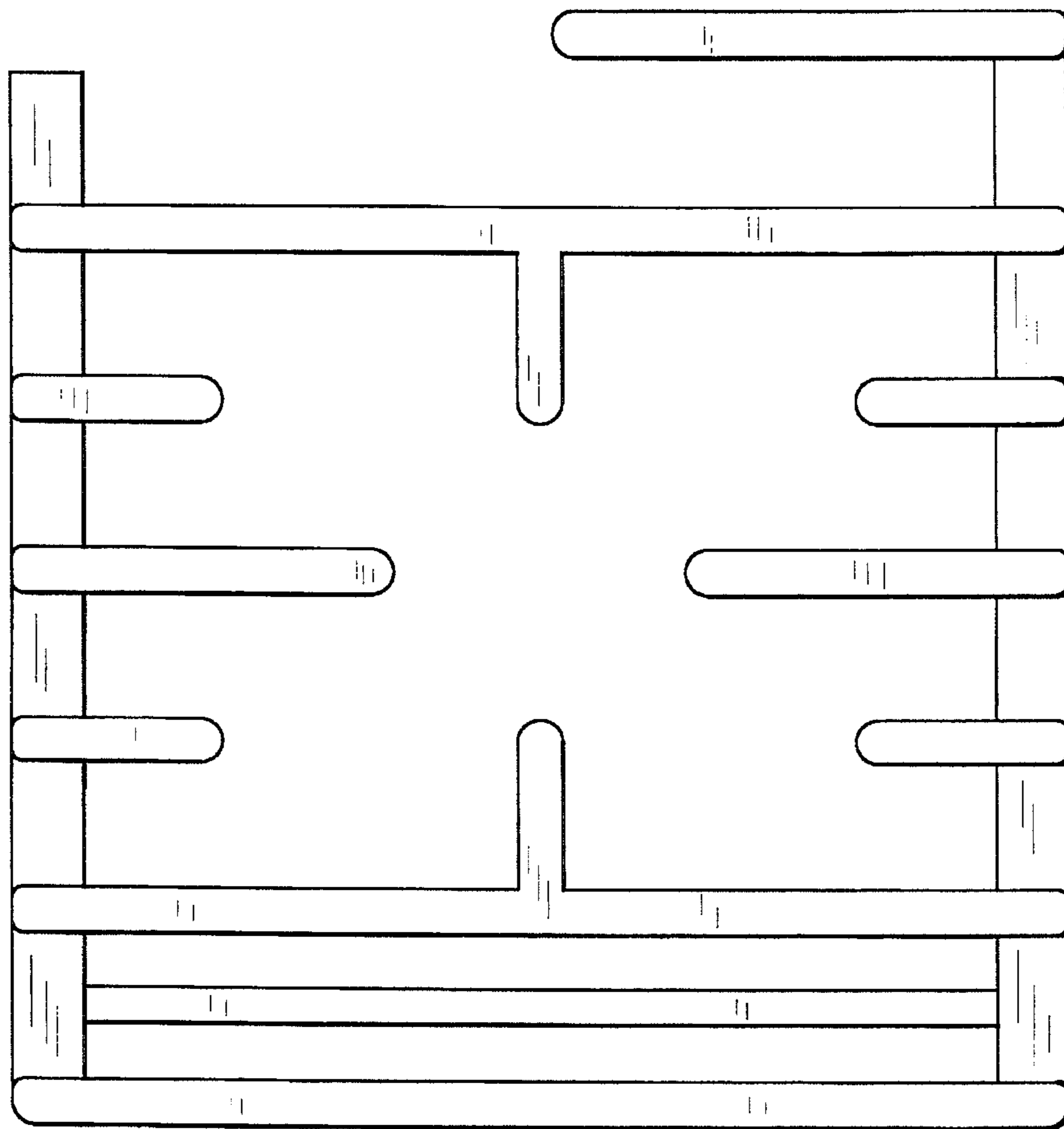

Fig.4

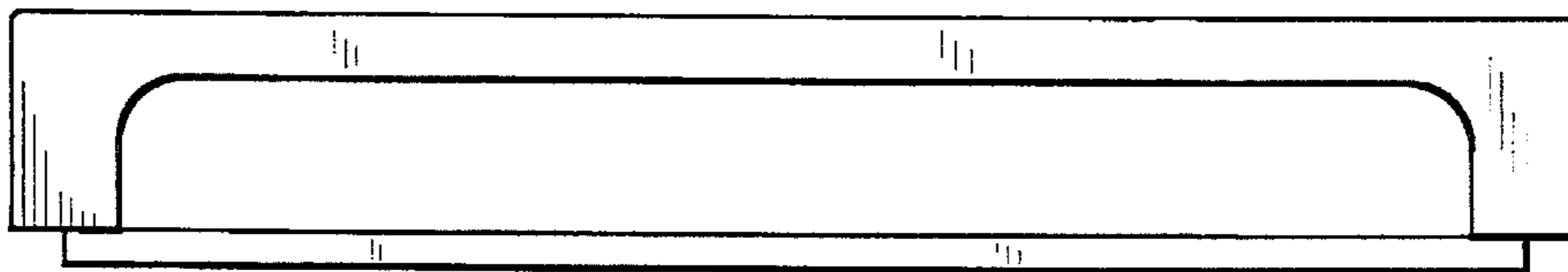

Fig.6

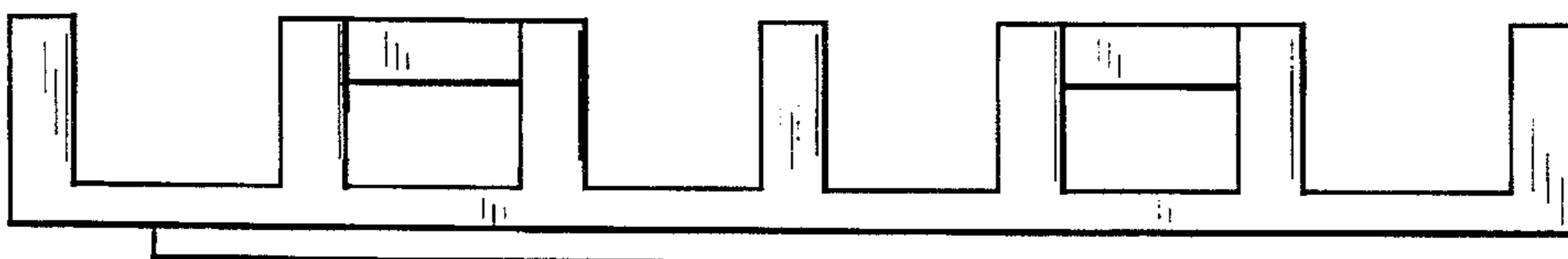

Fig.8

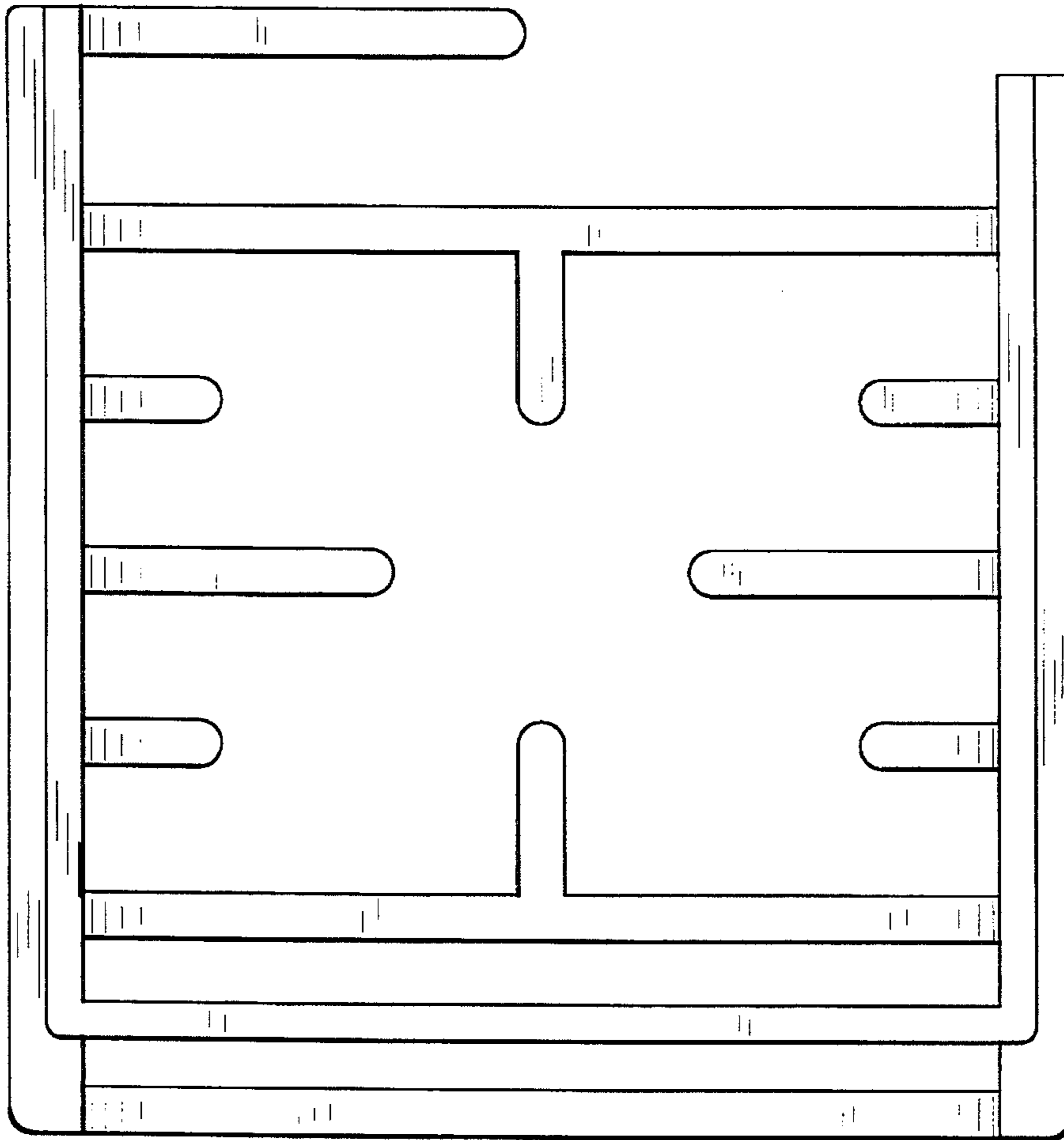

Fig.7

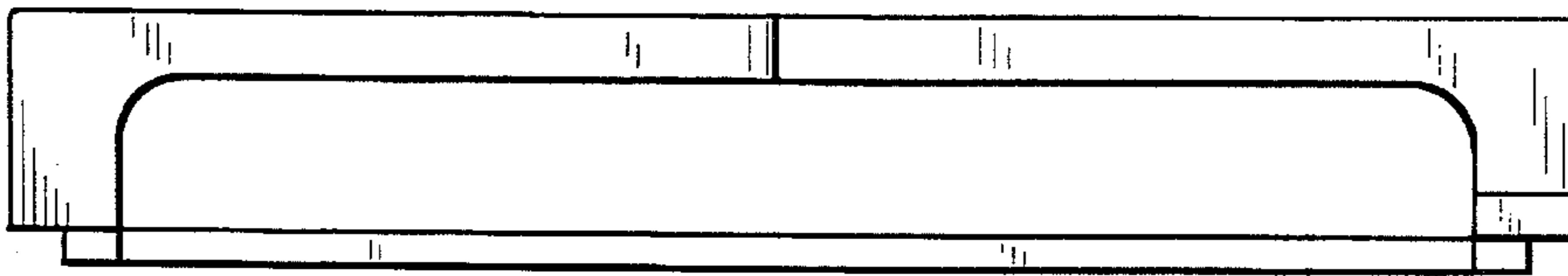

Fig.9

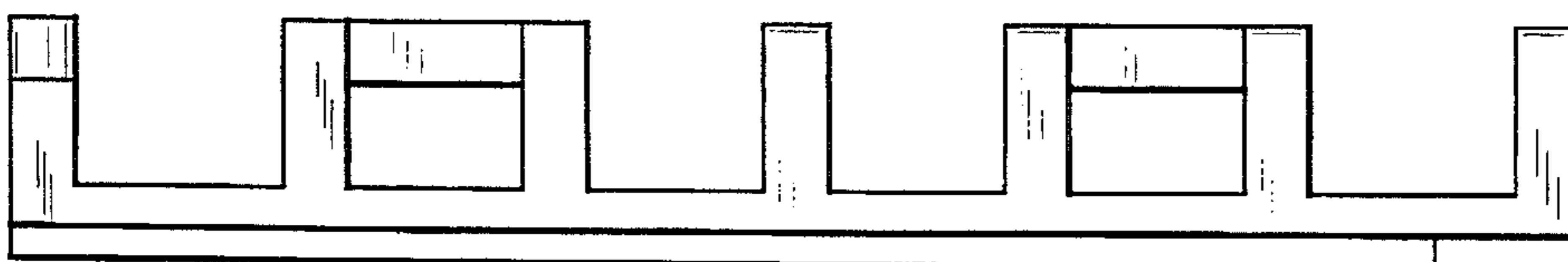

Fig.10

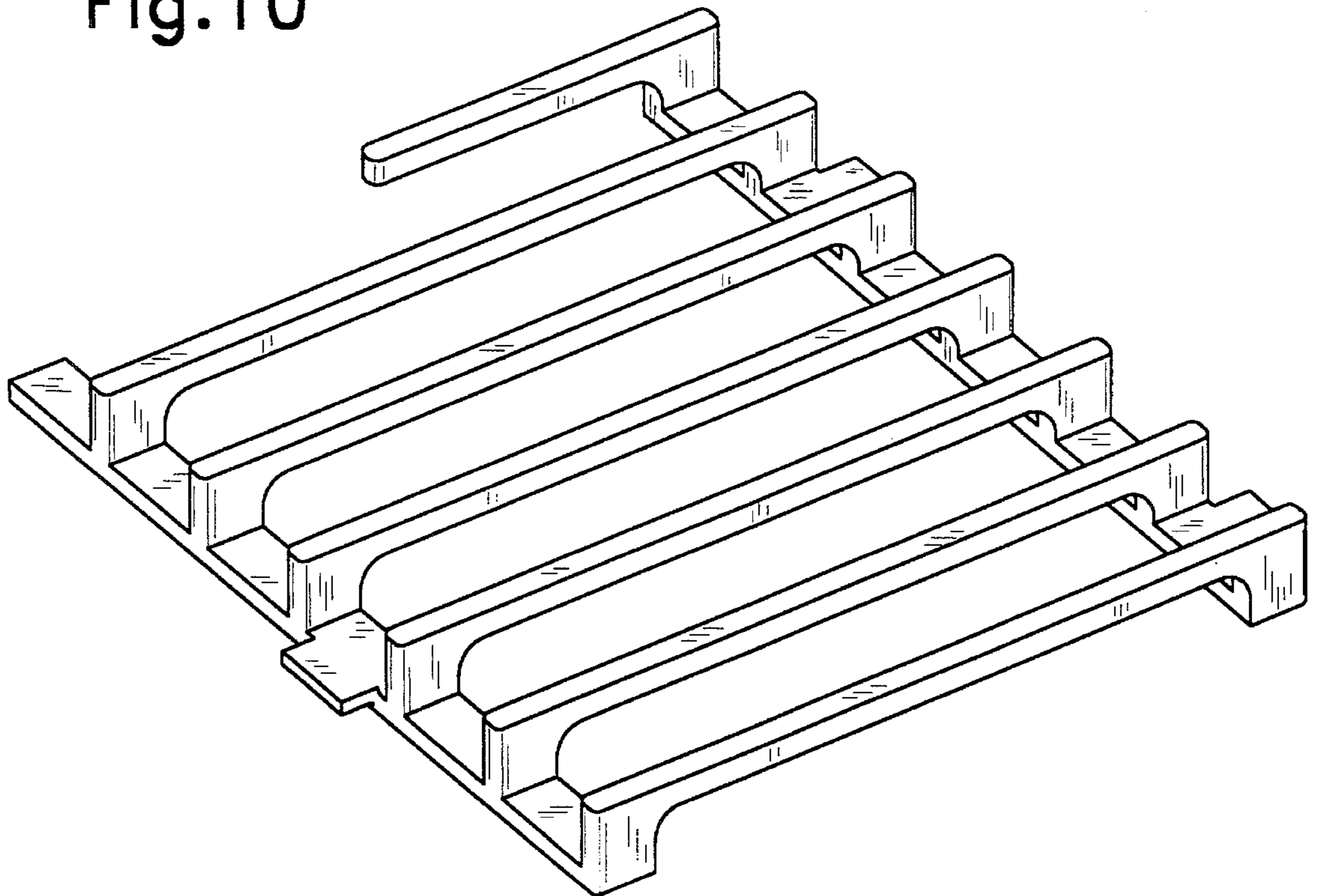

Fig. 12

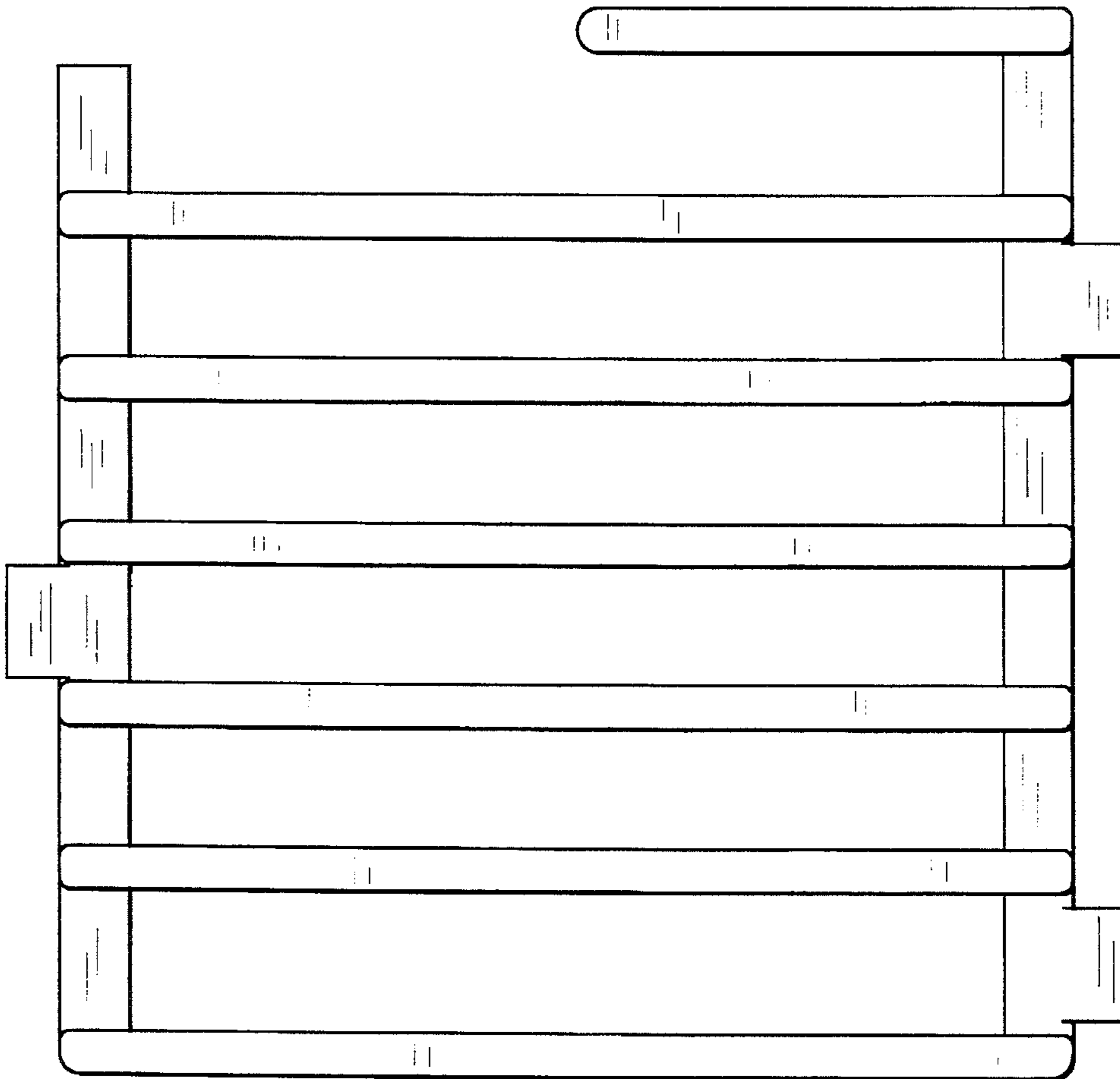

Fig. 11

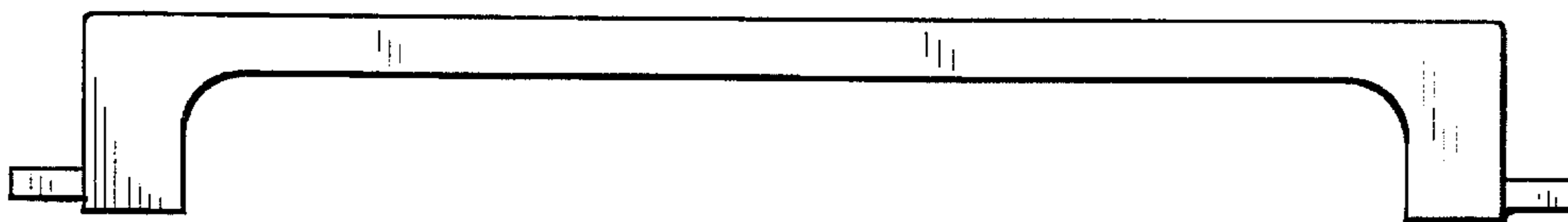

Fig. 13

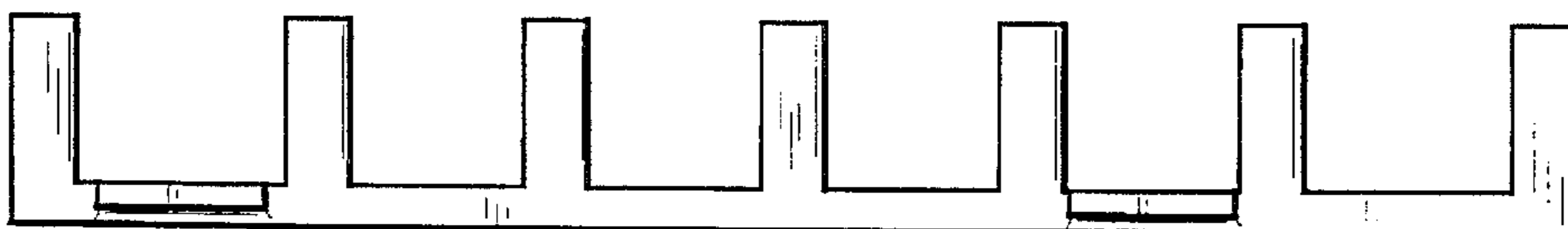

Fig. 15

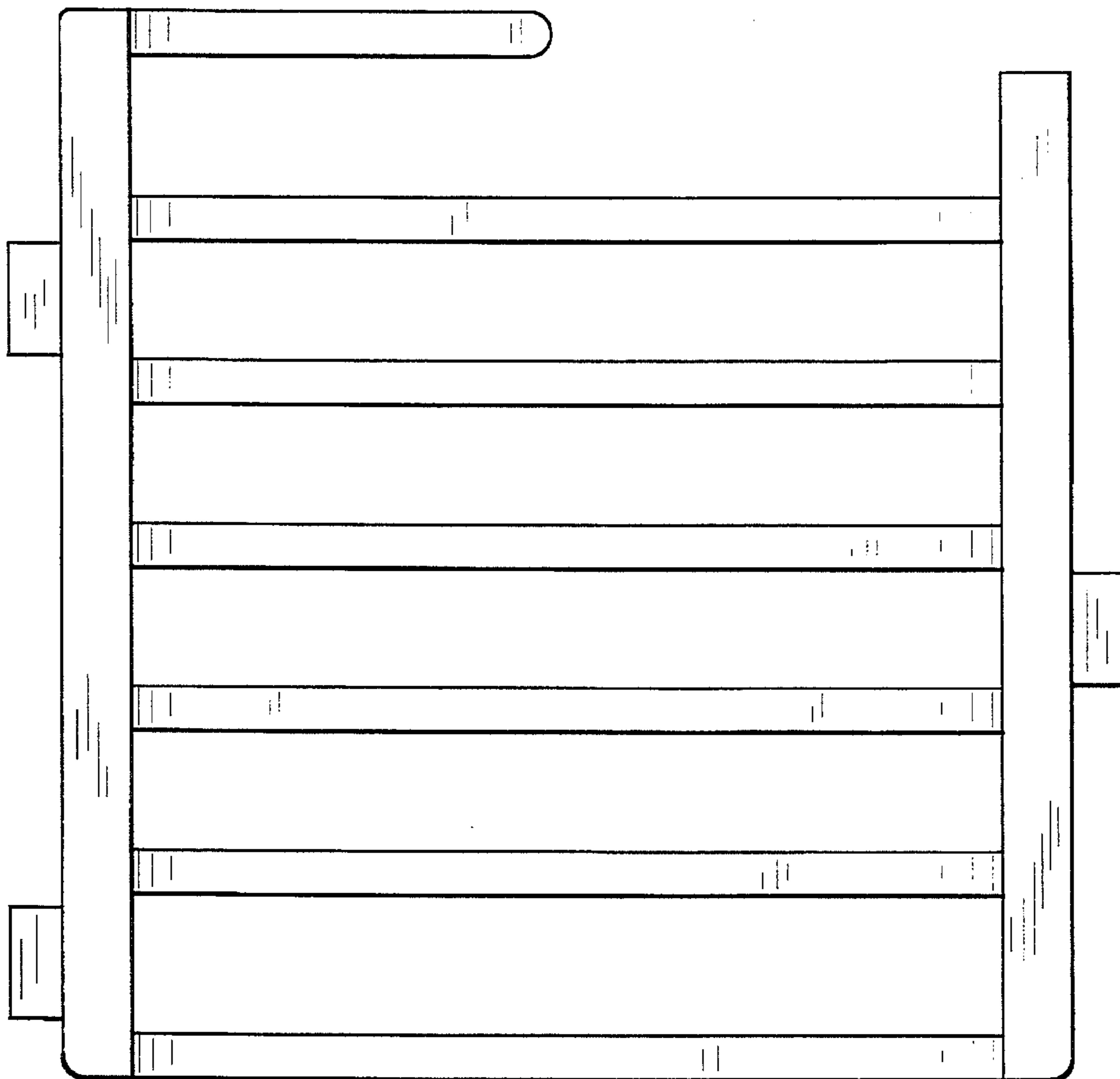

Fig. 14

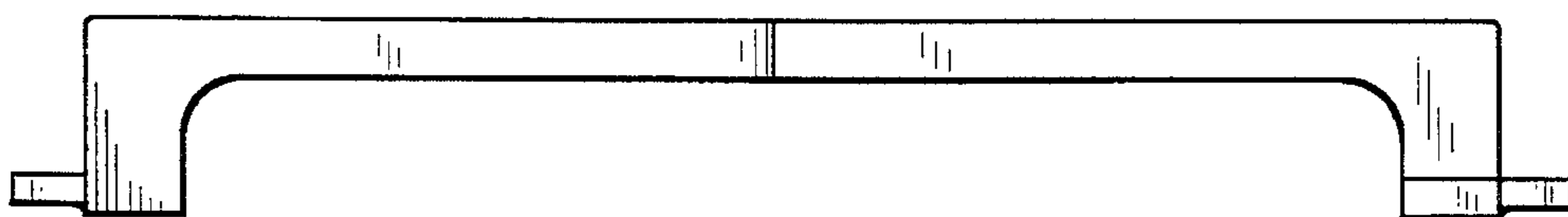

Fig. 16

