



US00D378860S

United States Patent [19]

Galletly

[11] Patent Number: **Des. 378,860**

[45] Date of Patent: ****Apr. 15, 1997**

[54] LIGHTING FIXTURE

4,494,175 1/1985 Gawad et al. 362/225 X

[75] Inventor: **Kenneth Galletly**, Winchcombe, Great Britain

Primary Examiner—Susan J. Lucas
Attorney, Agent, or Firm—Fish & Richardson P.C.

[73] Assignee: **The Louvre Company Ltd.**, London, England

[57] **CLAIM**

[**] Term: **14 Years**

The ornamental design for a lighting fixture, as shown and described.

[21] Appl. No.: **44,900**

DESCRIPTION

[22] Filed: **Oct. 3, 1995**

FIG. 1 is a perspective view of a lighting fixture showing my new design;

[30] **Foreign Application Priority Data**

FIG. 2 is a top plan view of the lighting fixture shown in FIG. 1;

Apr. 6, 1995 [GB] United Kingdom 2046592

FIG. 3 is a bottom plan view of the lighting fixture shown in FIG. 1;

[52] U.S. Cl. **D26/77**

[58] Field of Search D26/75-79; 362/147, 362/217, 220, 224, 225, 279, 290, 325

FIGS. 4 and 5 are right and left end elevational views of the lighting fixture shown in FIG. 1; and,

[56] **References Cited**

FIGS. 6 and 7 are front and back elevational views of the lighting fixture shown in FIG. 1.

U.S. PATENT DOCUMENTS

2,606,998 7/1952 Winkler et al. 362/220

1 Claim, 2 Drawing Sheets

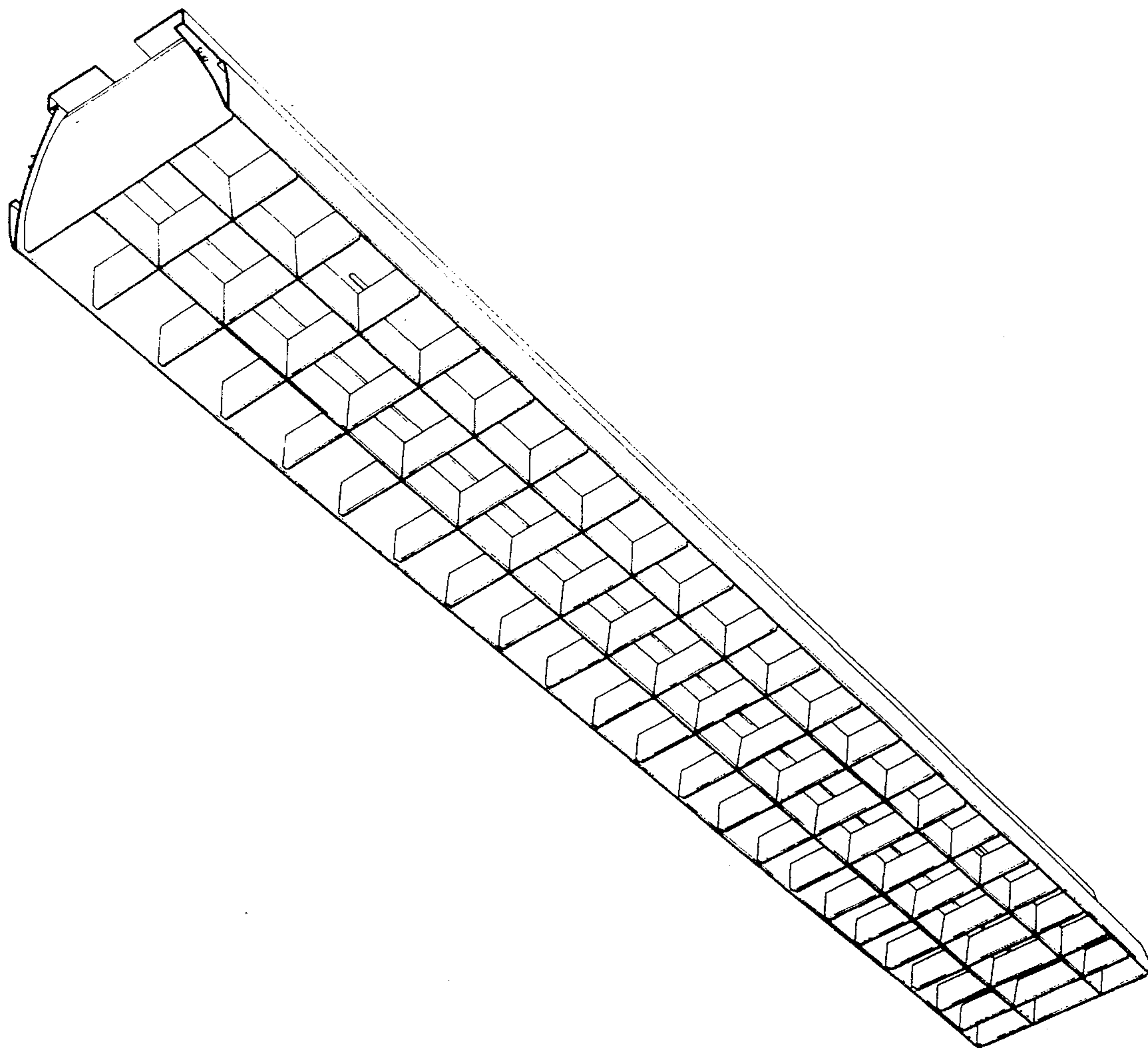

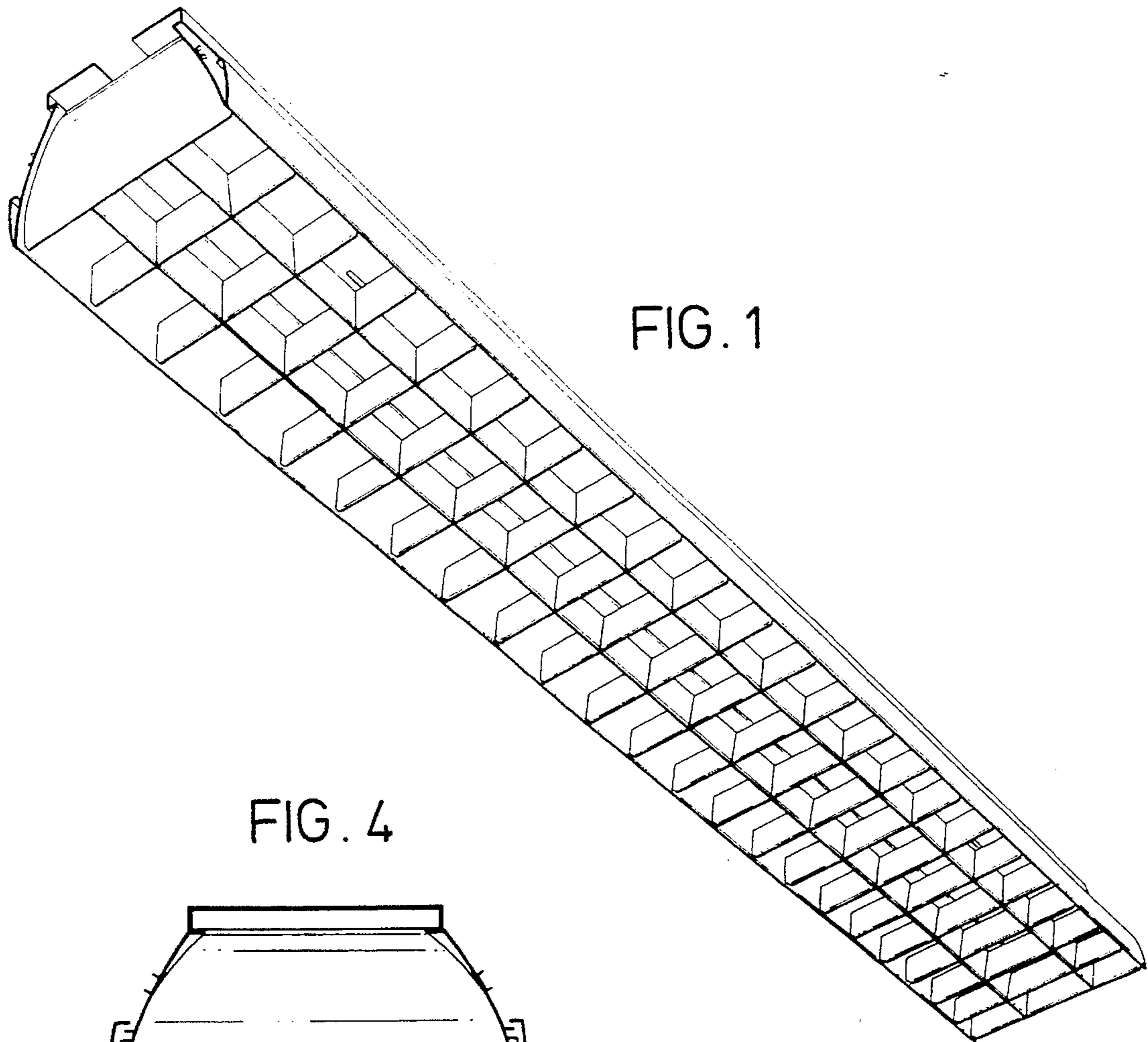

FIG. 1

FIG. 4

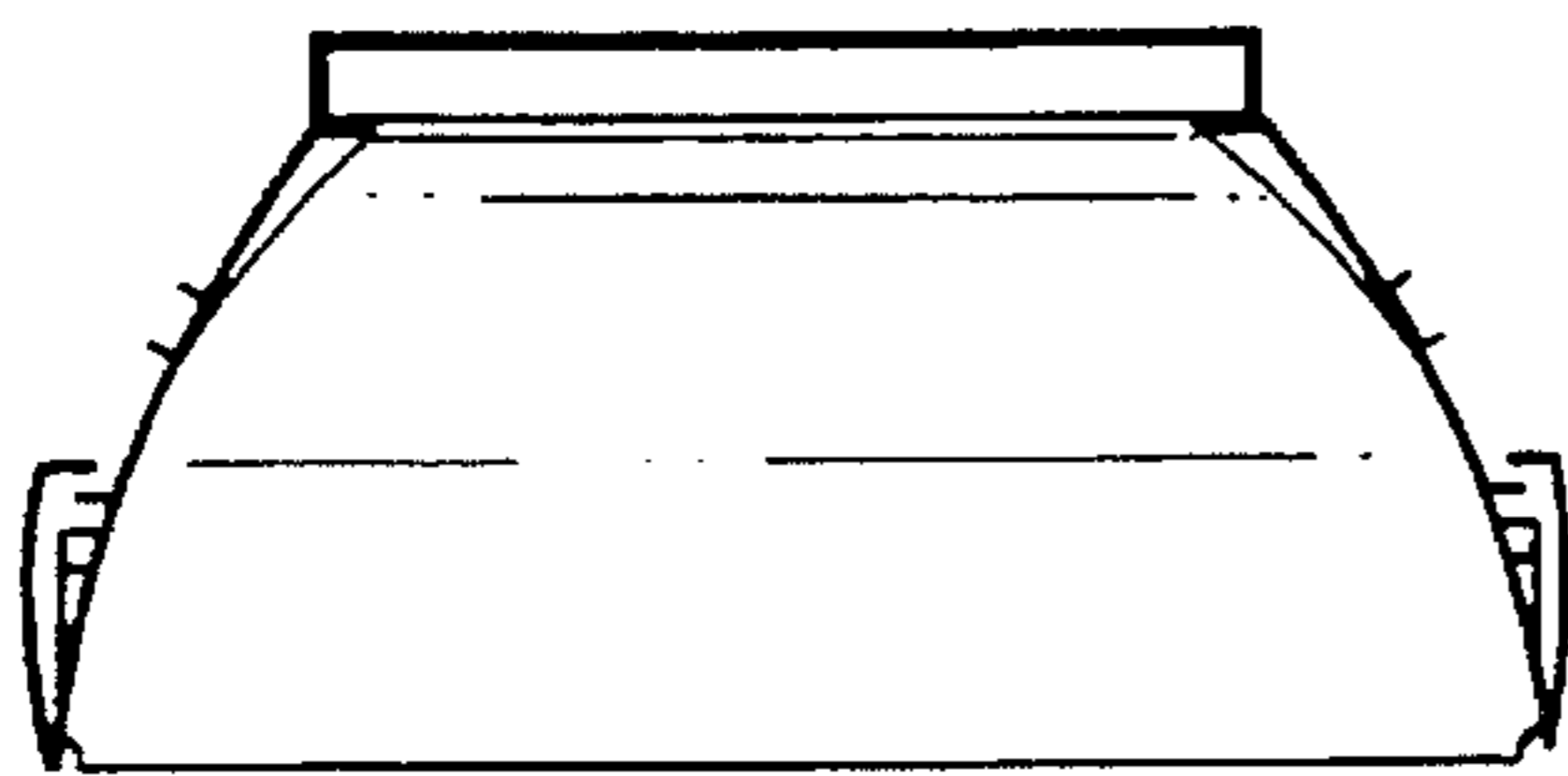

FIG. 5

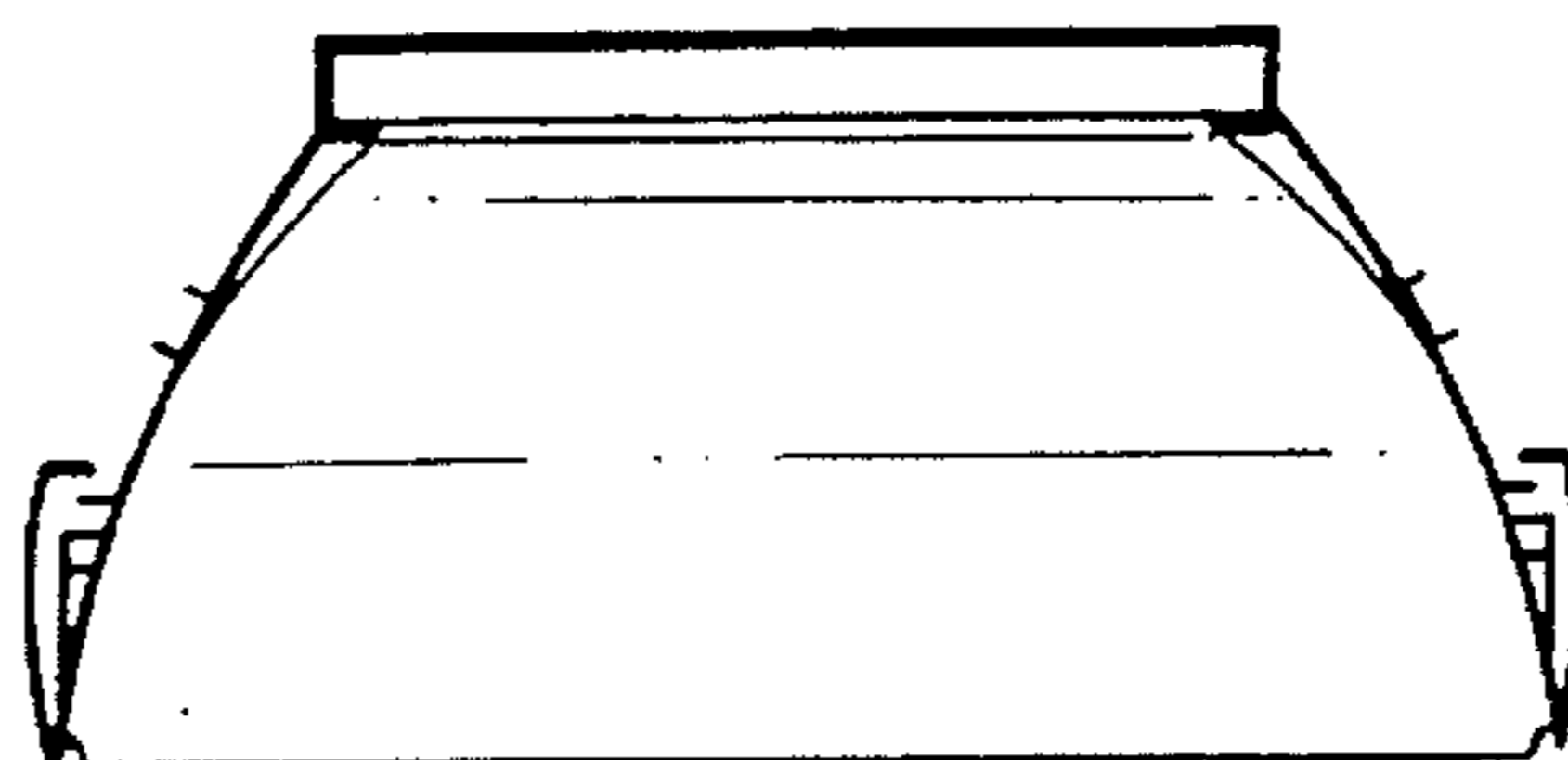

FIG. 2

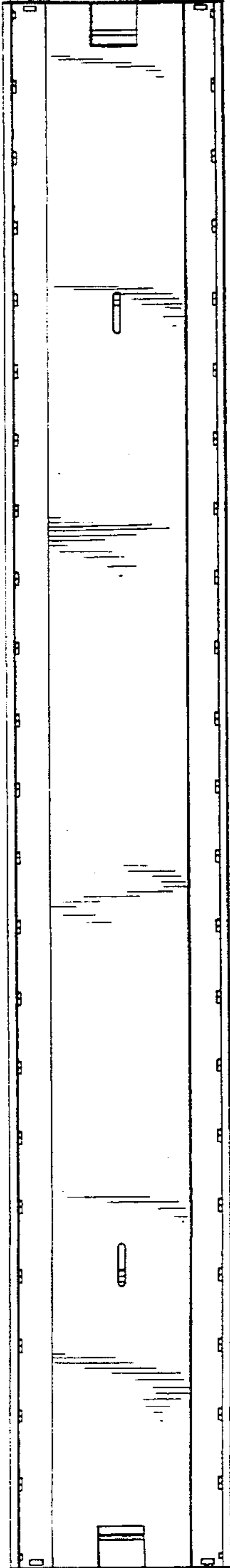

FIG. 3

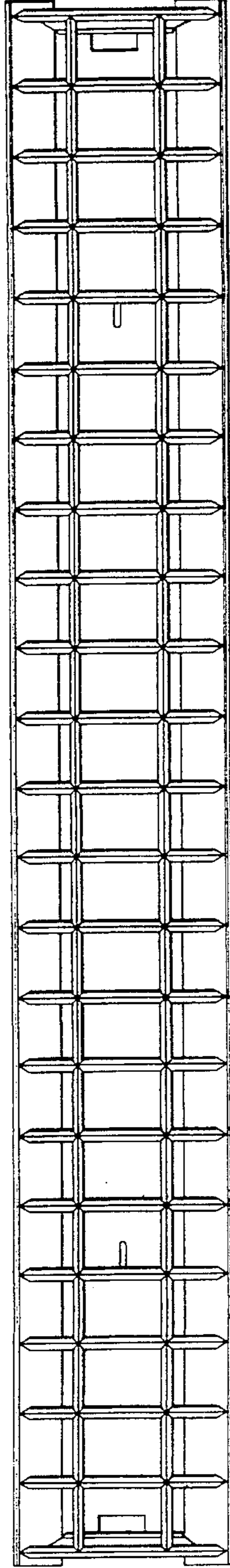

FIG. 6

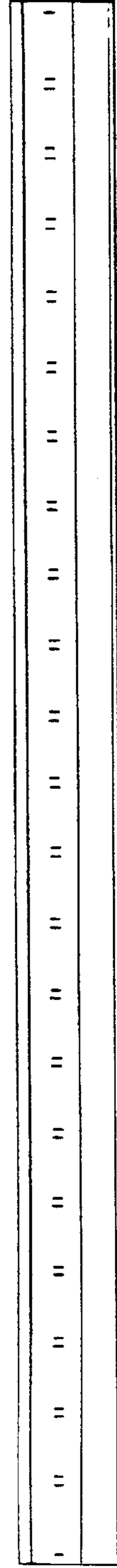

FIG. 7

