



US00D378828S

United States Patent [19]

Harden

[11] Patent Number: **Des. 378,828**

[45] Date of Patent: ****Apr. 15, 1997**

[54] STAMPER

[75] Inventor: **Dan Harden**, Palo Alto, Calif.

[73] Assignee: **Shachihata Inc.**, Aichi-ken, Japan

[**] Term: **14 Years**

[21] Appl. No.: **51,127**

[22] Filed: **Mar. 4, 1996**

[30] Foreign Application Priority Data

Sep. 7, 1995 [JP] Japan 7-26517

[52] U.S. Cl. **D18/15**

[58] Field of Search D18/18, 16, 15,
D18/17; 118/264, 268; 101/333, 327, 405,
406

[56] References Cited

U.S. PATENT DOCUMENTS

D. 232,484	8/1974	Michels	D18/17	X
D. 266,257	9/1982	Ahrens	D18/15	
D. 293,921	1/1988	Harris	D18/15	
2,089,549	8/1937	Grant	101/333	
2,891,472	6/1959	Holzer	101/405	
4,492,162	1/1985	Nettesheim et al.	101/405	X

OTHER PUBLICATIONS

Marking Industry Magazine—Xstamper Advert. p. 19 Bottom, May 1991.

Primary Examiner—Louis S. Zarfes
Assistant Examiner—Frank Martinez
Attorney, Agent, or Firm—Keck, Mahin & Cate

[57] CLAIM

The ornamental design for a stamper, as shown.

DESCRIPTION

FIG. 1 is a perspective view of a stamper embodying my design;
FIG. 2 is a front elevational view of the stamper of FIG. 1;
FIG. 3 is a rear elevational view thereof;
FIG. 4 is a right side elevational view thereof;
FIG. 5 is a top plan view thereof;
FIG. 6 is a bottom plan view thereof;
FIG. 7 is a longitudinal cross-sectional view of the stamper taken along line 7—7 of FIG. 2; and,
FIG. 8 is a cross-sectional view of the stamper taken along line 8—8 of FIG. 4.

1 Claim, 2 Drawing Sheets

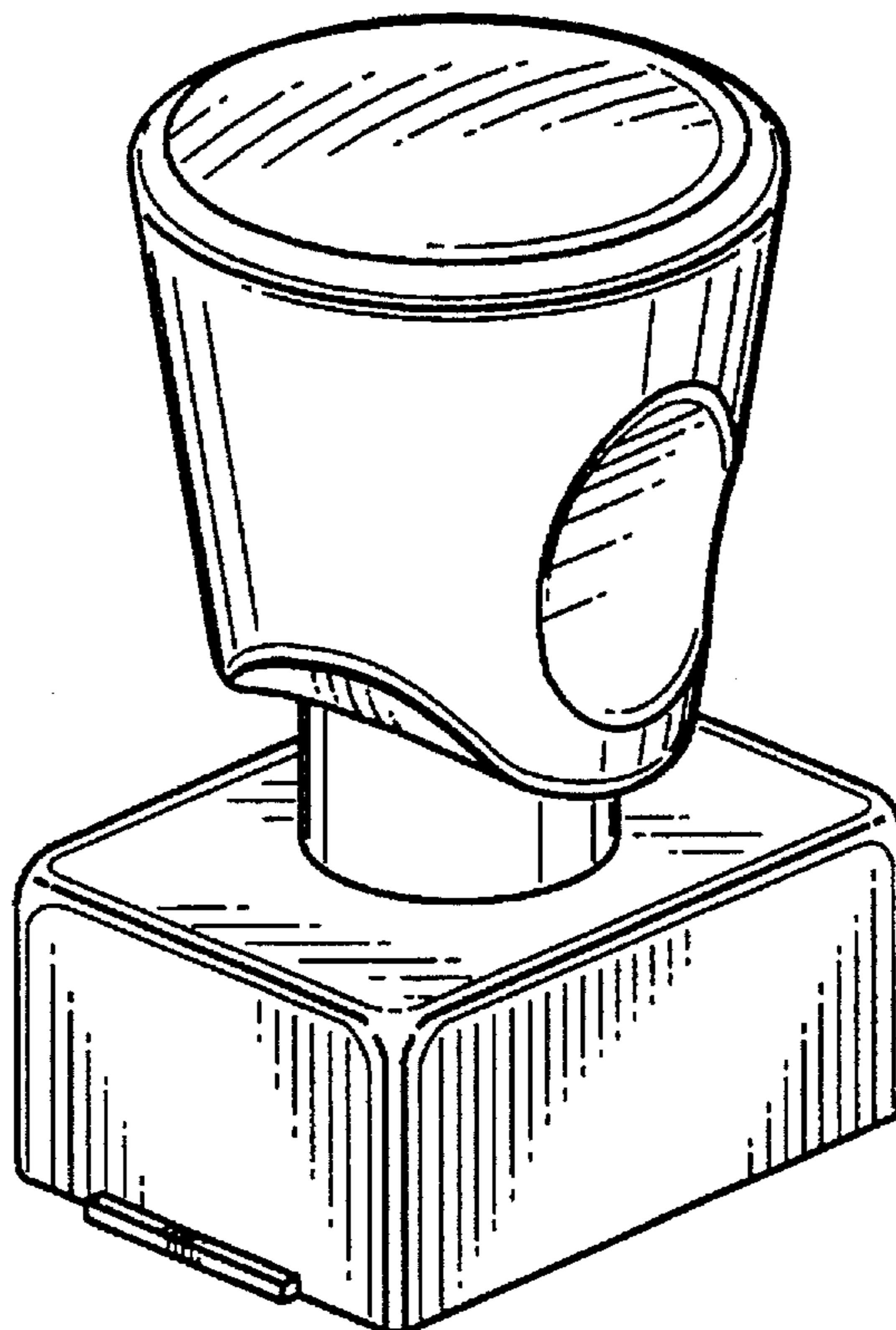

FIG. 1

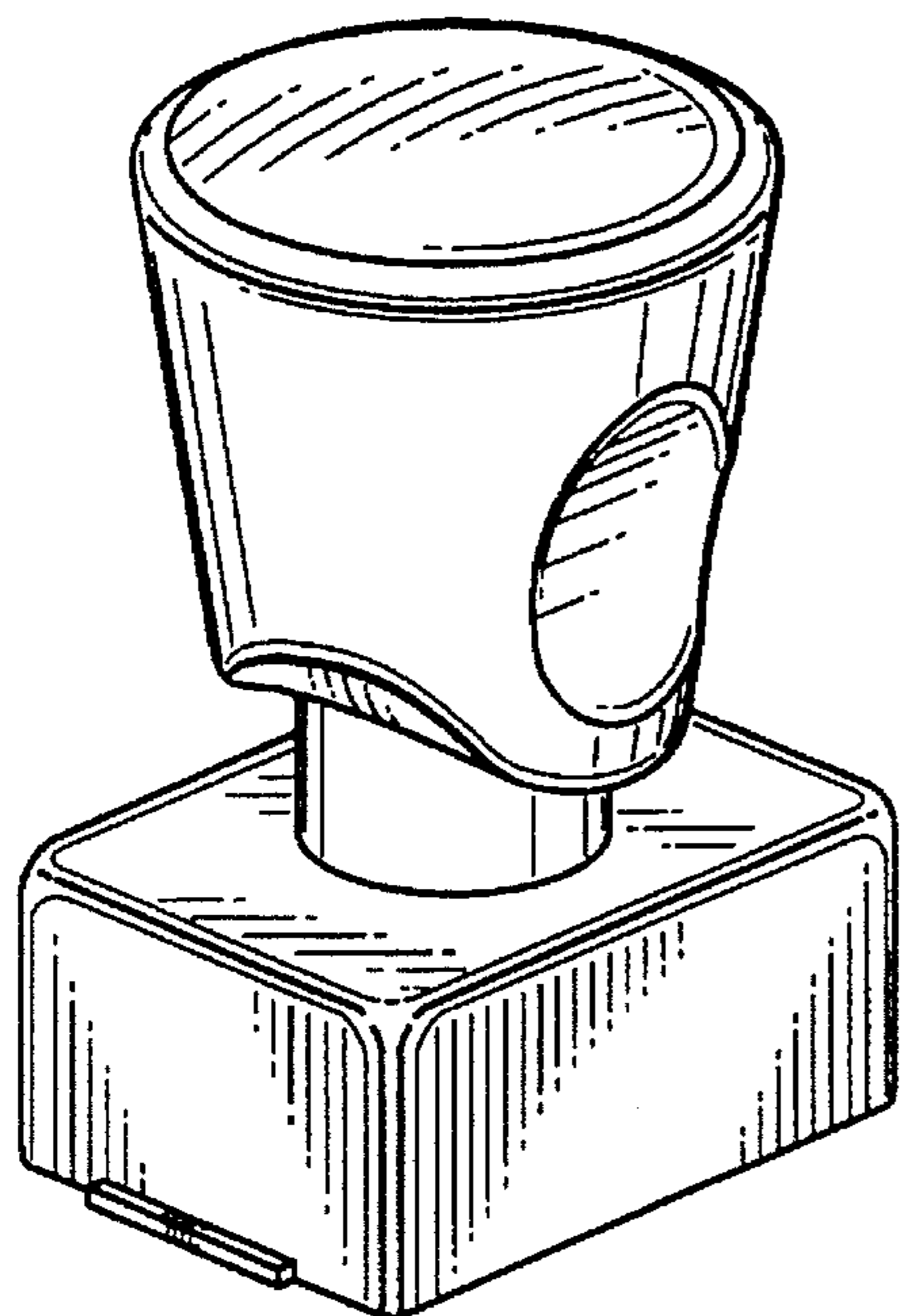

FIG. 2

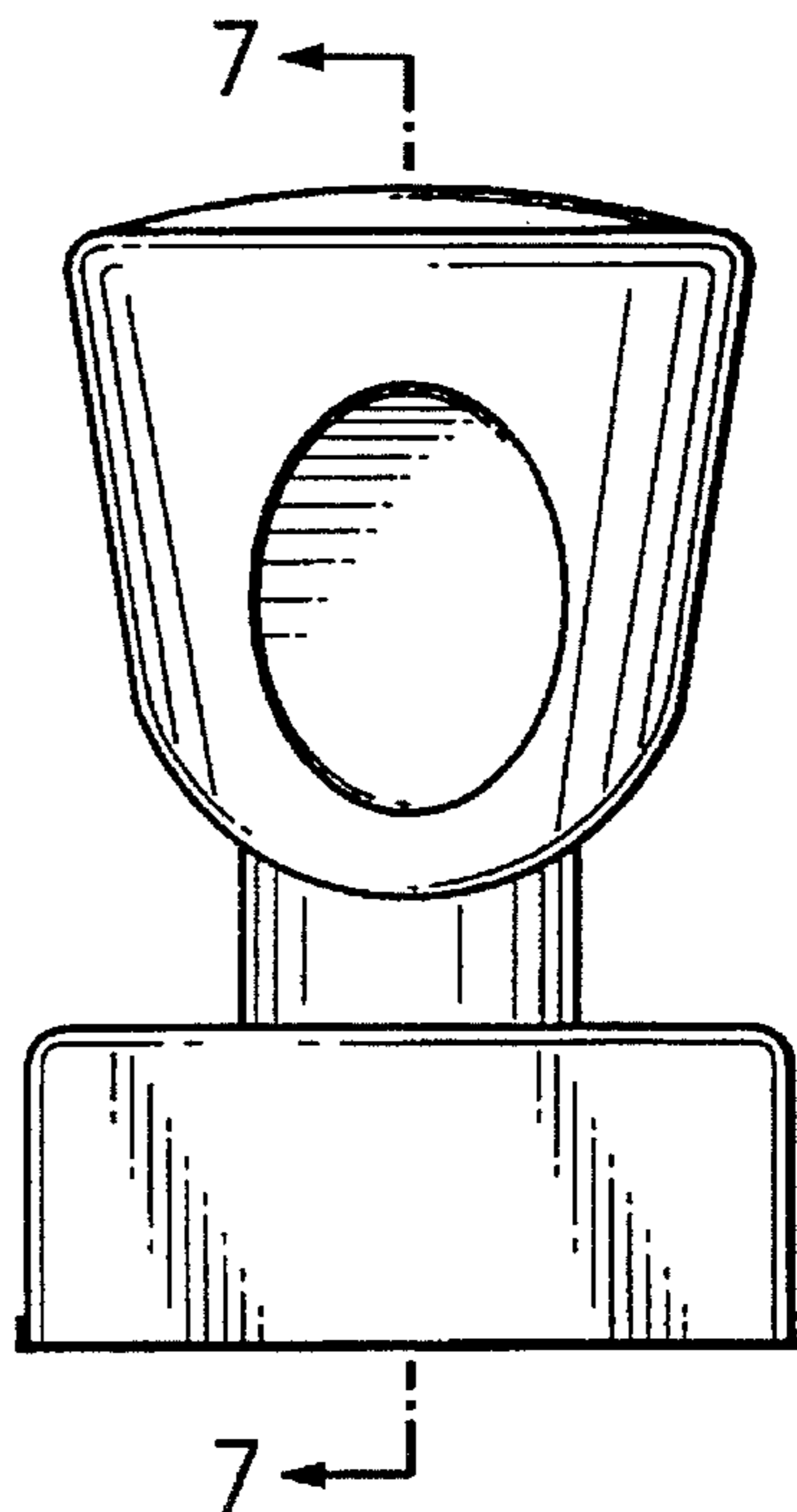

FIG. 3

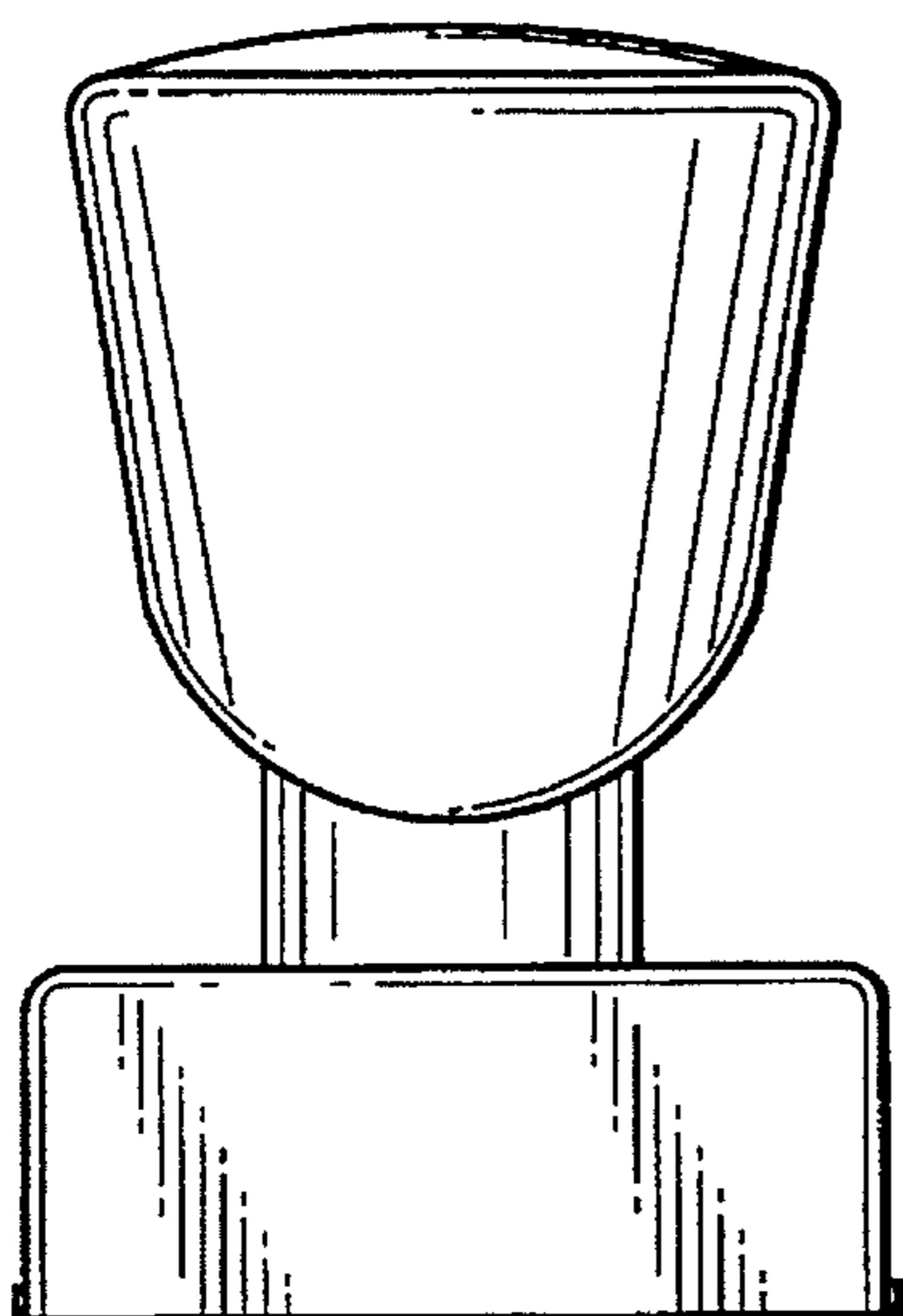

FIG. 4

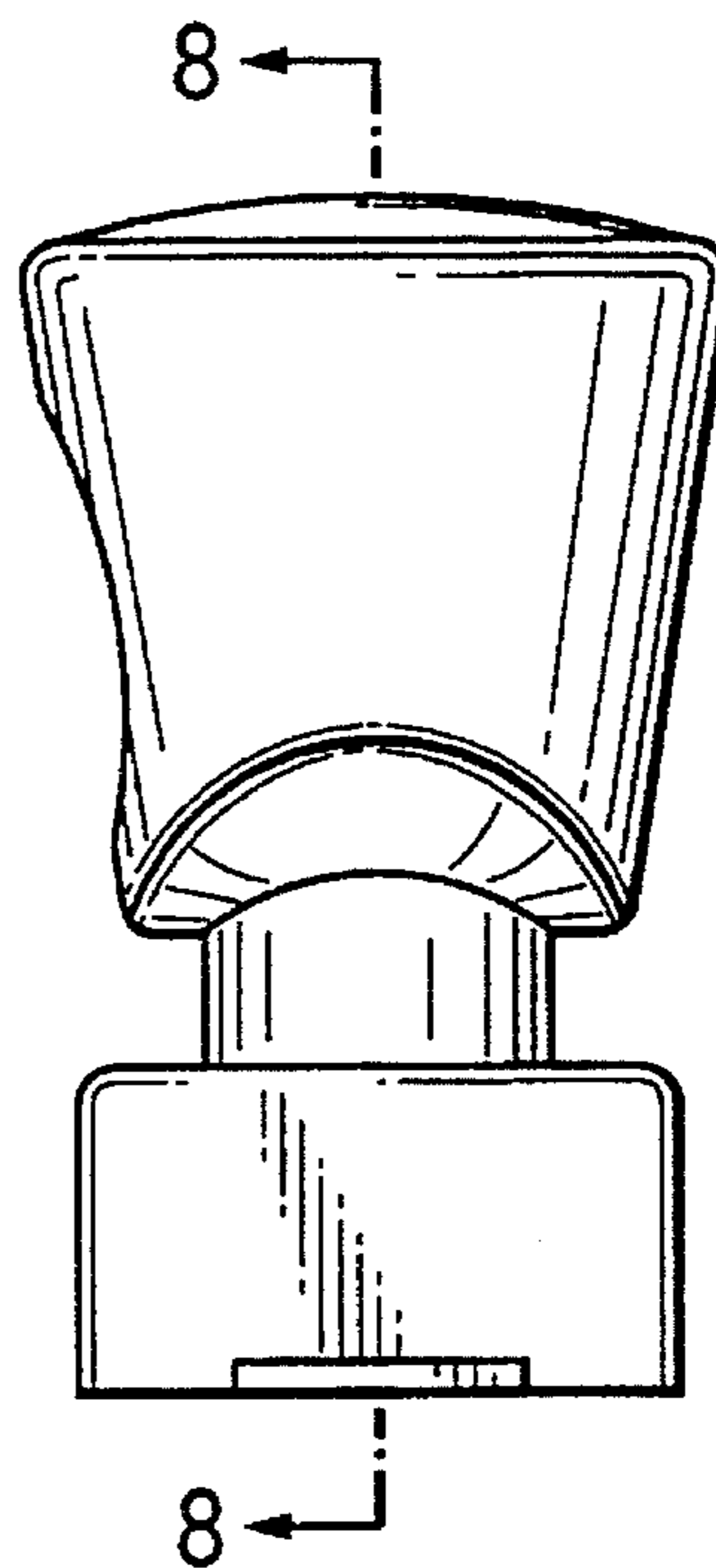

FIG. 5

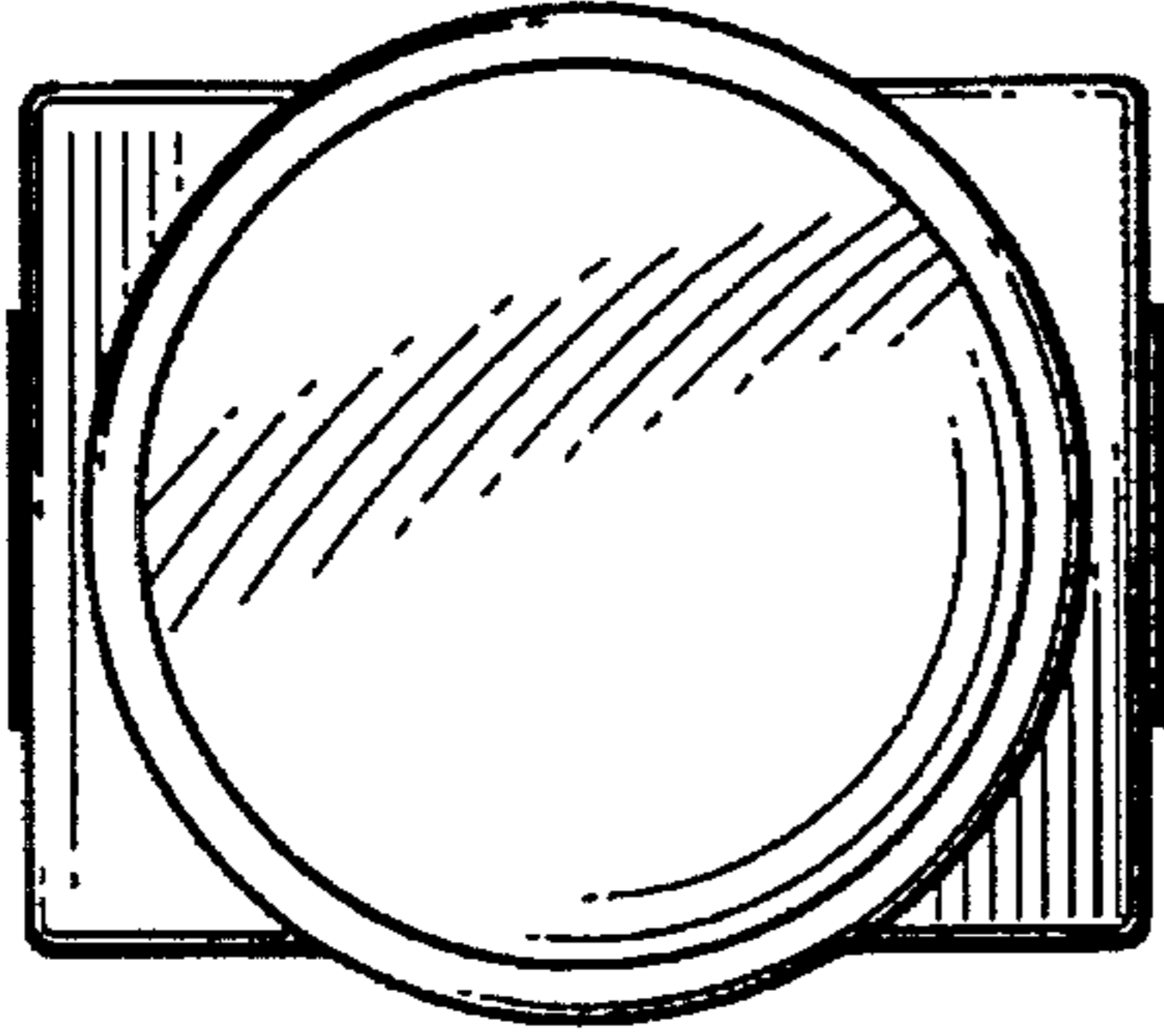

FIG. 6

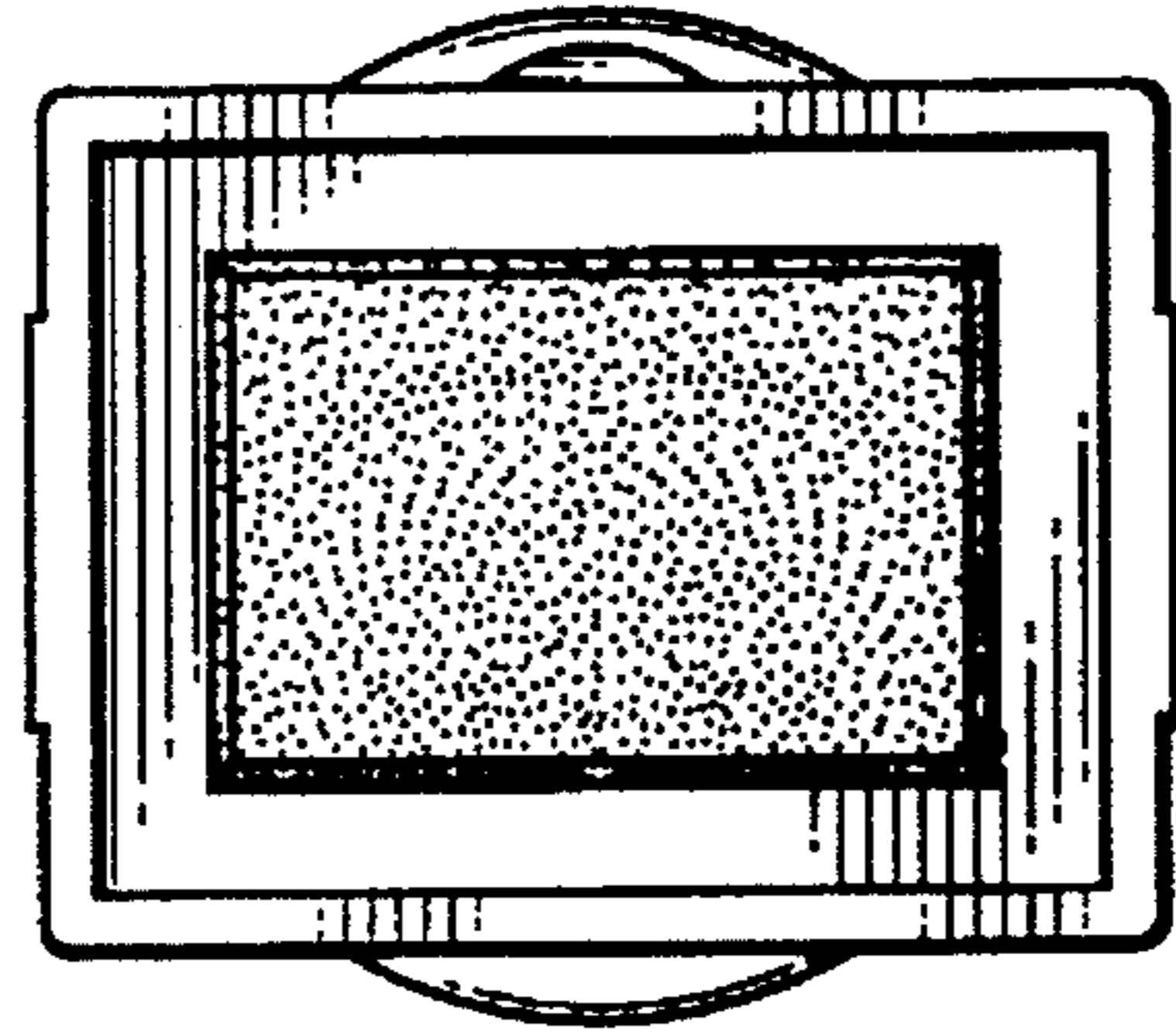

FIG. 7

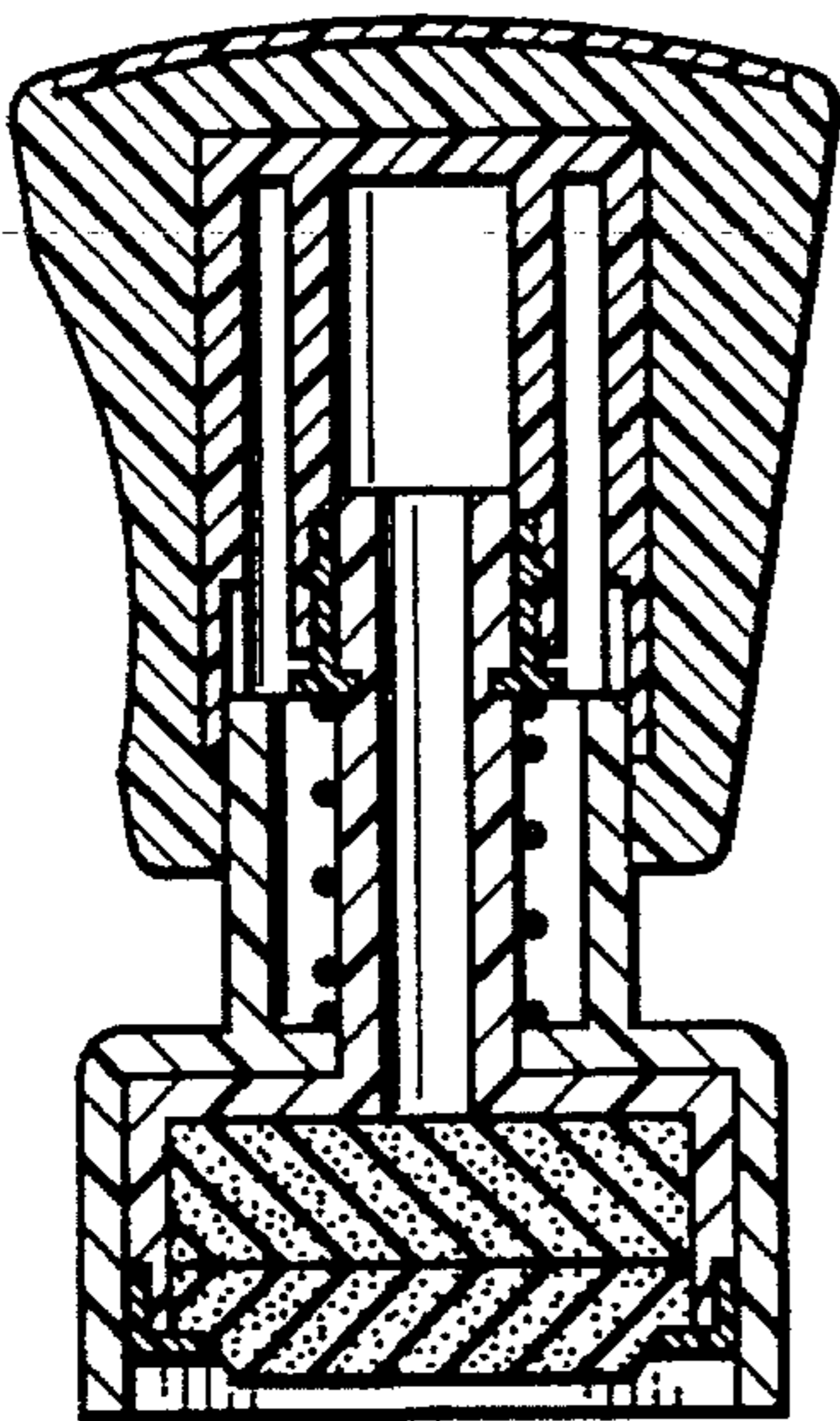

FIG. 8

