



US00D378827S

United States Patent [19]

[11] Patent Number: **Des. 378,827**

Uchiyama

[45] Date of Patent: ****Apr. 15, 1997**

[54] STAMP

[75] Inventor: **Yoichi Uchiyama**, Nagoya, Japan

[73] Assignee: **Brother Kogyo Kabushiki Kaisha**,
Aichi-ken, Japan

[**] Term: **14 Years**

[21] Appl. No.: **33,492**

[22] Filed: **Jan. 13, 1995**

[30] Foreign Application Priority Data

Jul. 13, 1994 [JP] Japan 6-21030

Jul. 13, 1994 [JP] Japan 6-21031

[52] U.S. Cl. **D18/15**

[58] Field of Search D18/18, 16, 15,
D18/17; 118/264, 268; 101/333, 327, 405,
406, 371, 372, 376, 373

[56] References Cited

U.S. PATENT DOCUMENTS

2,891,472	6/1959	Holzer	101/333
3,478,682	11/1969	Funahashi	101/373 X
3,631,799	1/1972	Funahashi	101/327
3,952,653	4/1976	McFarland	101/327
4,392,425	7/1983	Capezuto et al.	101/405
4,432,281	2/1984	Wall et al.	101/327
5,483,880	1/1996	Seo et al.	101/405 X

OTHER PUBLICATIONS

Trodat Company Profile, no page No. given, 1990.

Primary Examiner—Louis S. Zarfes

Assistant Examiner—Frank Martinez

Attorney, Agent, or Firm—Oliff & Berridge

[57] CLAIM

The ornamental design for a stamp, as shown and described.

DESCRIPTION

FIG. 1 is a top plan view of a stamp;
 FIG. 2 is a front view of the stamp;
 FIG. 3 is a bottom plan view of the stamp;
 FIG. 4 is a left side view of the stamp;
 FIG. 5 is a right side view of the stamp;
 FIG. 6 is a rear view of the stamp;
 FIG. 7 is a perspective view of the stamp;
 FIG. 8 is a perspective view of the stamp, with a cover member thereof being removed;
 FIG. 9 is a top plan view of a stamp;
 FIG. 10 is a front view of the stamp;
 FIG. 11 is a bottom plan view of the stamp;
 FIG. 12 is a left side view of the stamp;
 FIG. 13 is a right side view of the stamp;
 FIG. 14 is a rear view of the stamp;
 FIG. 15 is a perspective view of the stamp; and,
 FIG. 16 is a perspective view of the stamp, with a cover member thereof being removed.

1 Claim, 8 Drawing Sheets

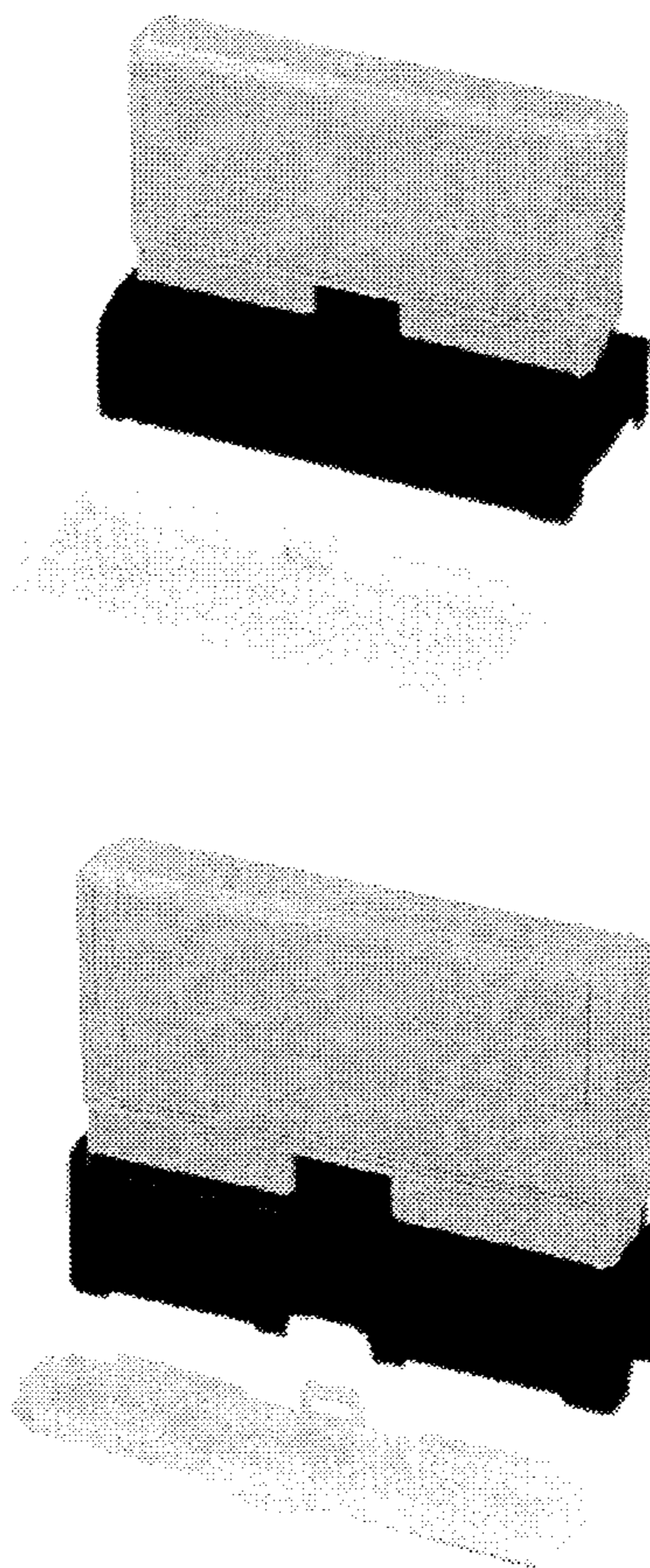

FIG 1

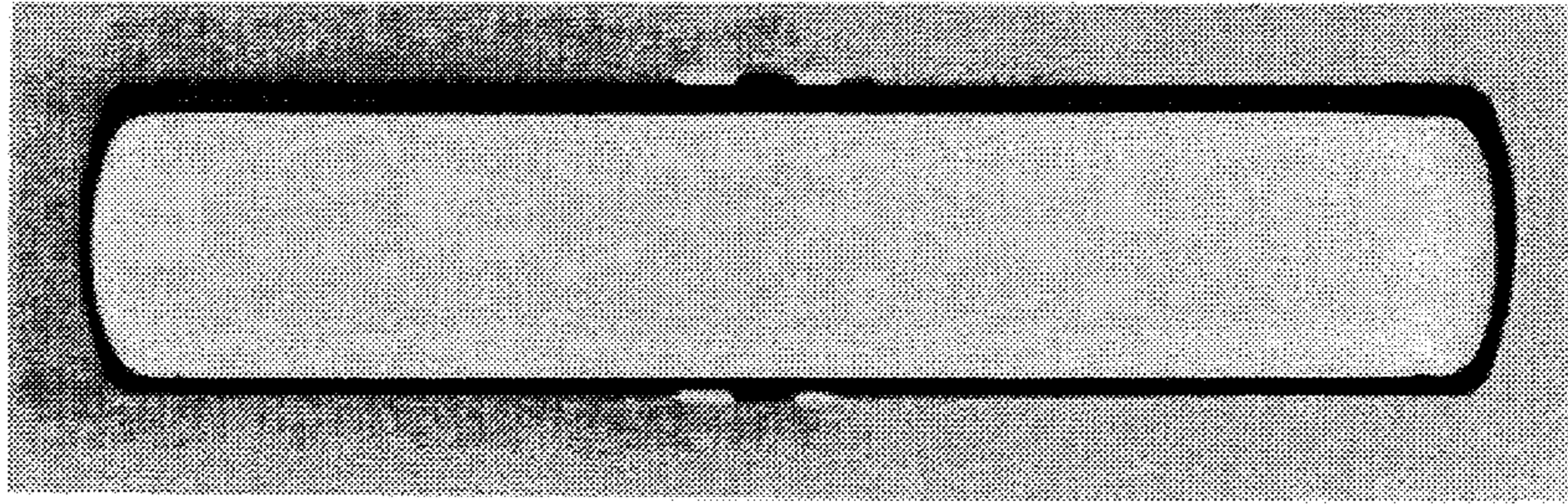

FIG 2

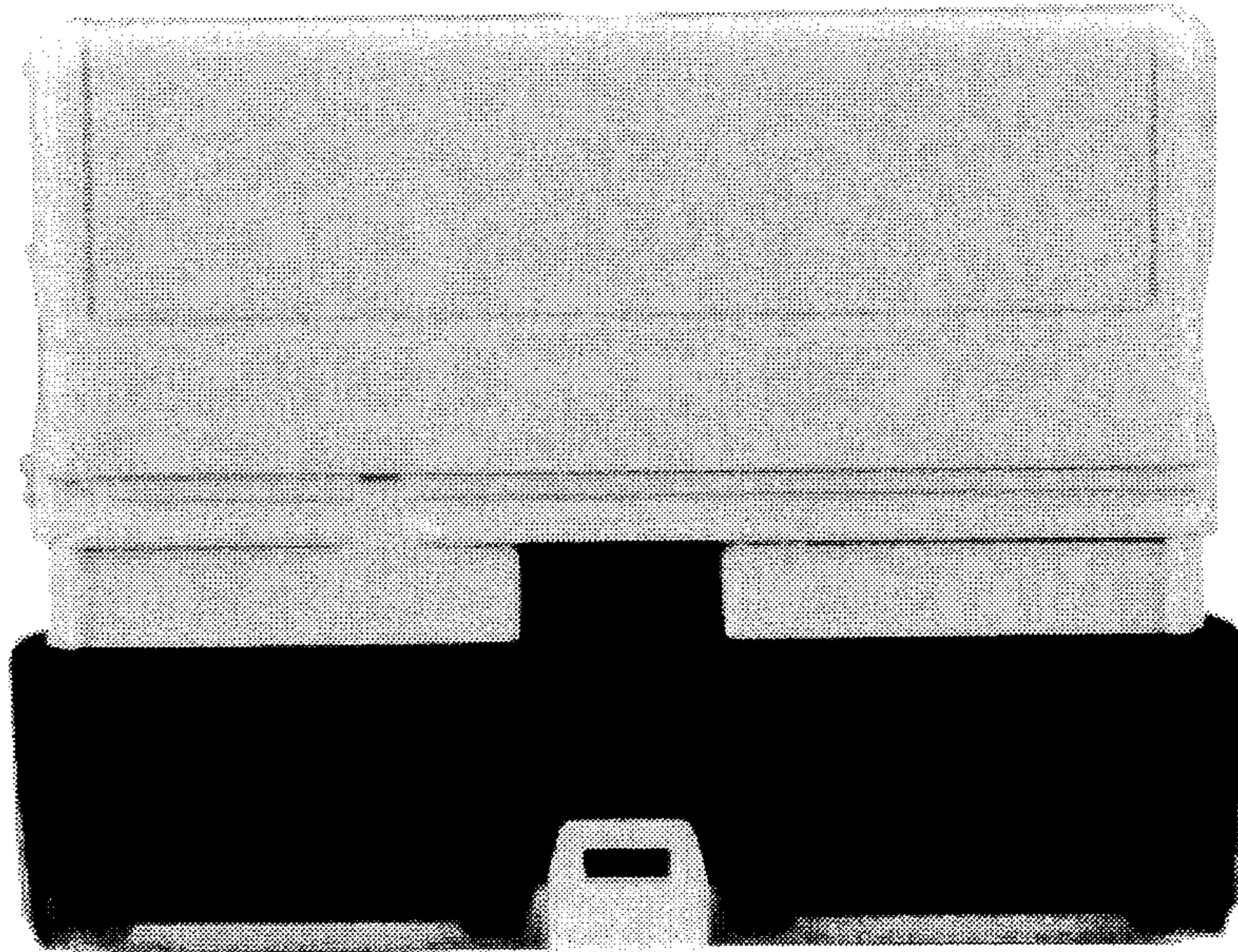

FIG 3

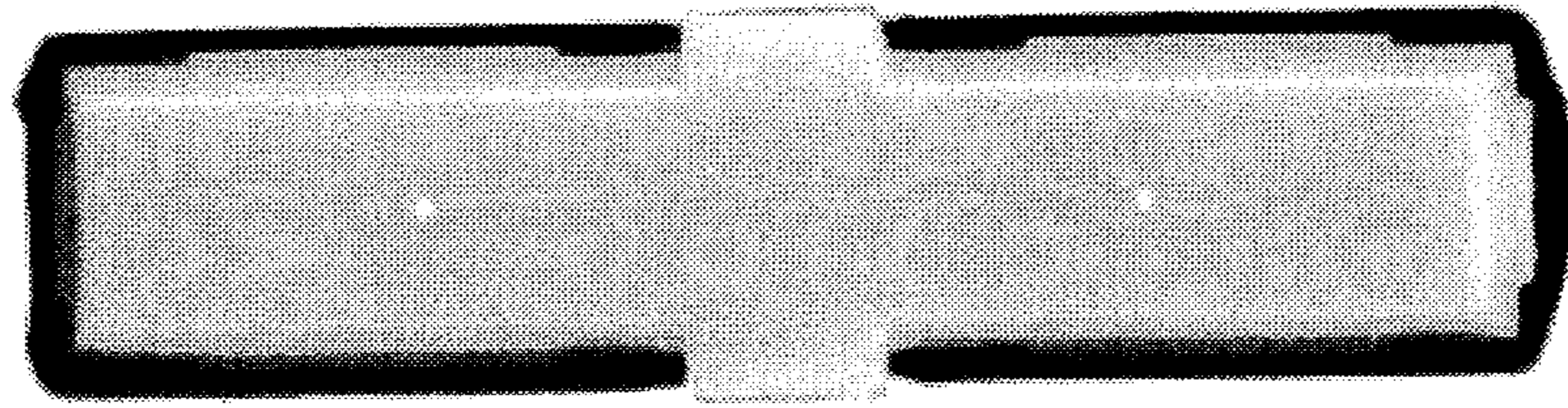

FIG 4

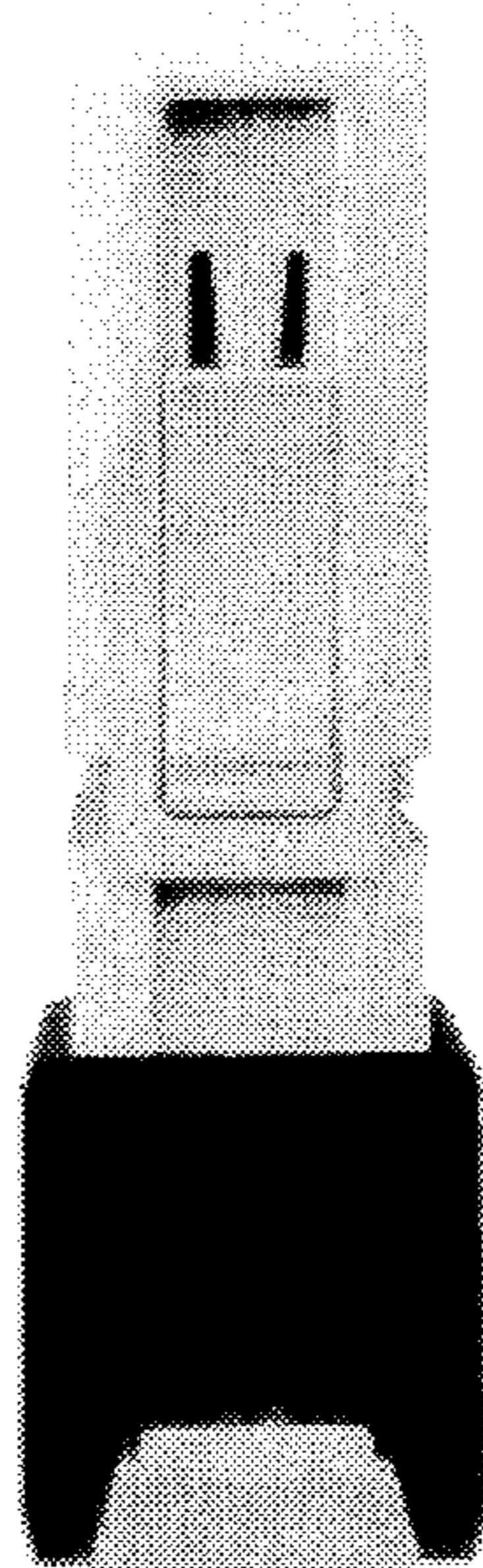

FIG 5

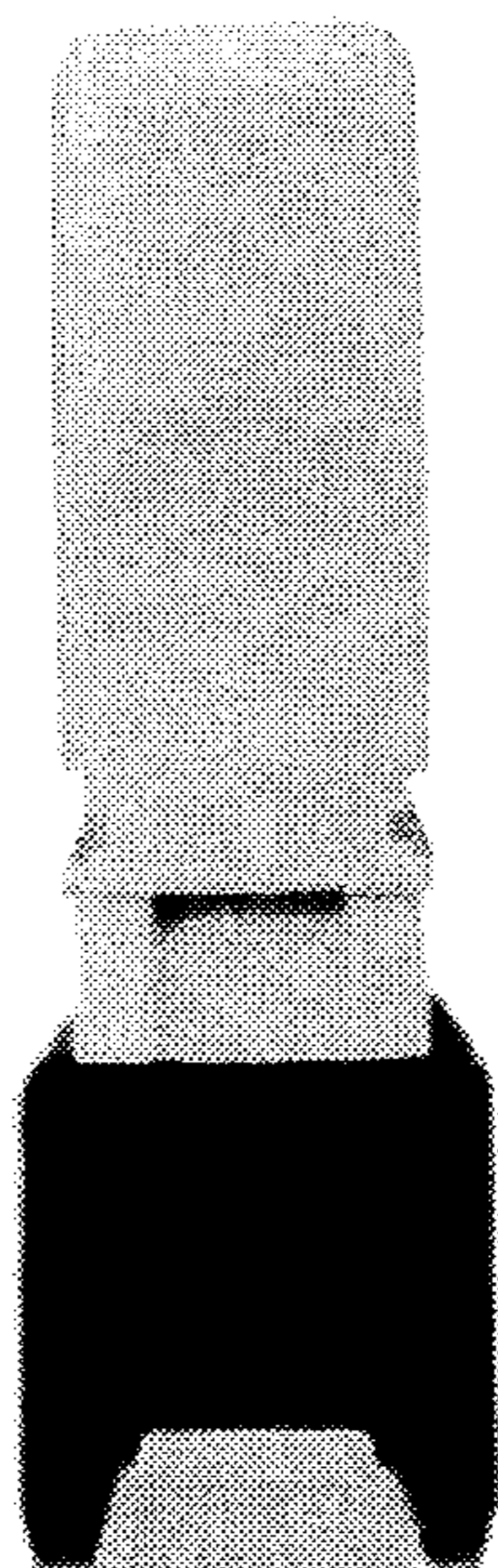

FIG 6

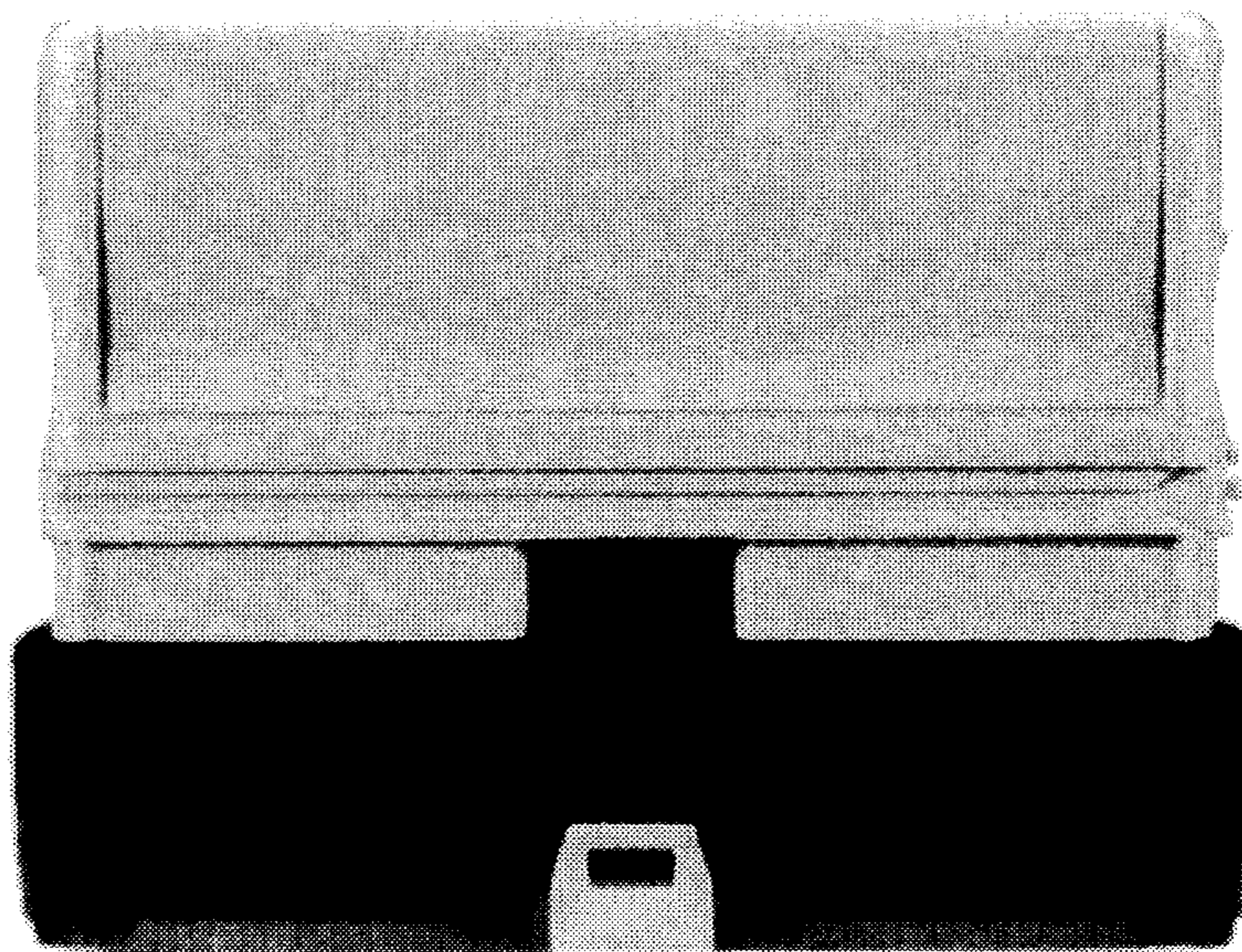

FIG 7

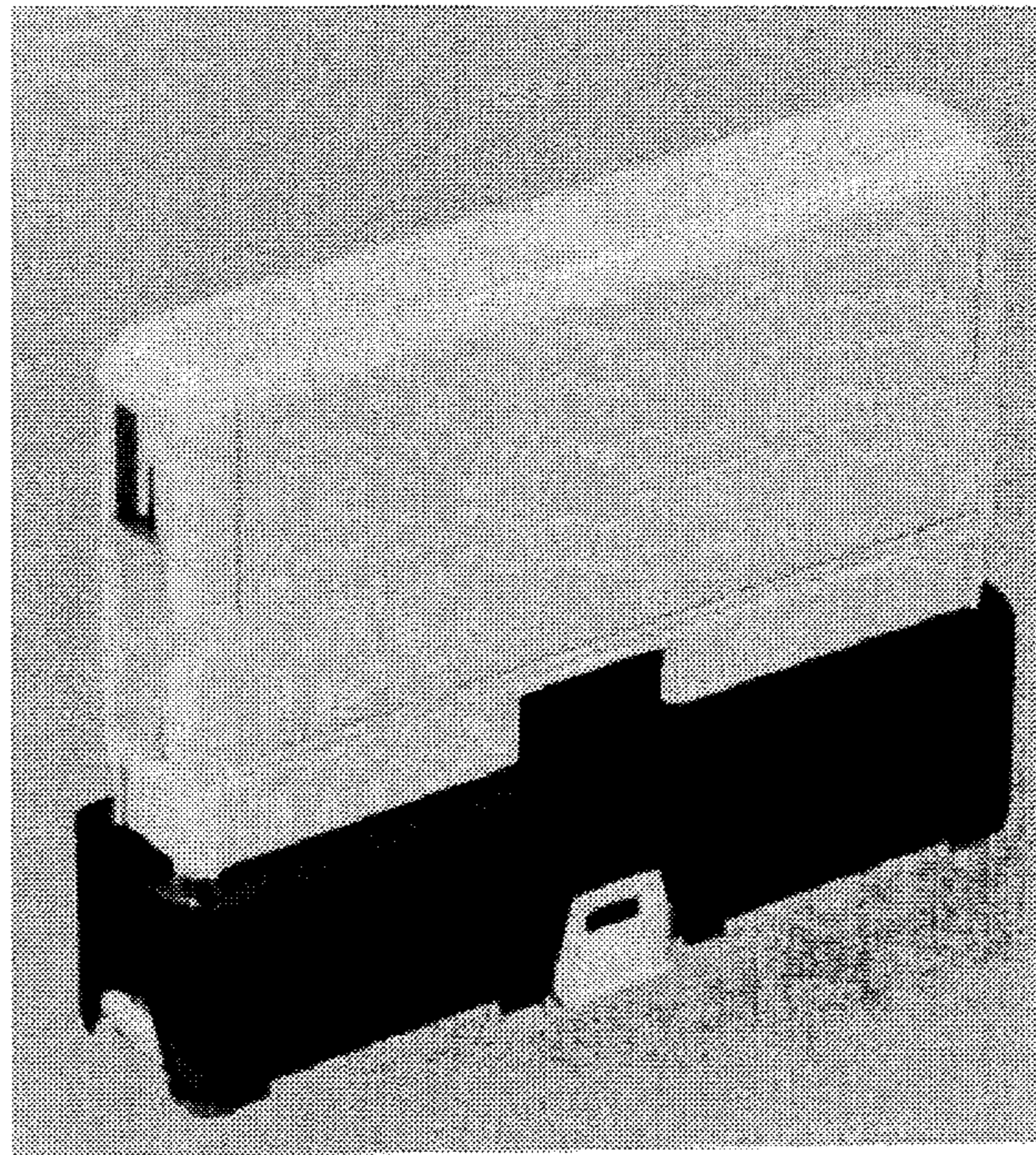

FIG 8

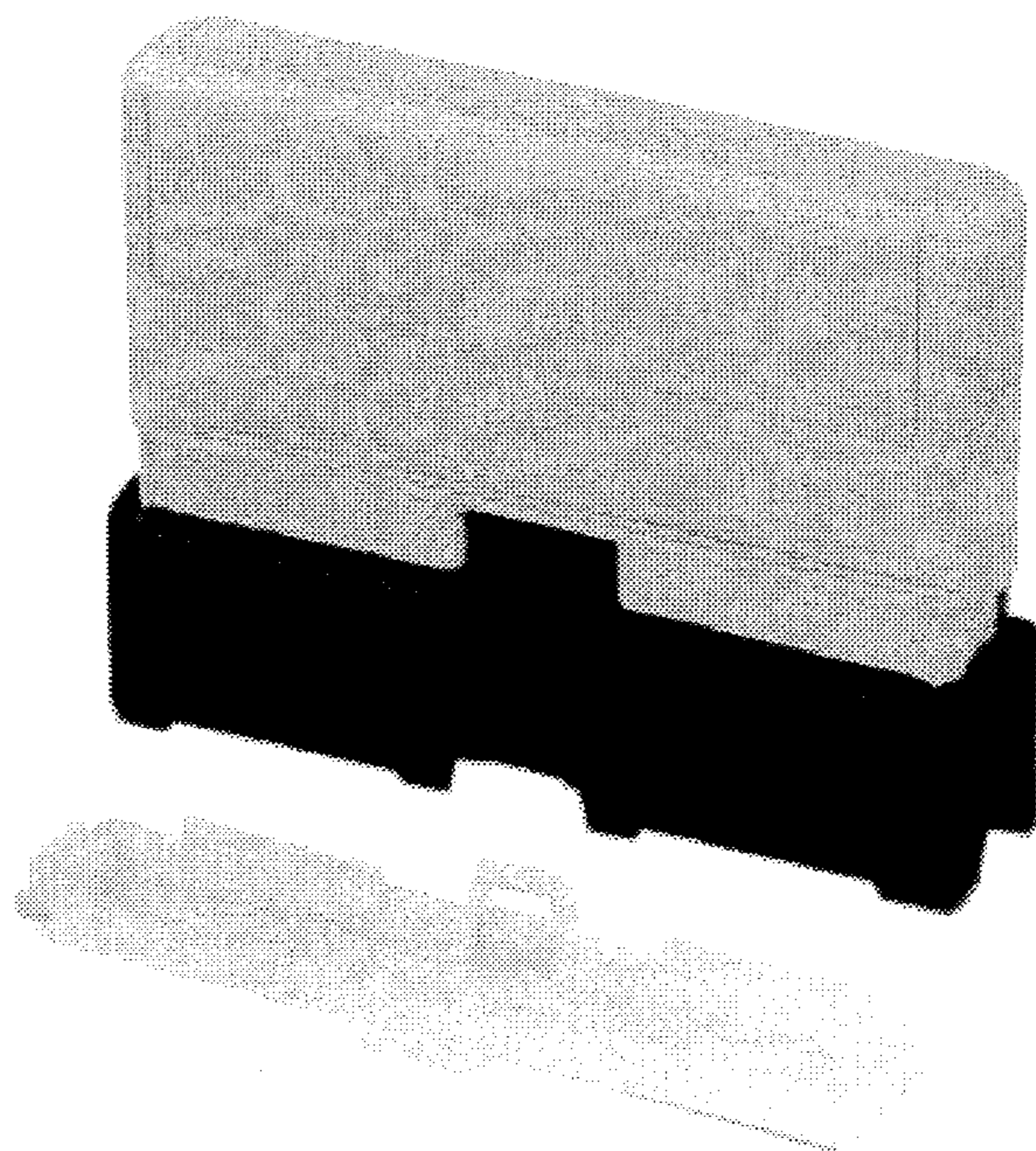

FIG 9

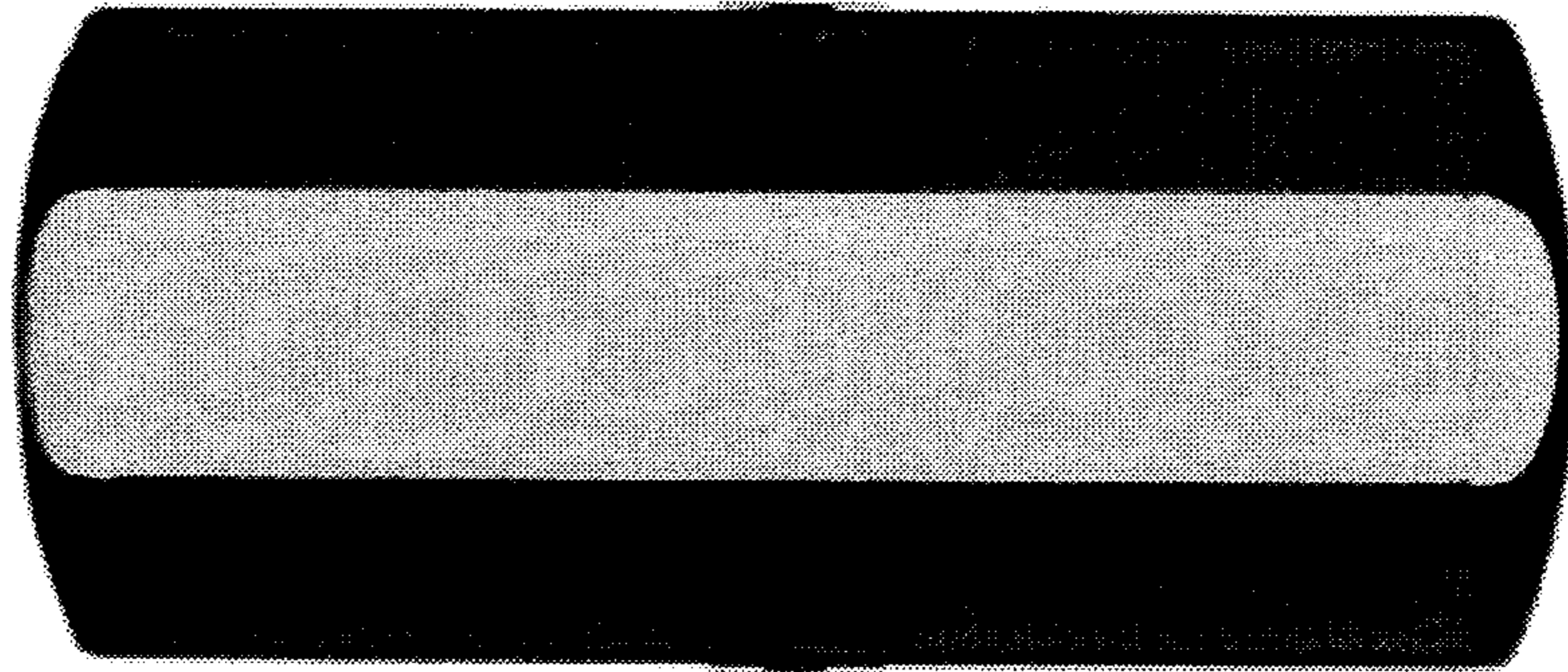

FIG 10

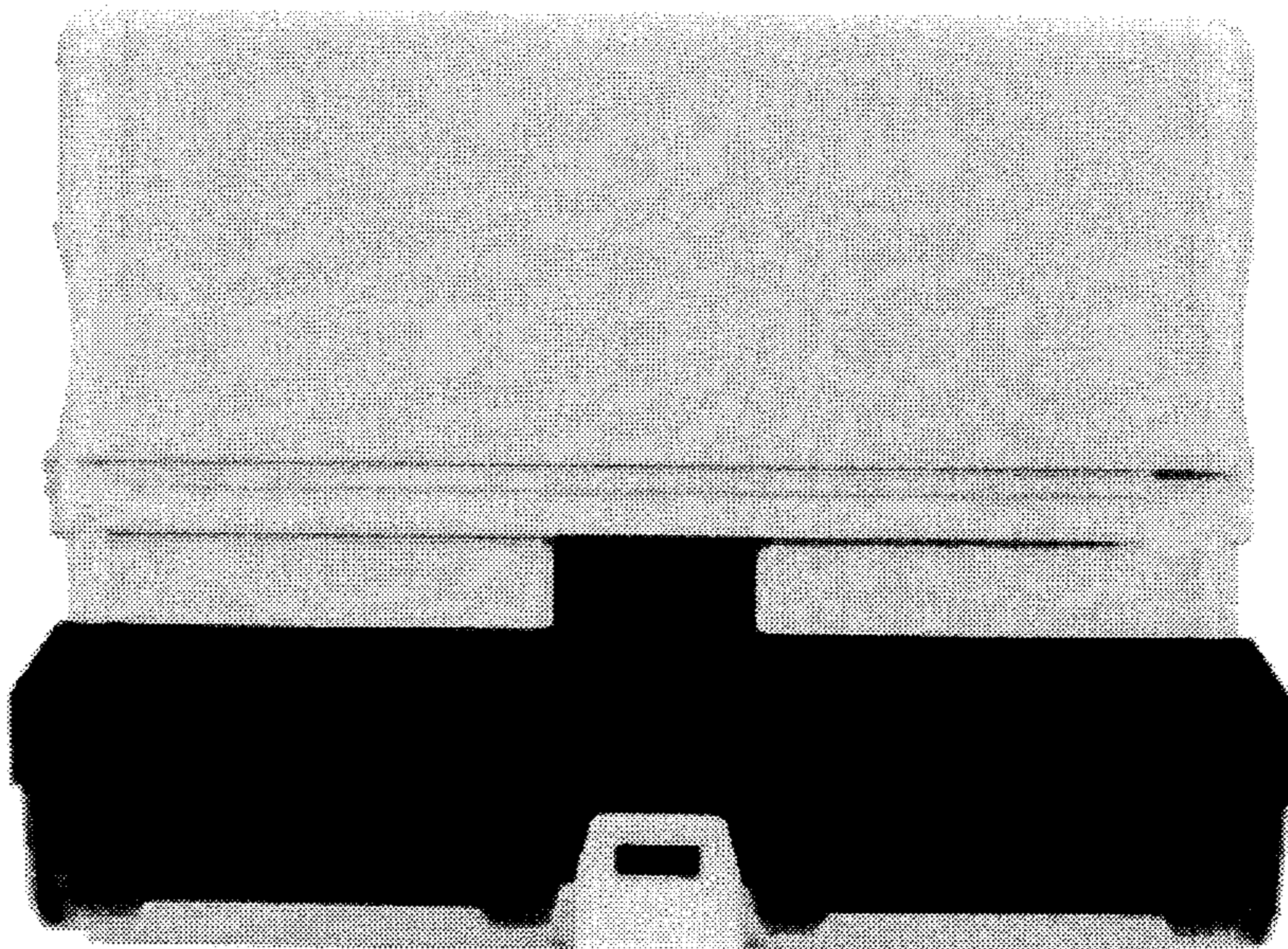

FIG 11

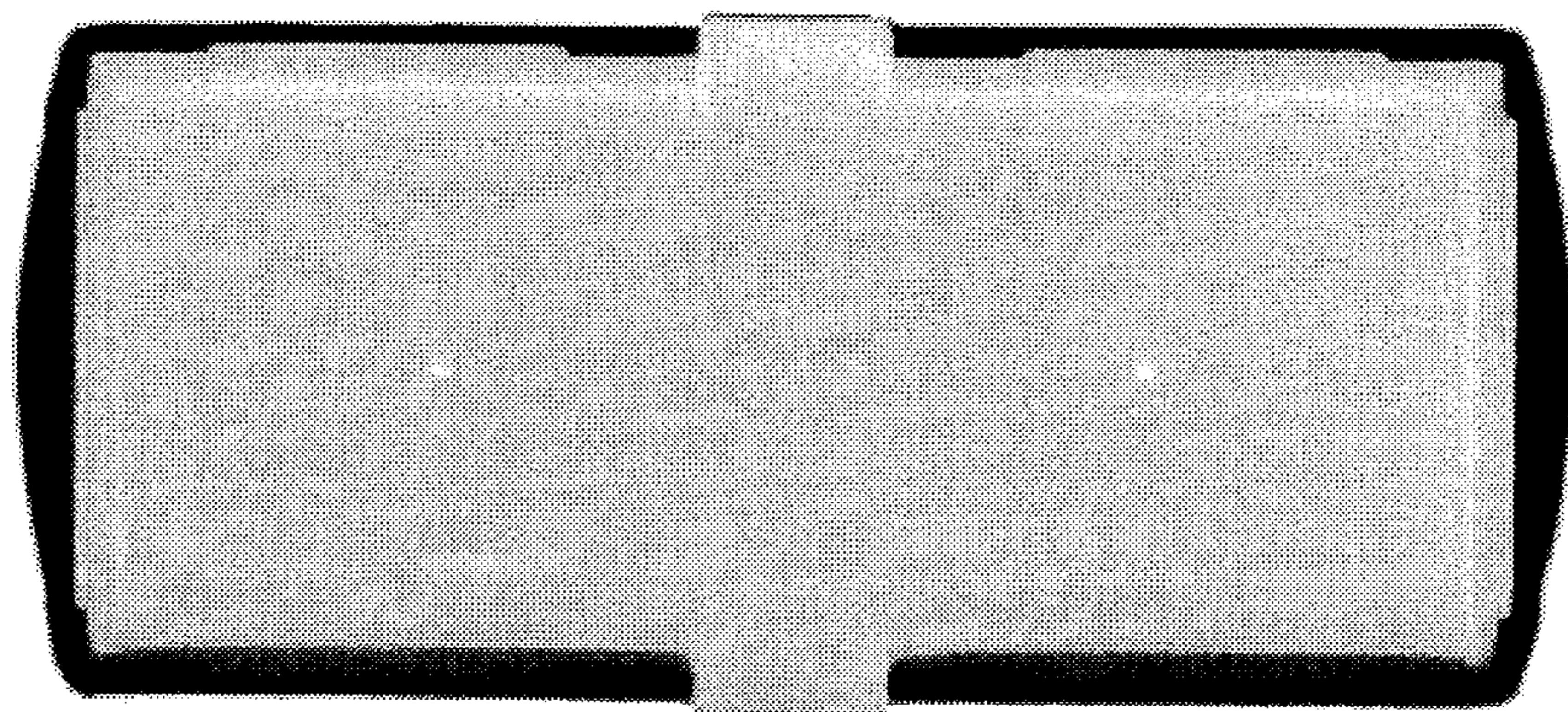

FIG 12

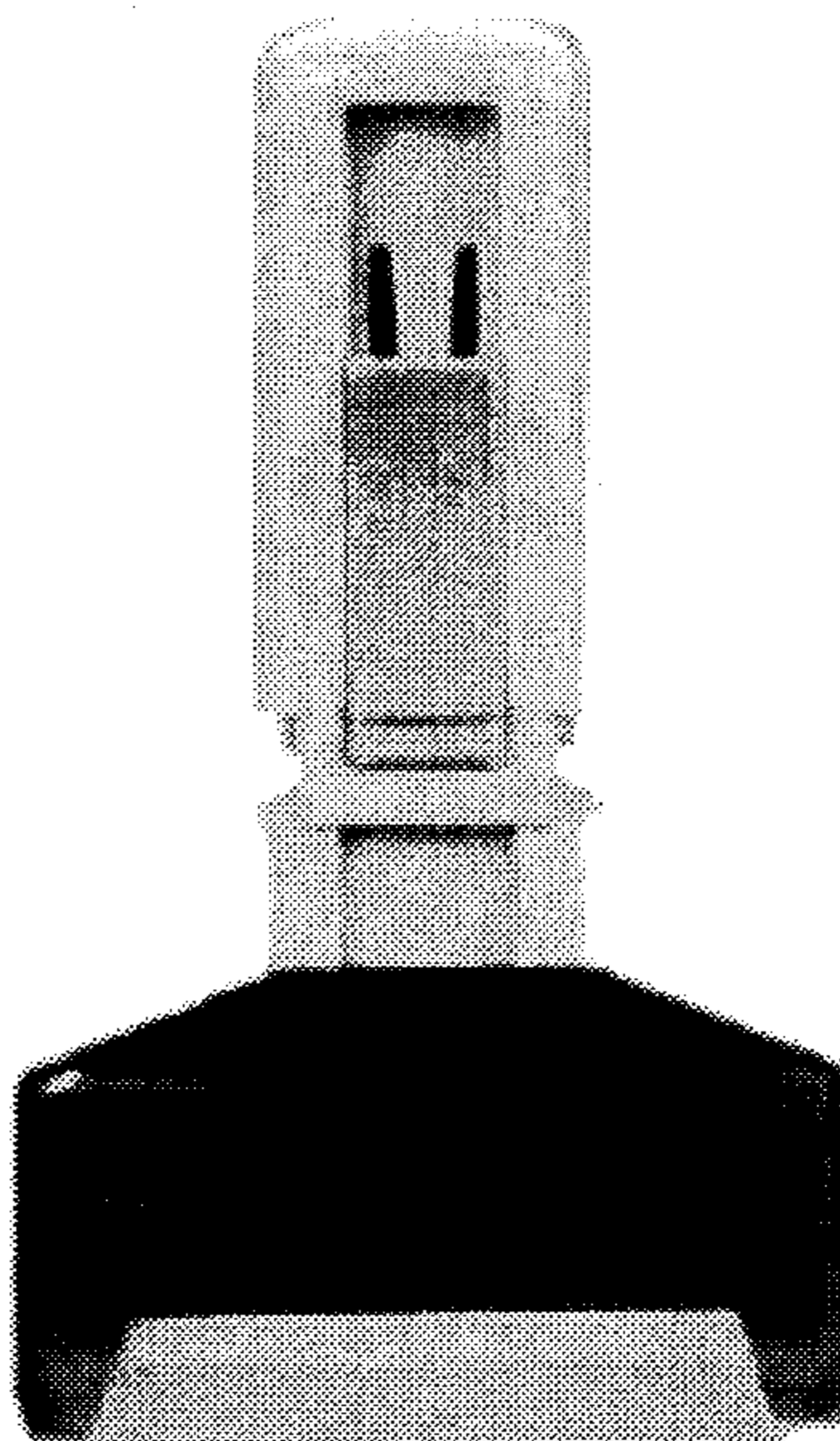

FIG 13

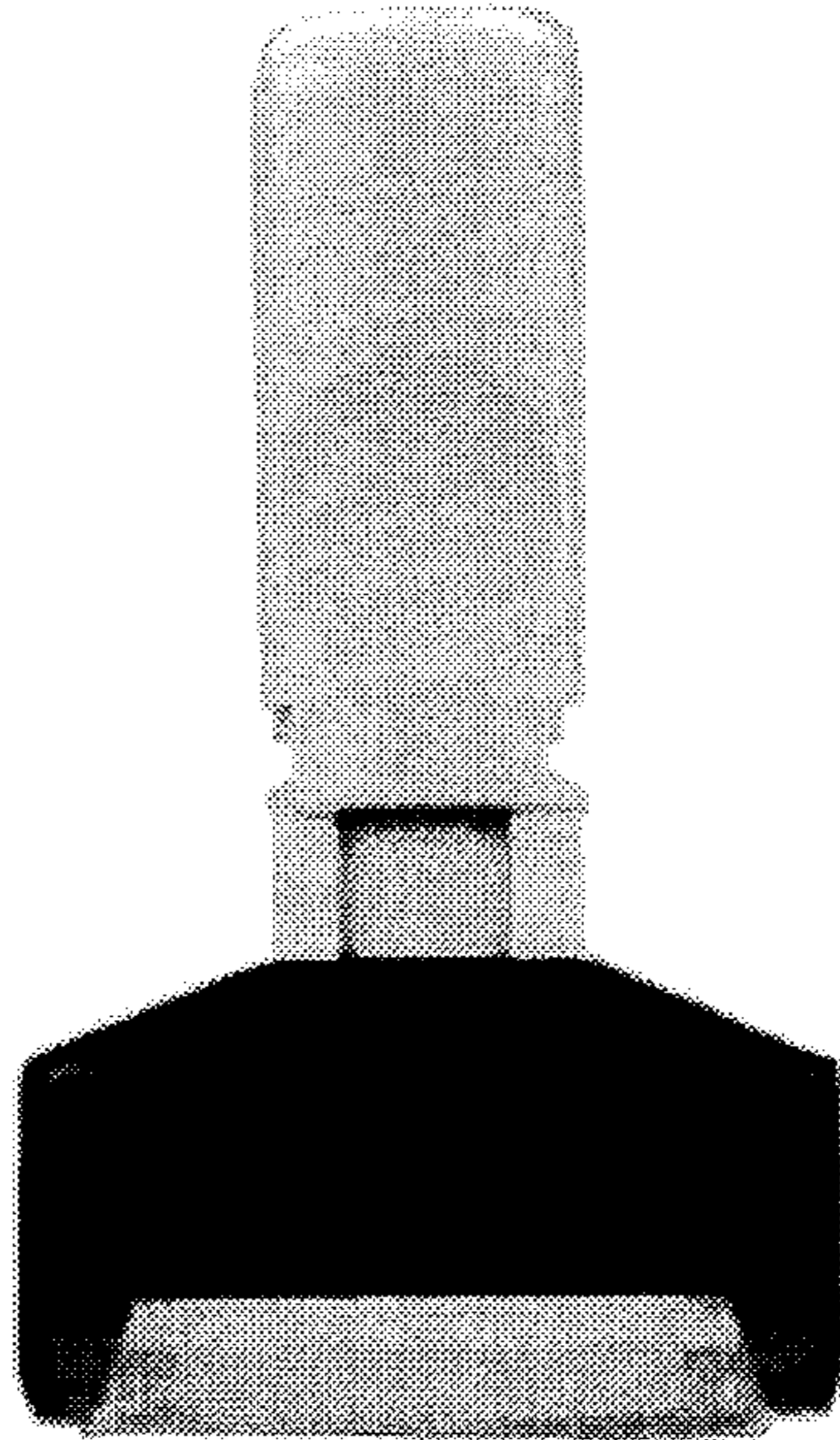

FIG 14

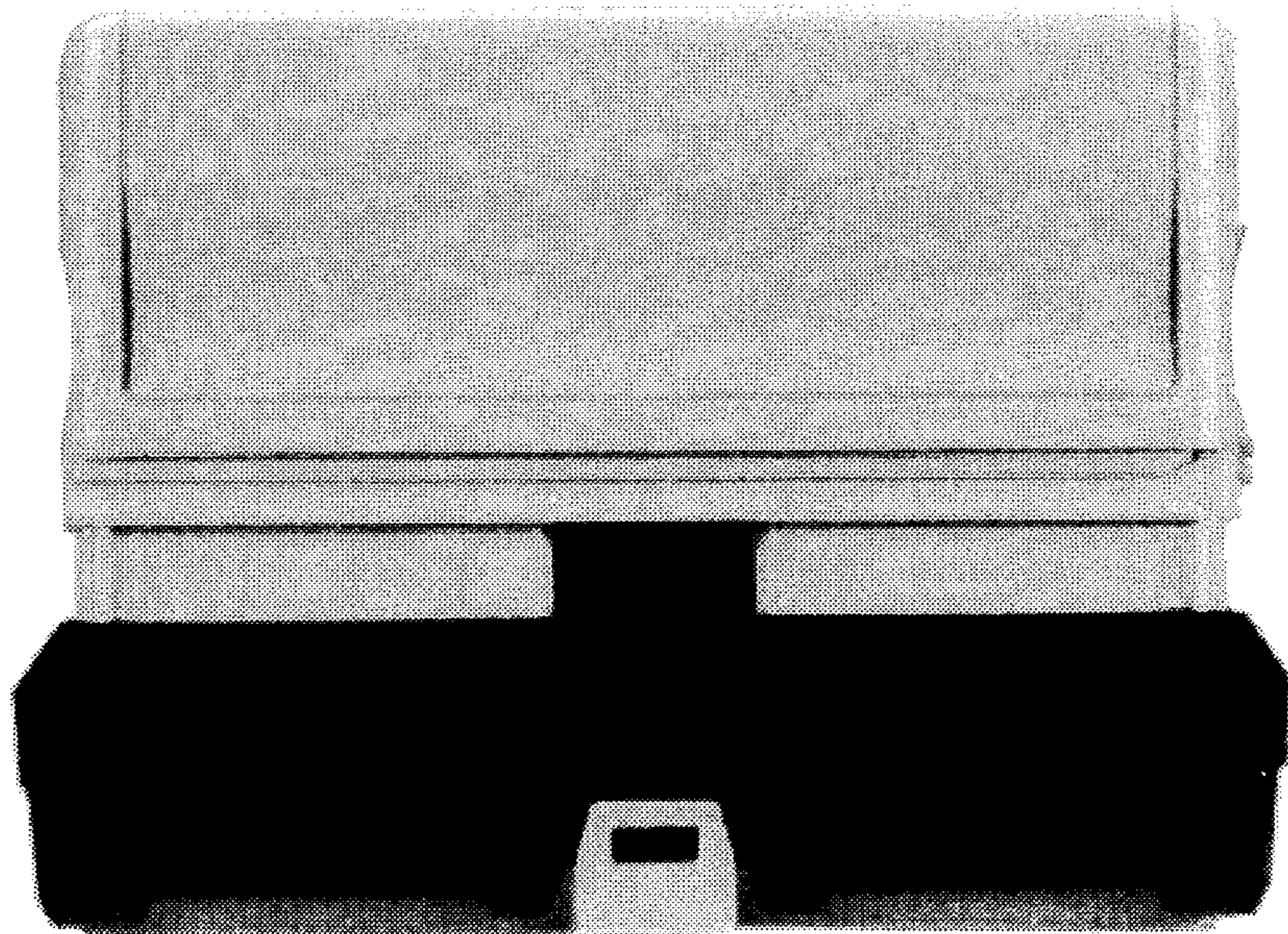

FIG 15

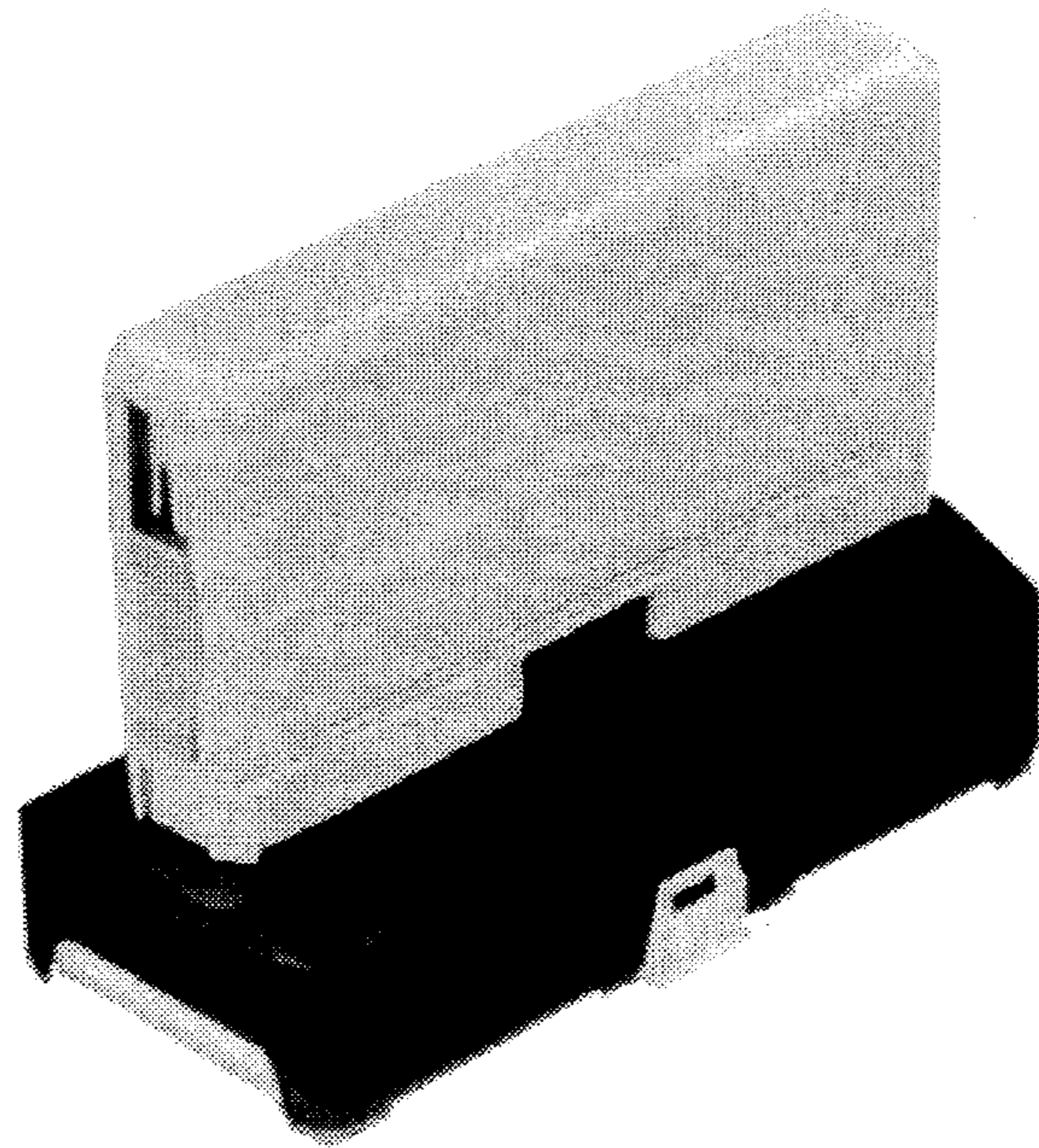

FIG 16

