



US00D378820S

United States Patent [19]

[11] Patent Number: **Des. 378,820**

Tokiyama et al.

[45] Date of Patent: ****Apr. 15, 1997**

[54] **MOBILE MICROPHONE**

2,611,042 9/1952 De Napoli, Jr. 381/168
4,057,124 11/1977 Braden 381/168 X

[75] Inventors: **Masaru Tokiyama**, Coral Springs;
Jerry R. Nichols, Margate, both of Fla.

Primary Examiner—Sandra L. Morris
Assistant Examiner—Nanda Bondade
Attorney, Agent, or Firm—M. Mansour Ghomeshi

[73] Assignee: **Motorola, Inc.**, Schaumburg, Ill.

[**] Term: **14 Years**

[57] **CLAIM**

[21] Appl. No.: **38,243**

The ornamental design for a mobile microphone, as shown and described.

[22] Filed: **May 1, 1995**

DESCRIPTION

[52] U.S. Cl. **D14/225**

[58] **Field of Search** D14/205–206,
D14/223–229, 299; 181/158, 242; 379/368,
430–431; 381/91, 122, 153, 168, 169, 183

FIG. 1 is a front elevational view of a mobile microphone showing our new design;
FIG. 2 is a back side elevational view thereof;
FIG. 3 is a left side elevational view thereof;
FIG. 4 is a right side elevational view thereof;
FIG. 5 is a top plan view thereof;
FIG. 6 is a bottom plan view thereof; and,
FIG. 7 is an isometric view thereof.

[56] **References Cited**

U.S. PATENT DOCUMENTS

- D. 247,668 4/1978 Furst et al. .
- D. 281,419 11/1985 Nagele .
- 2,554,113 5/1951 McCreary 381/169 X
- 2,561,320 7/1951 Stone et al. 381/91

1 Claim, 4 Drawing Sheets

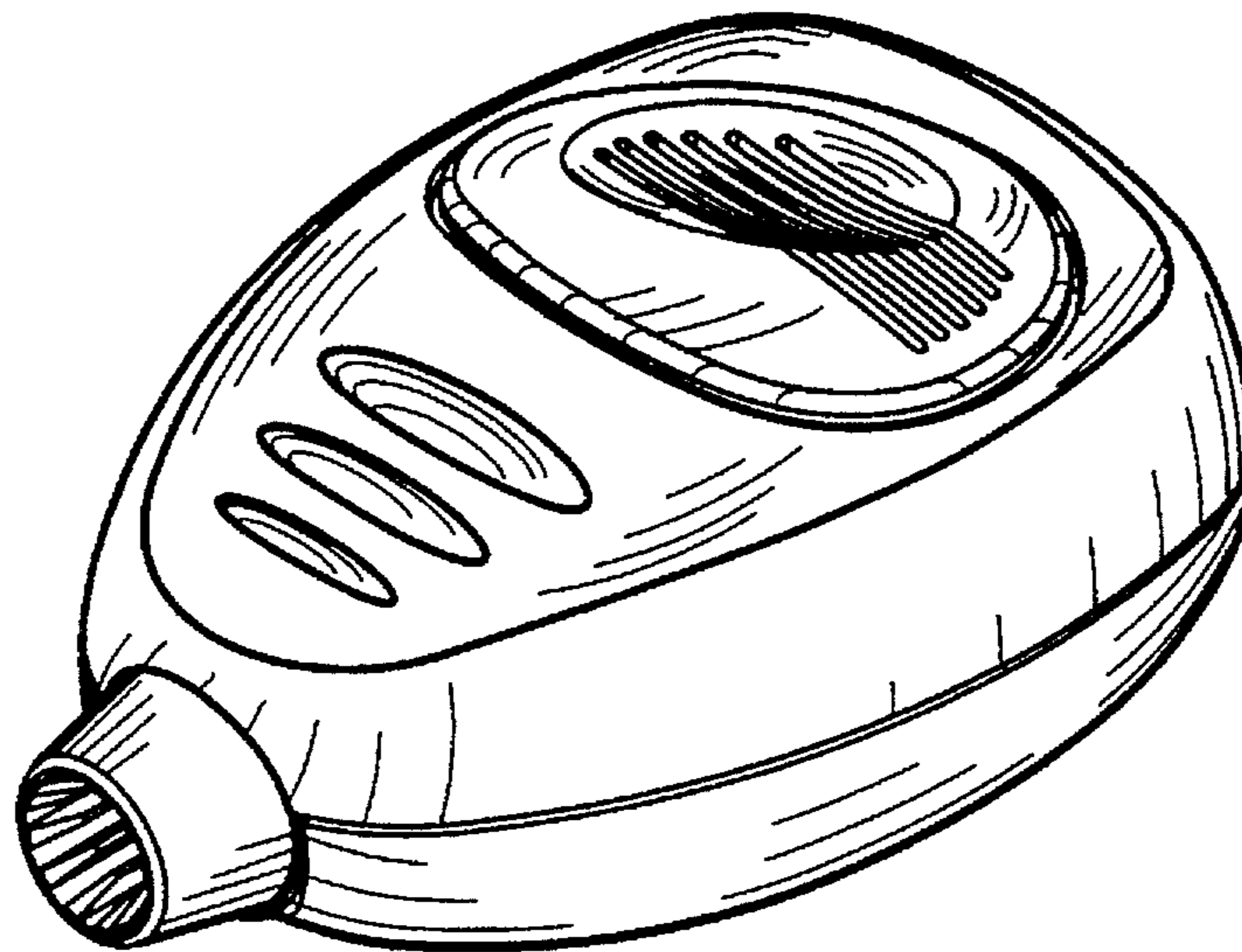

FIG. 2

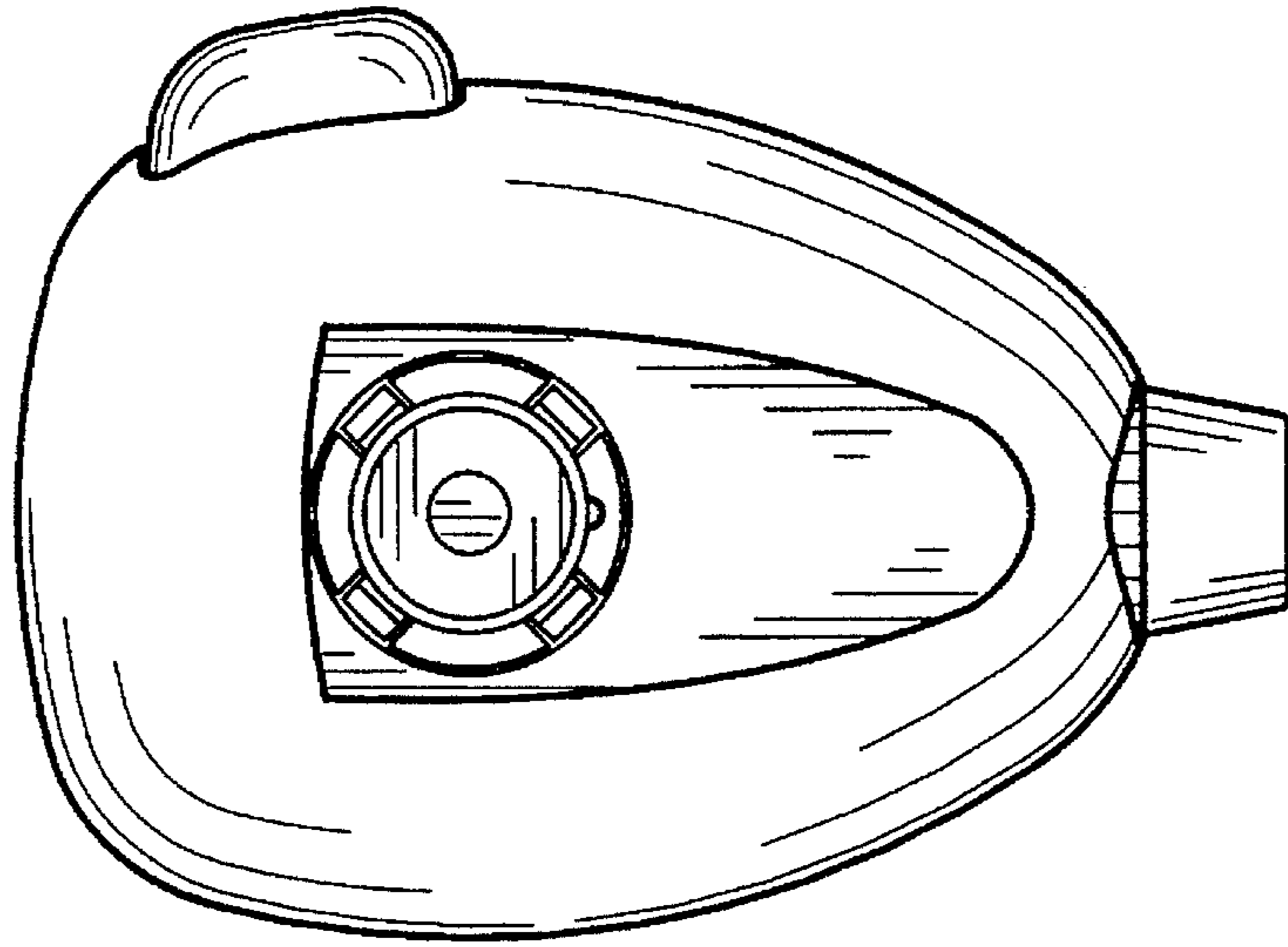

FIG. 1

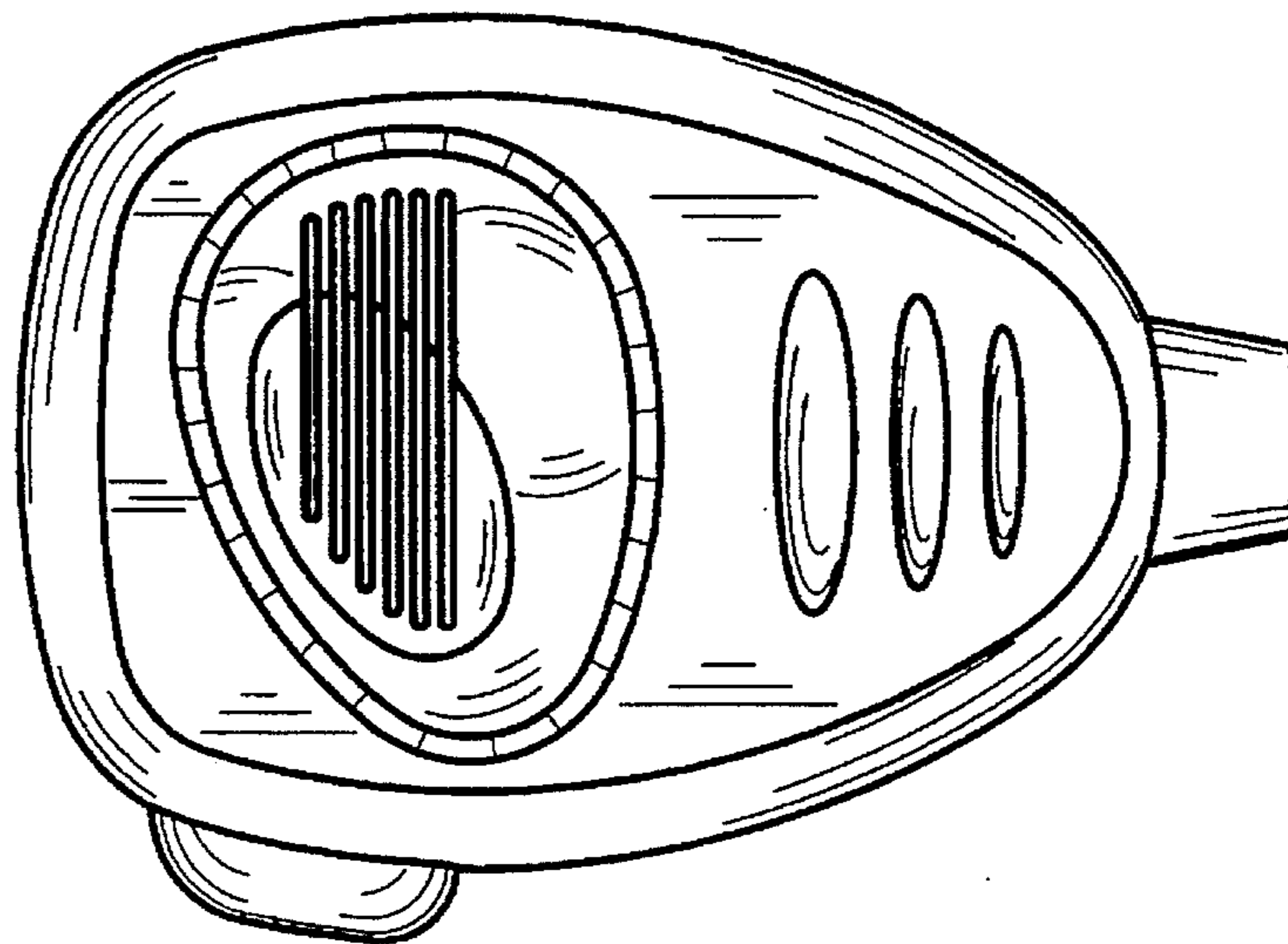

FIG. 4

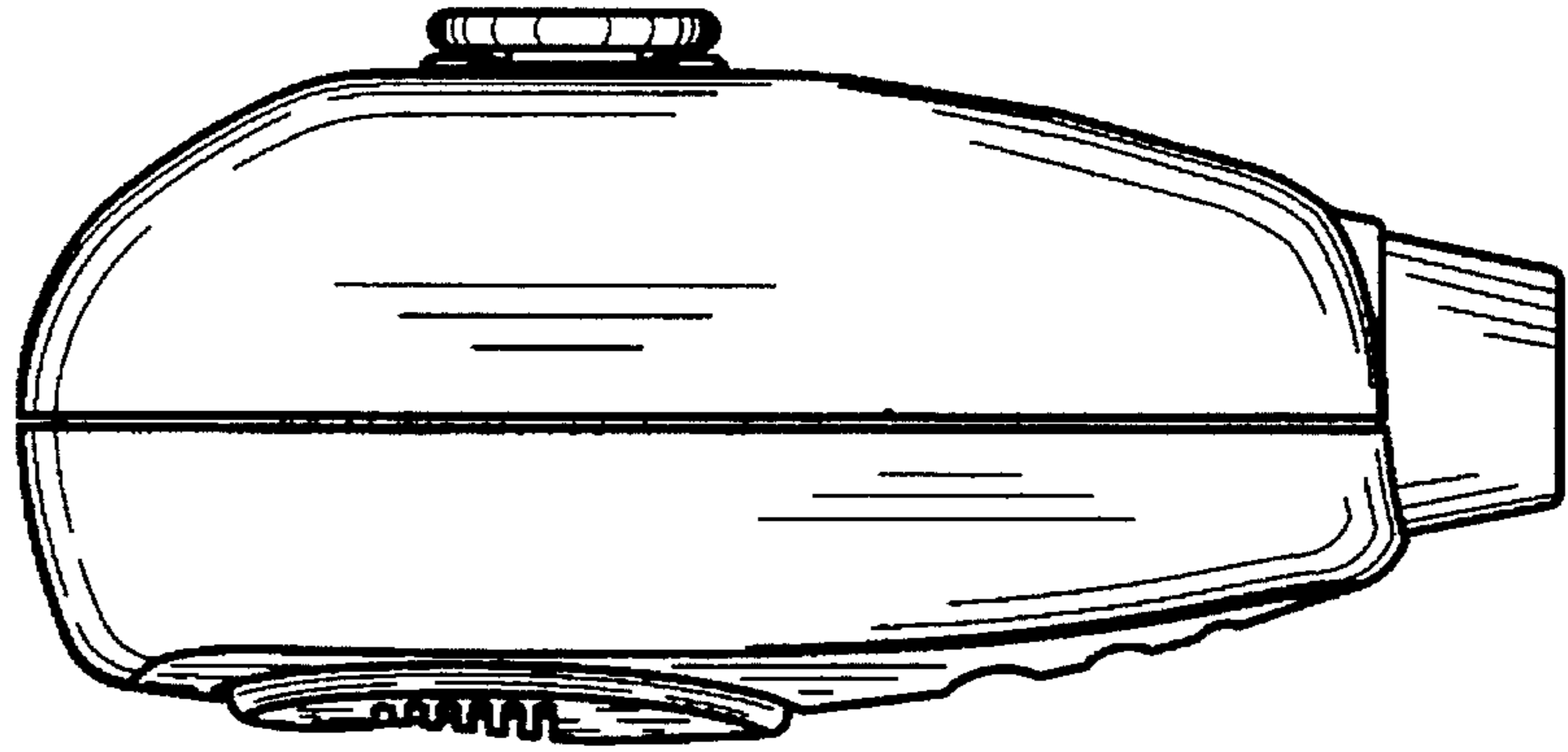

FIG. 3

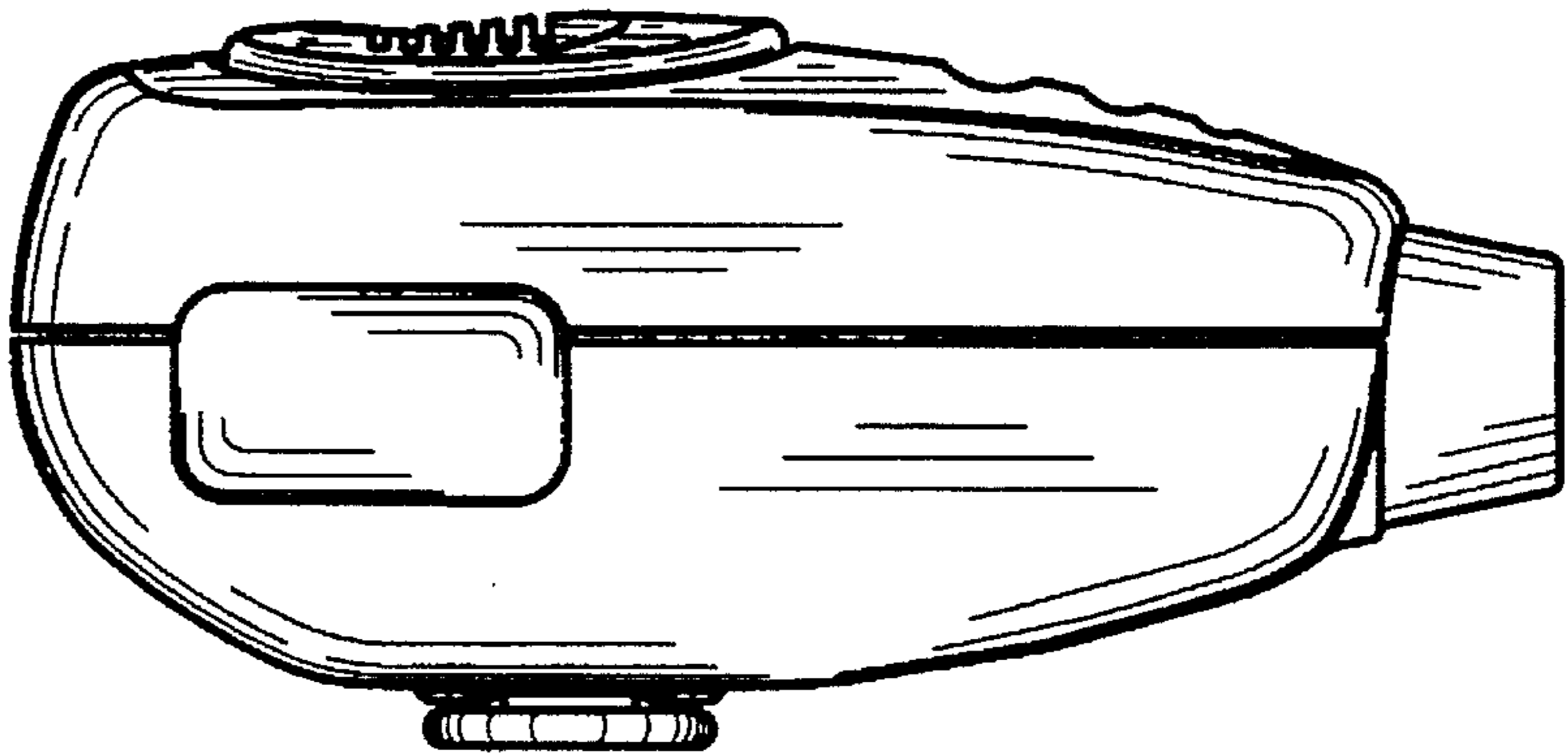

FIG. 6

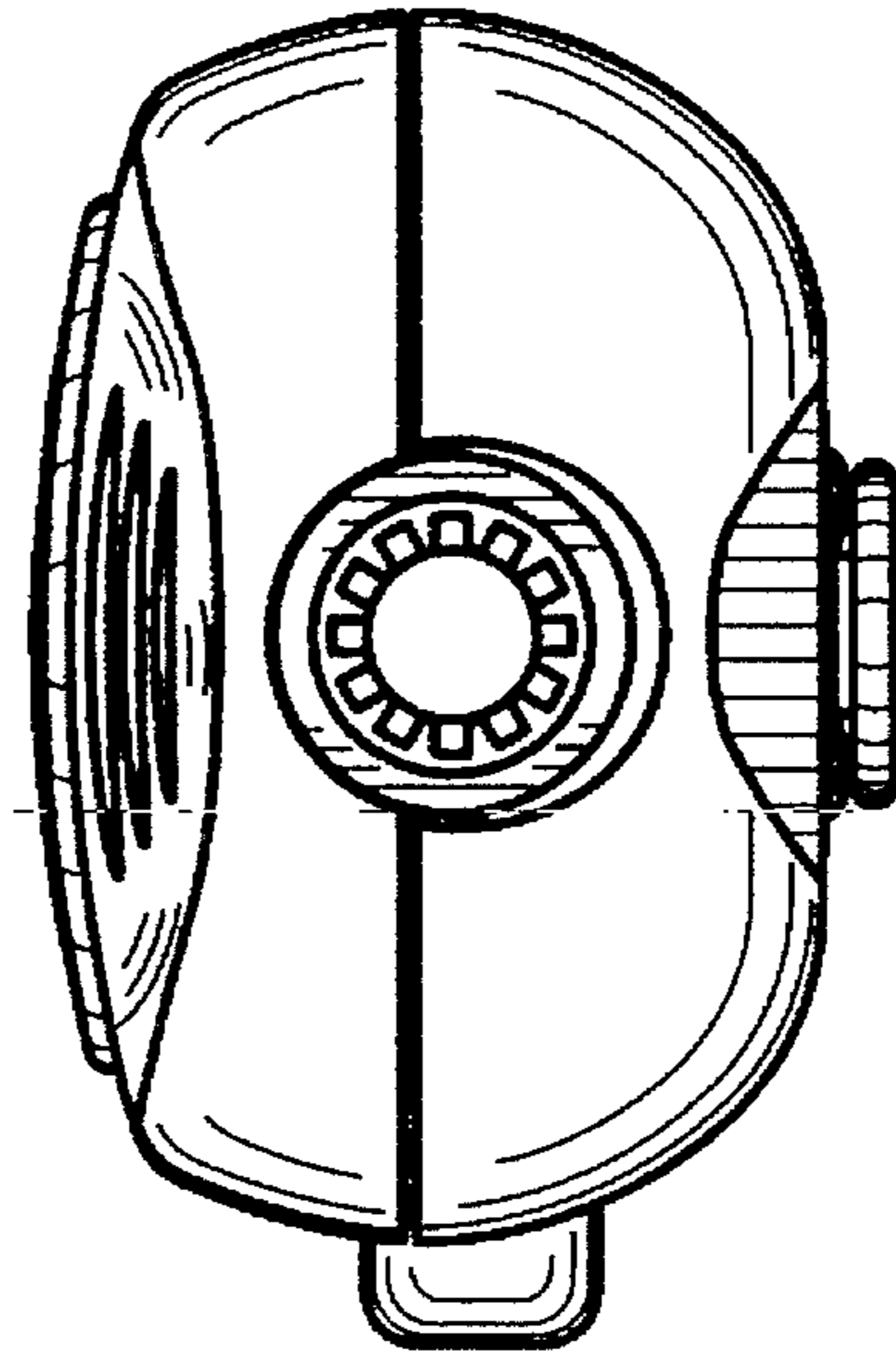

FIG. 5

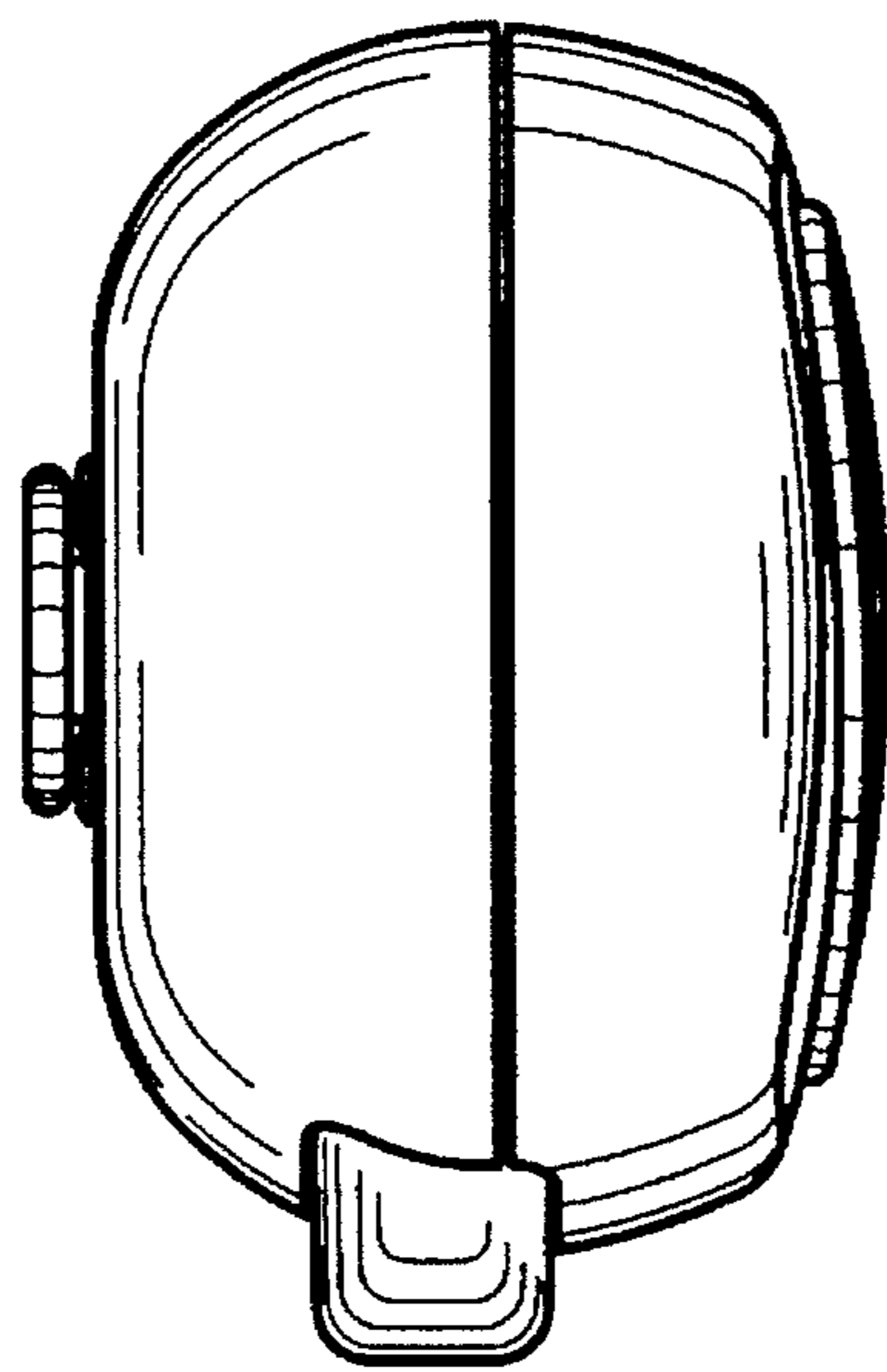

FIG. 7

