



US00D378695S

United States Patent [19]

[11] Patent Number: **Des. 378,695**

Mathison et al.

[45] Date of Patent: ****Apr. 1, 1997**

[54] PIPELINE PLUG

[75] Inventors: **Allen D. Mathison**, Richfield; **Randy D. Smith**, New Hope, both of Minn.

[73] Assignee: **Cherne Industries Incorporated**, Minneapolis, Minn.

[**] Term: **14 Years**

[21] Appl. No.: **23,217**

[22] Filed: **May 19, 1994**

[52] U.S. Cl. **D23/260**

[58] Field of Search D23/259, 260; 138/93; 206/522; 383/3; D6/601

[56] References Cited

U.S. PATENT DOCUMENTS

D. 339,949	10/1993	Wei et al.	D6/601
D. 339,950	10/1993	Jung	D6/601
414,748	11/1889	Bentley	D6/601 X
754,329	3/1904	Milliken	D6/601 X
1,349,072	8/1920	Lines	D6/601 X
1,760,750	4/1928	Goodman .	
3,276,481	8/1964	McNulty	138/93
3,414,140	8/1966	Feldkamp	214/10.5
4,492,095	1/1985	Brister	138/93 X
4,612,961	9/1986	Vetter	138/89 X
4,627,470	12/1986	Carruthers	383/3 X
5,240,031	8/1993	Vigil	138/93 X

OTHER PUBLICATIONS

Cherne Industries Incorporated, *Cherne Single-Size Test-Ball Plug*, 1992, Product sheet, 1 page.

Primary Examiner—Louis S. Zarfaz

Assistant Examiner—Eric Watterson

Attorney, Agent, or Firm—Anthony G. Eggink

[57] CLAIM

The ornamental design for the pipeline plug, as shown and described.

DESCRIPTION

FIG. 1 is a top plan view of a pipeline plug, showing our new design in an inflated state;
 FIG. 2 is a side elevational view thereof;
 FIG. 3 is a front elevational view thereof;
 FIG. 4 is a rear elevational view thereof;
 FIG. 5 is a side elevational view thereof and showing the side opposite that of FIG. 2;
 FIG. 6 is a bottom plan view thereof;
 FIG. 7 is a top plan view thereof, in a deflated state;
 FIG. 8 is a side elevational view thereof;
 FIG. 9 is a front elevational view thereof;
 FIG. 10 is a rear elevational view thereof;
 FIG. 11 is a side elevational view thereof and showing the side opposite that of FIG. 8;
 FIG. 12 is a bottom plan view thereof;
 FIG. 13 is a top plan view of an alternate embodiment, showing our new design in an inflated state;
 FIG. 14 is a side elevational view thereof;
 FIG. 15 is a front elevational view thereof;
 FIG. 16 is a rear elevational view thereof;
 FIG. 17 is a rear elevational view thereof and showing the side opposite that of FIG. 14;
 FIG. 18 is a bottom plan view thereof; and,
 FIG. 19 is a perspective view of the pipeline plug of FIG. 1 and which shows our new design of a pipeline plug in an inflated state.

1 Claim, 19 Drawing Sheets

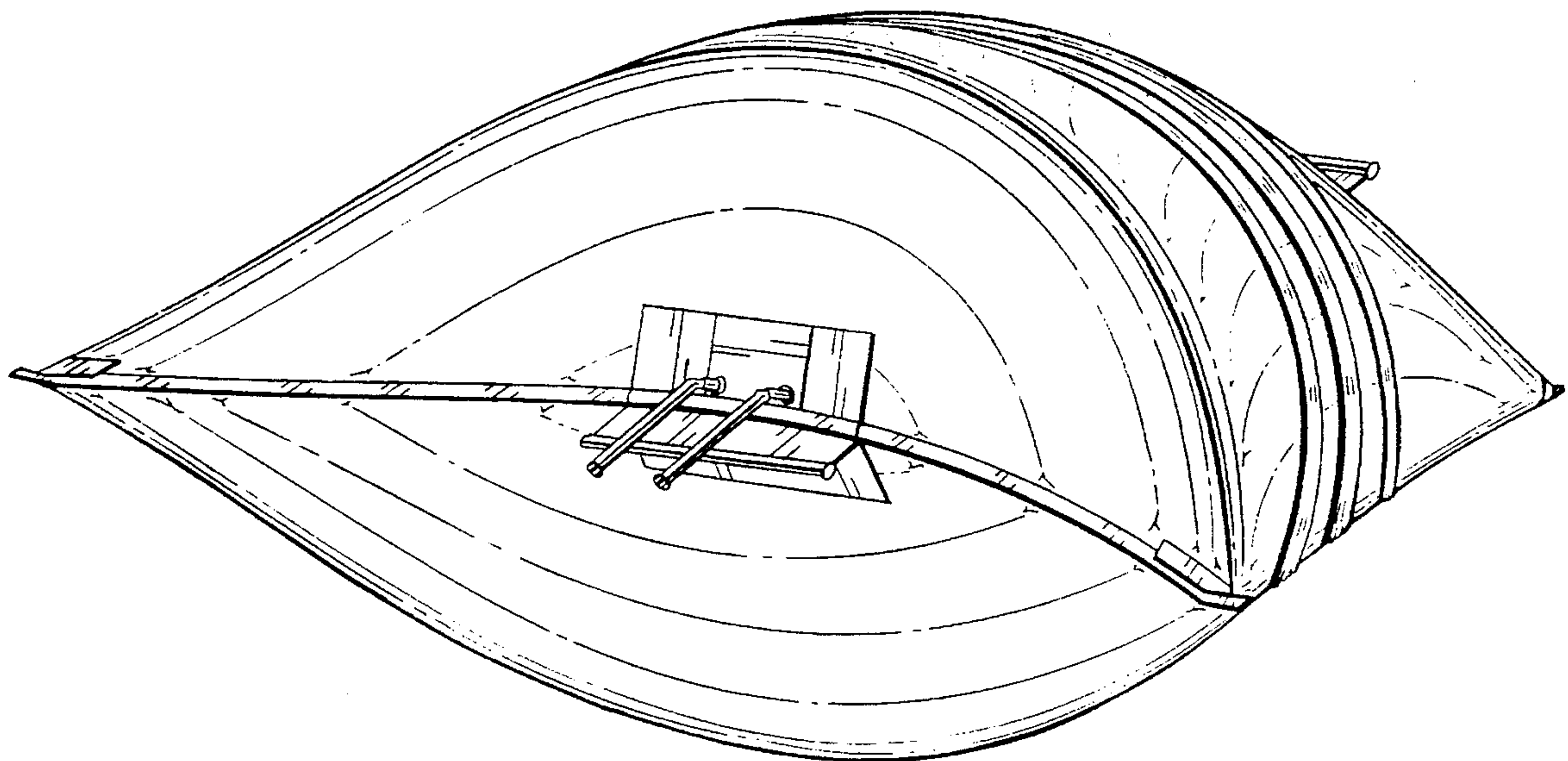

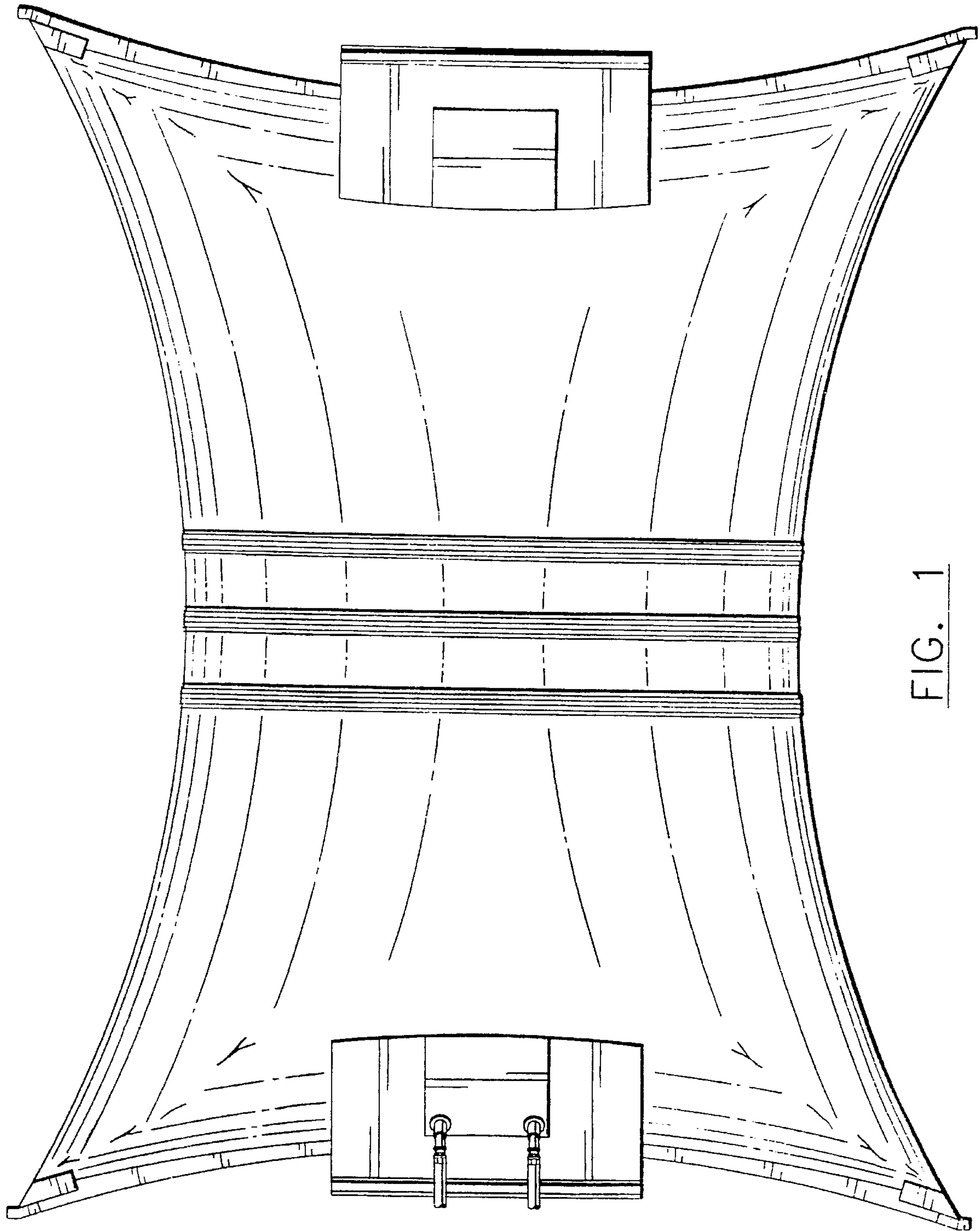

FIG. 1

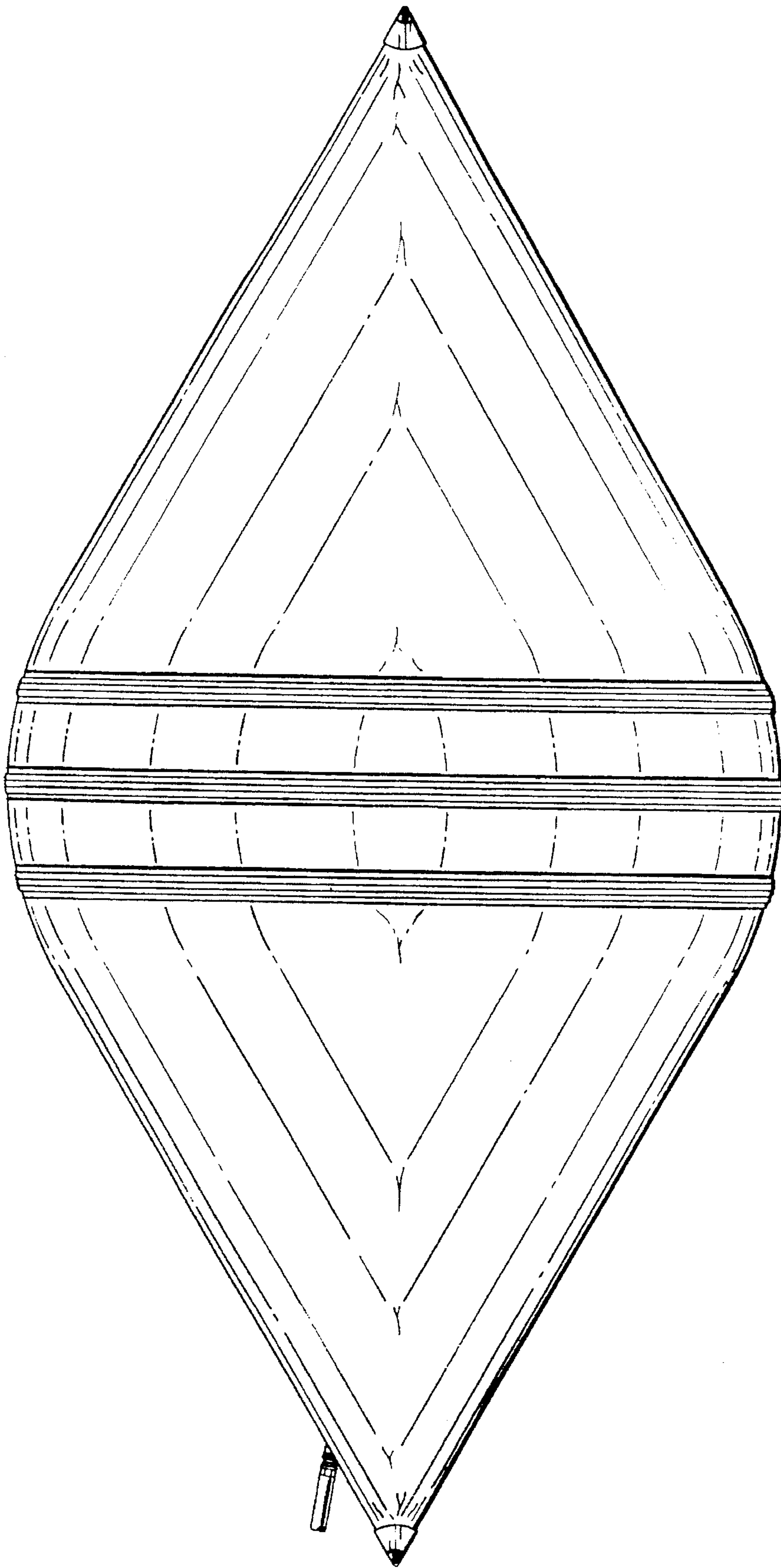

FIG. 2

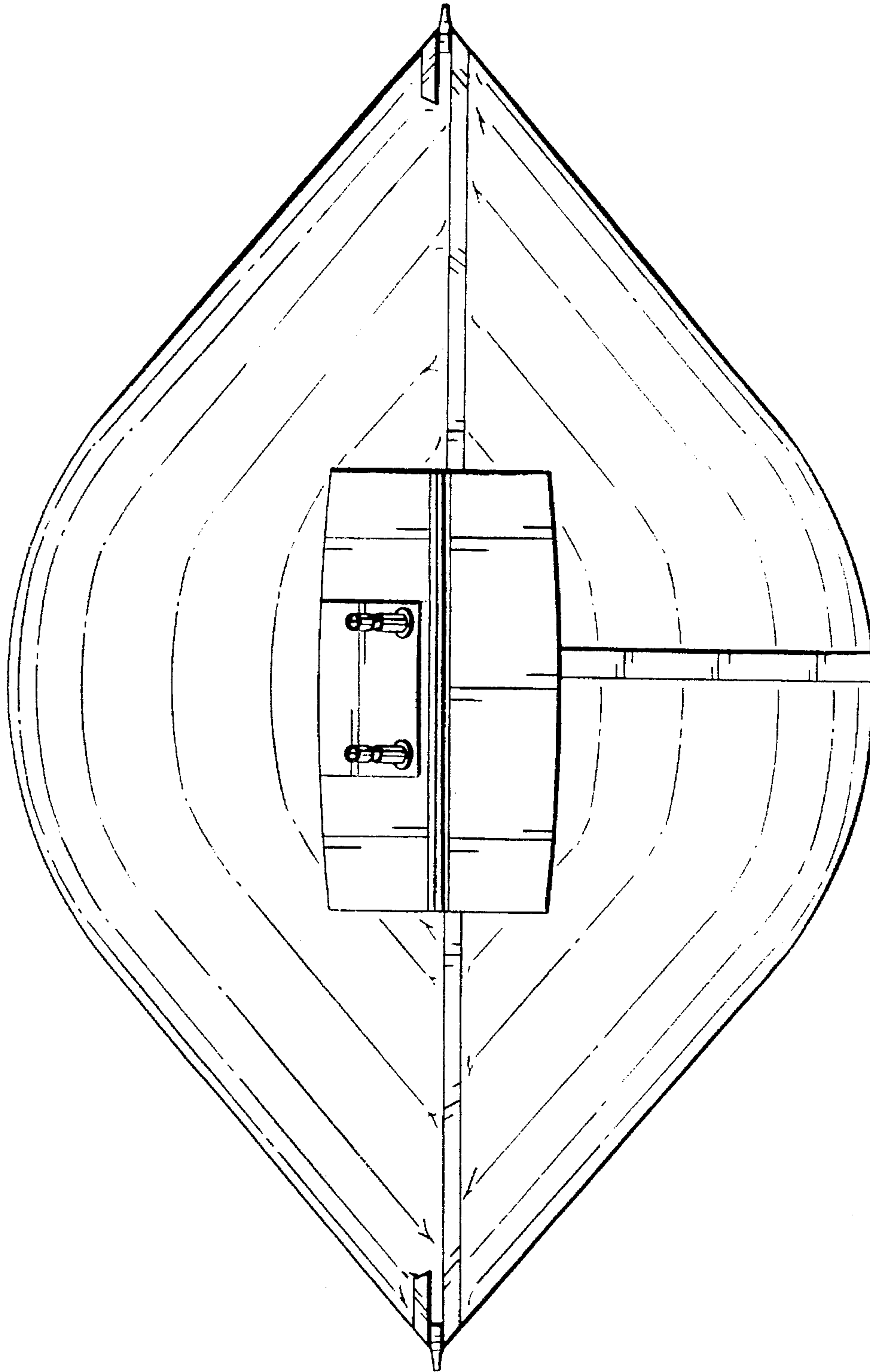

FIG. 3

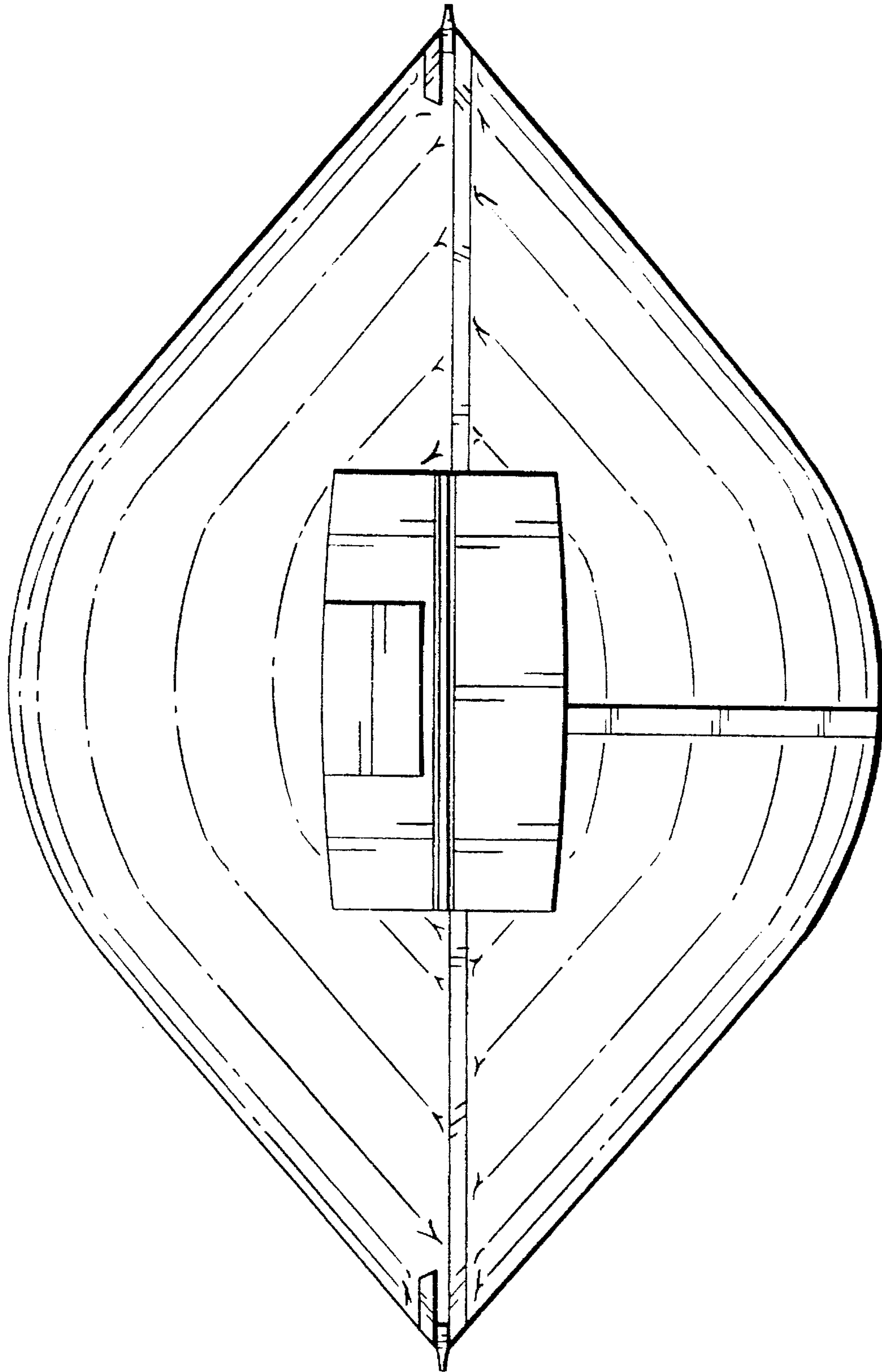

FIG. 4

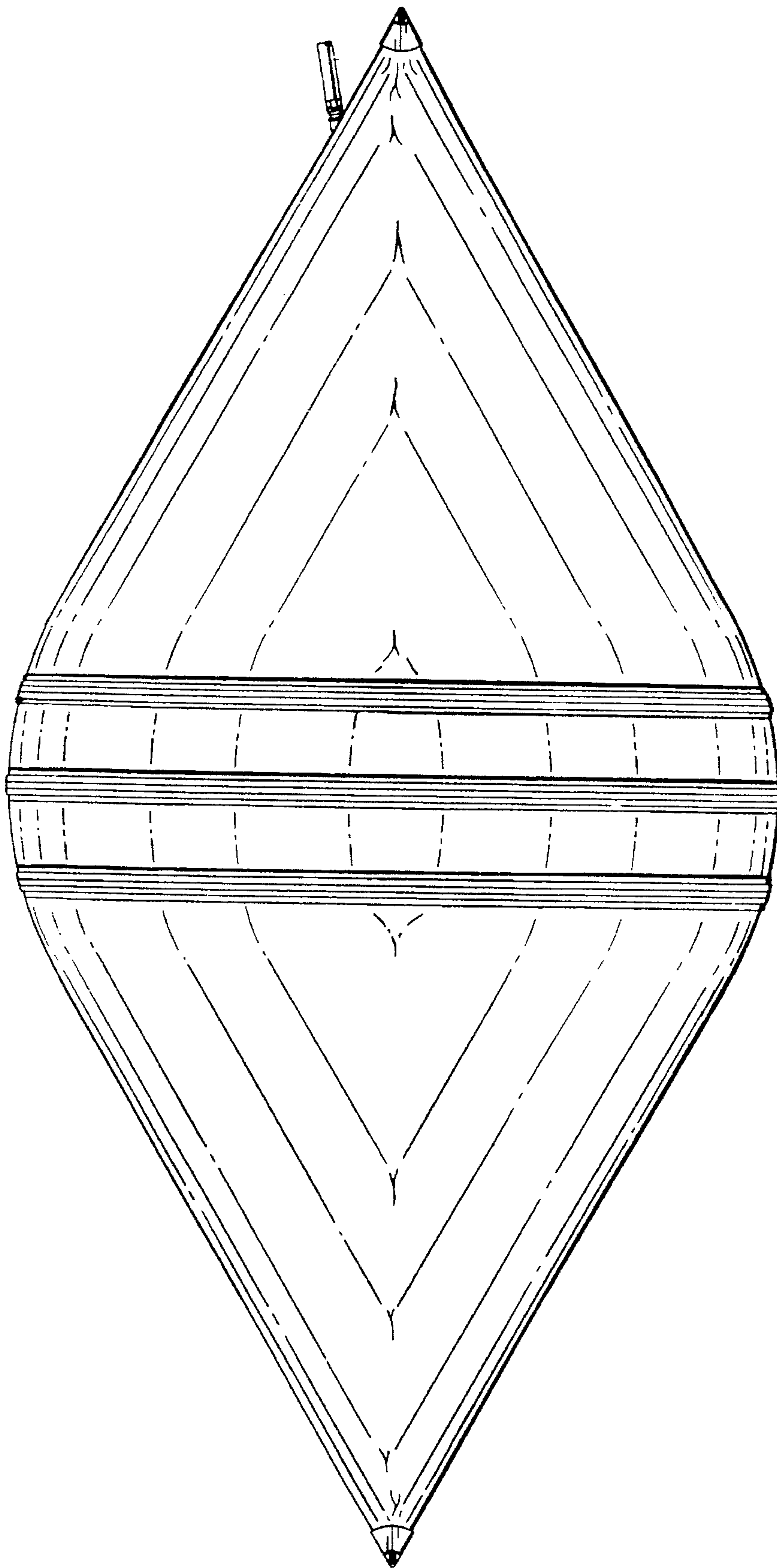

FIG. 5

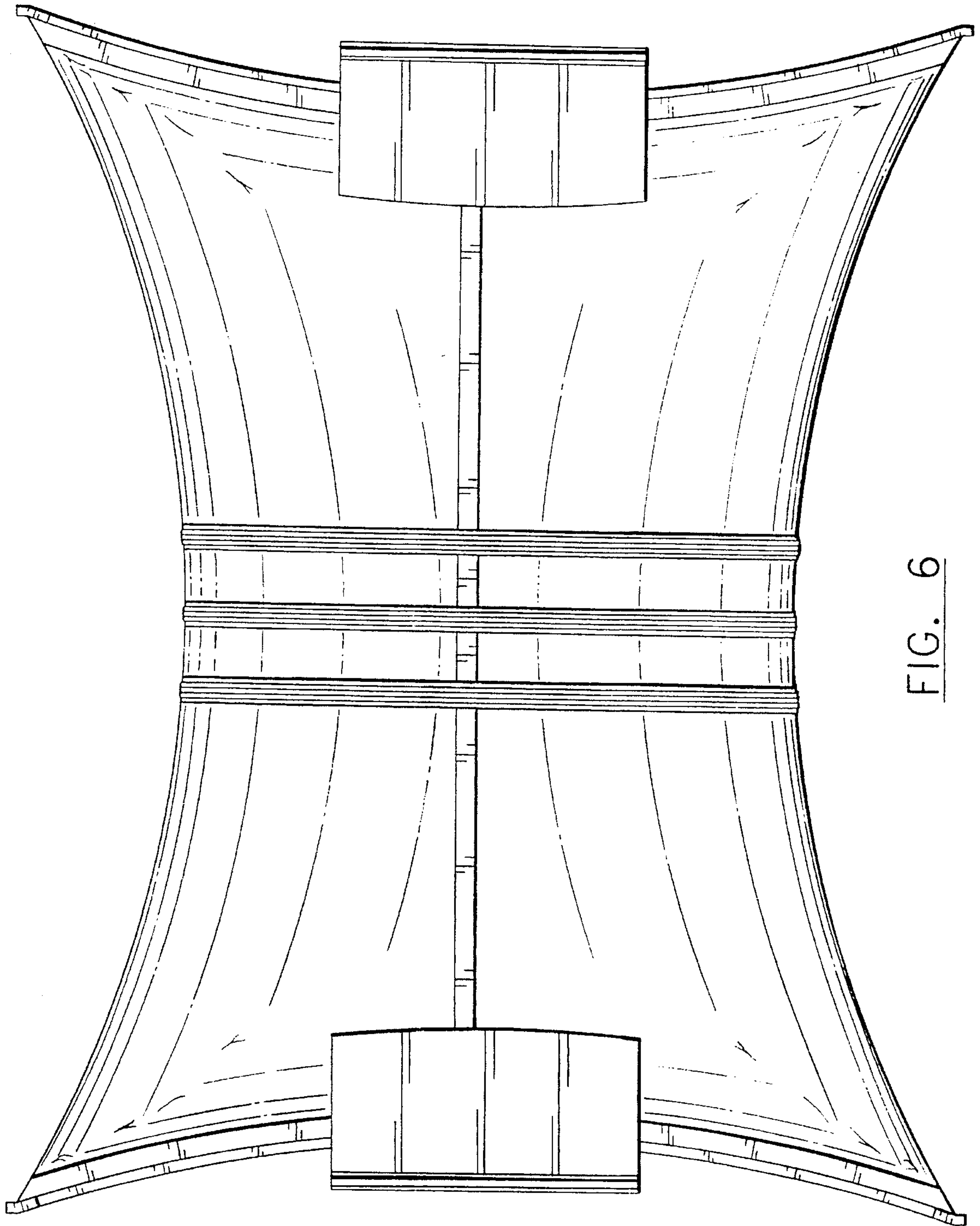

FIG. 6

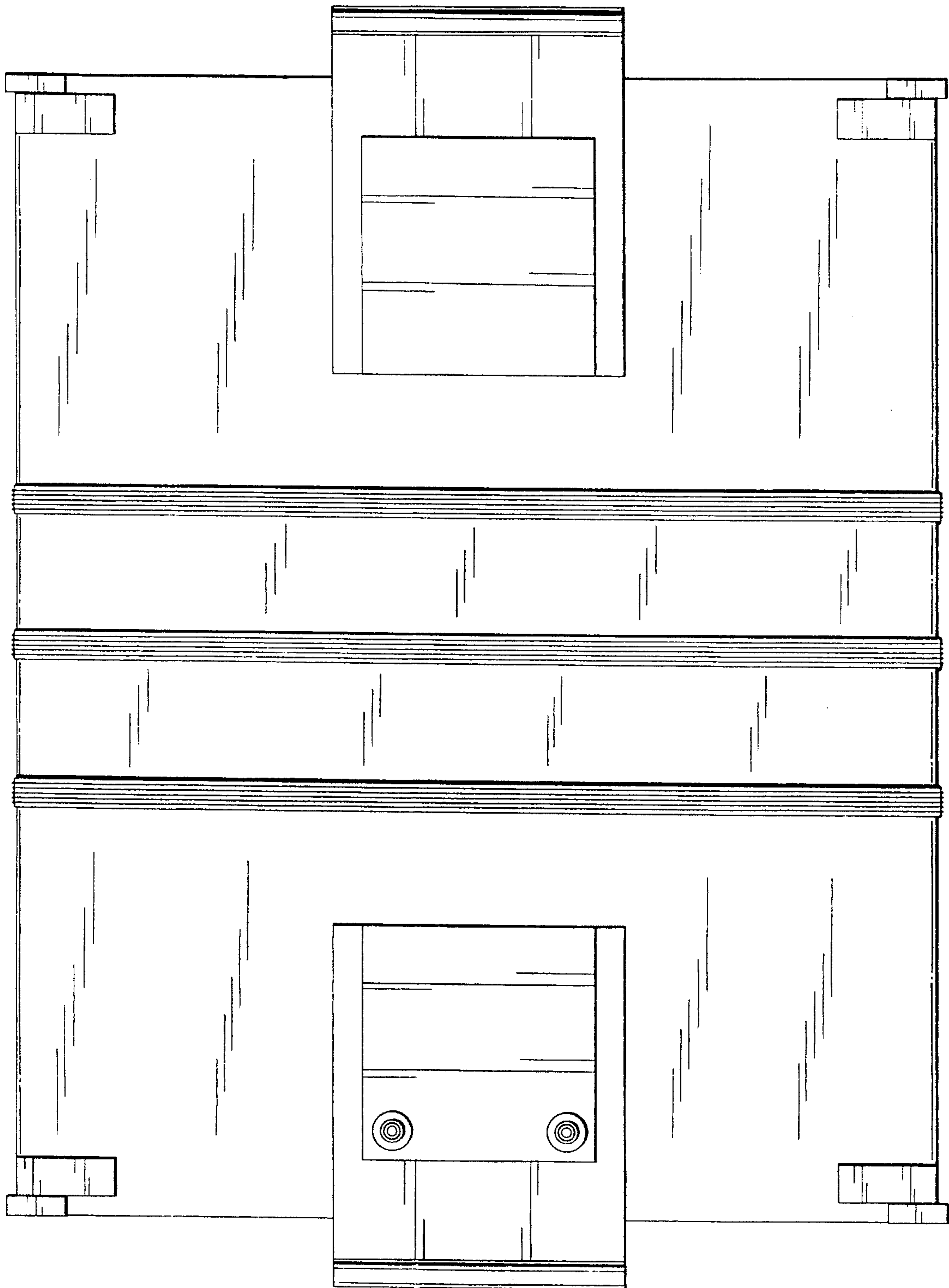

FIG. 7

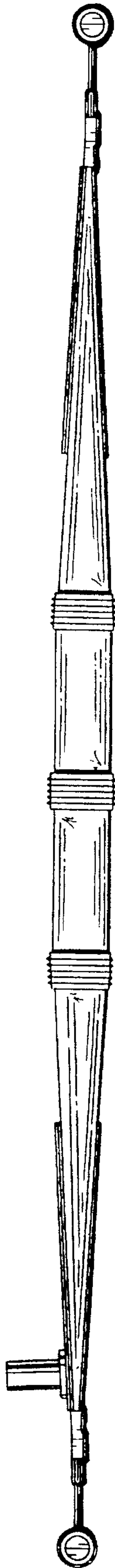

FIG. 8



FIG. 9

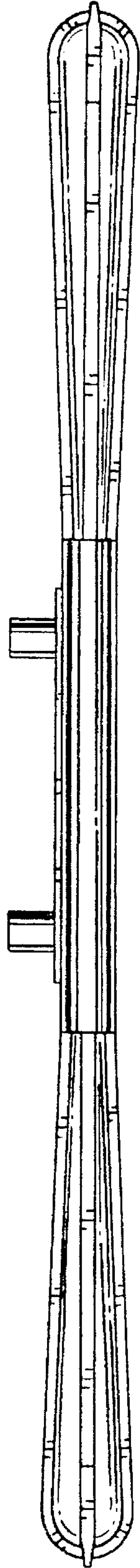

FIG. 10

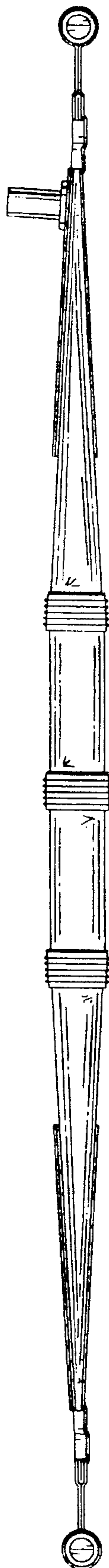

FIG. 11

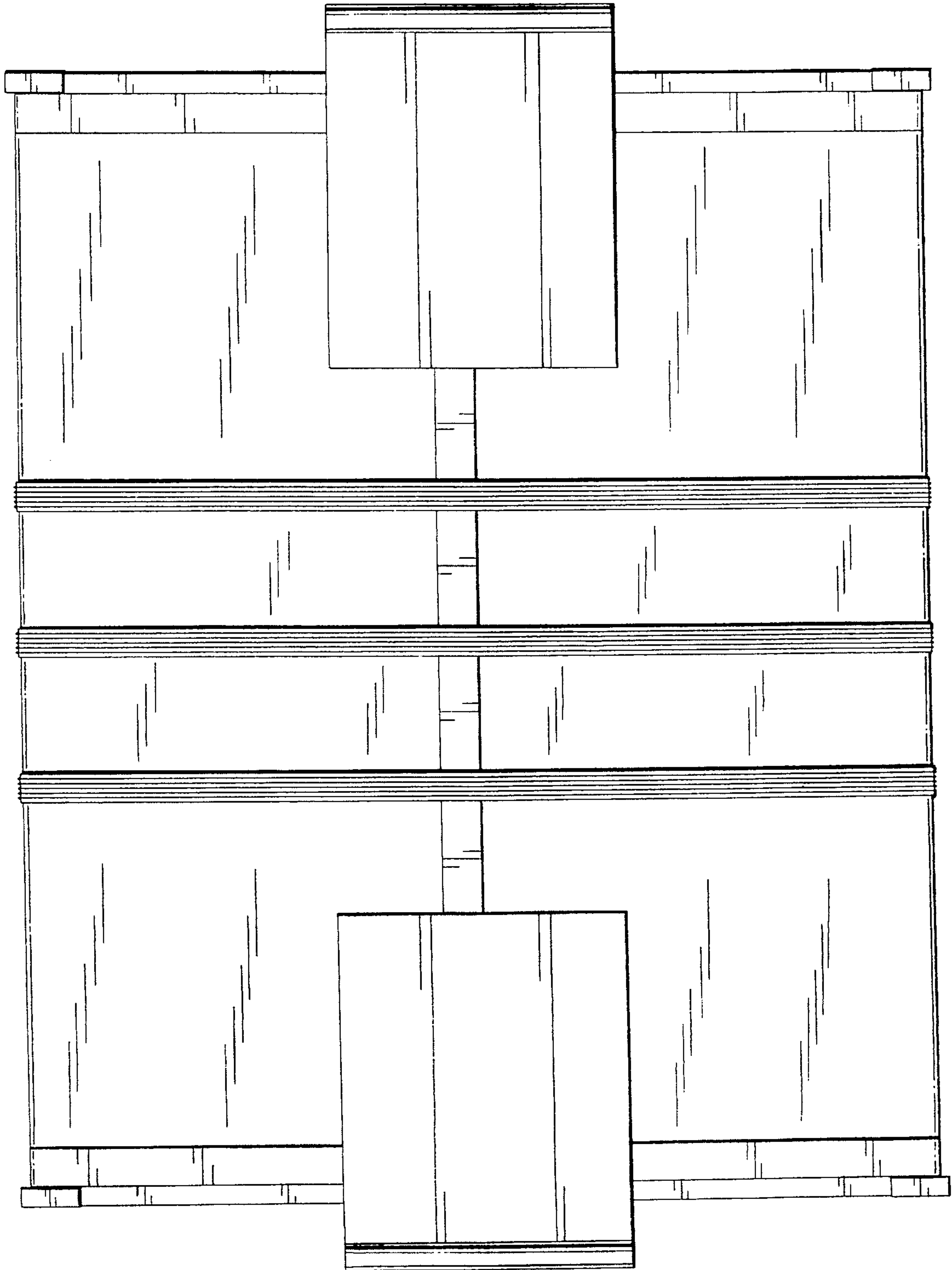

FIG. 12

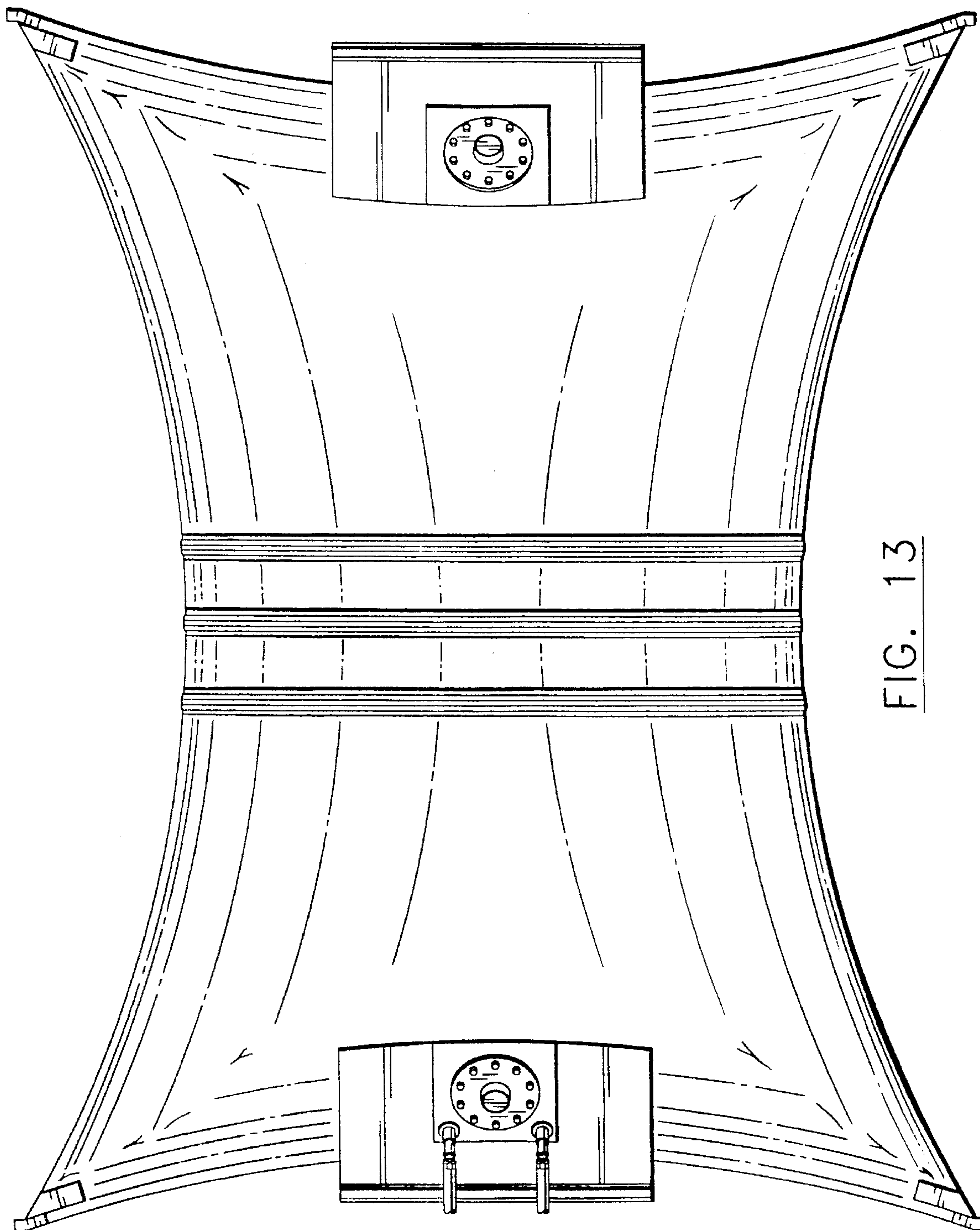

FIG. 13

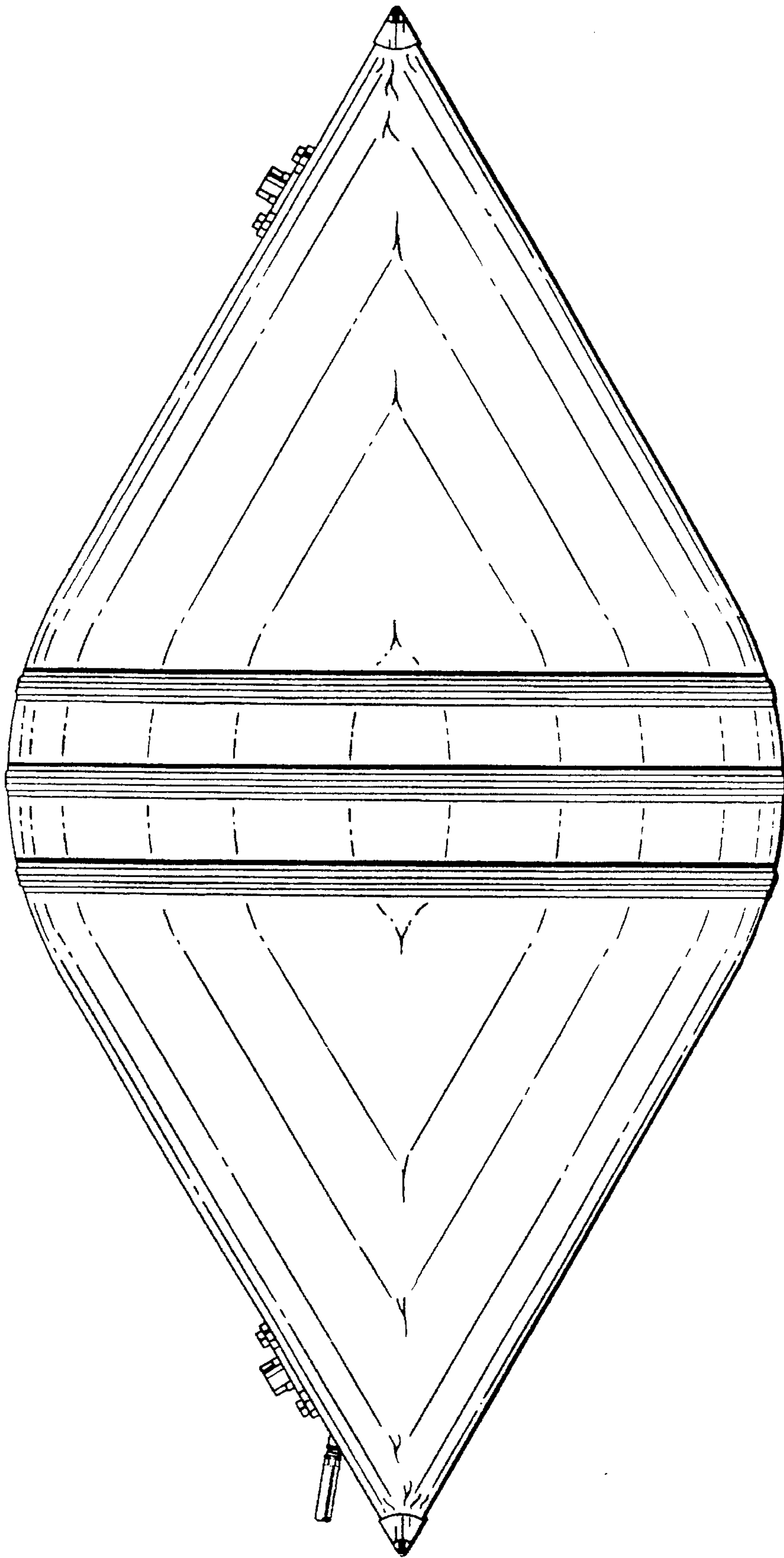

FIG. 14

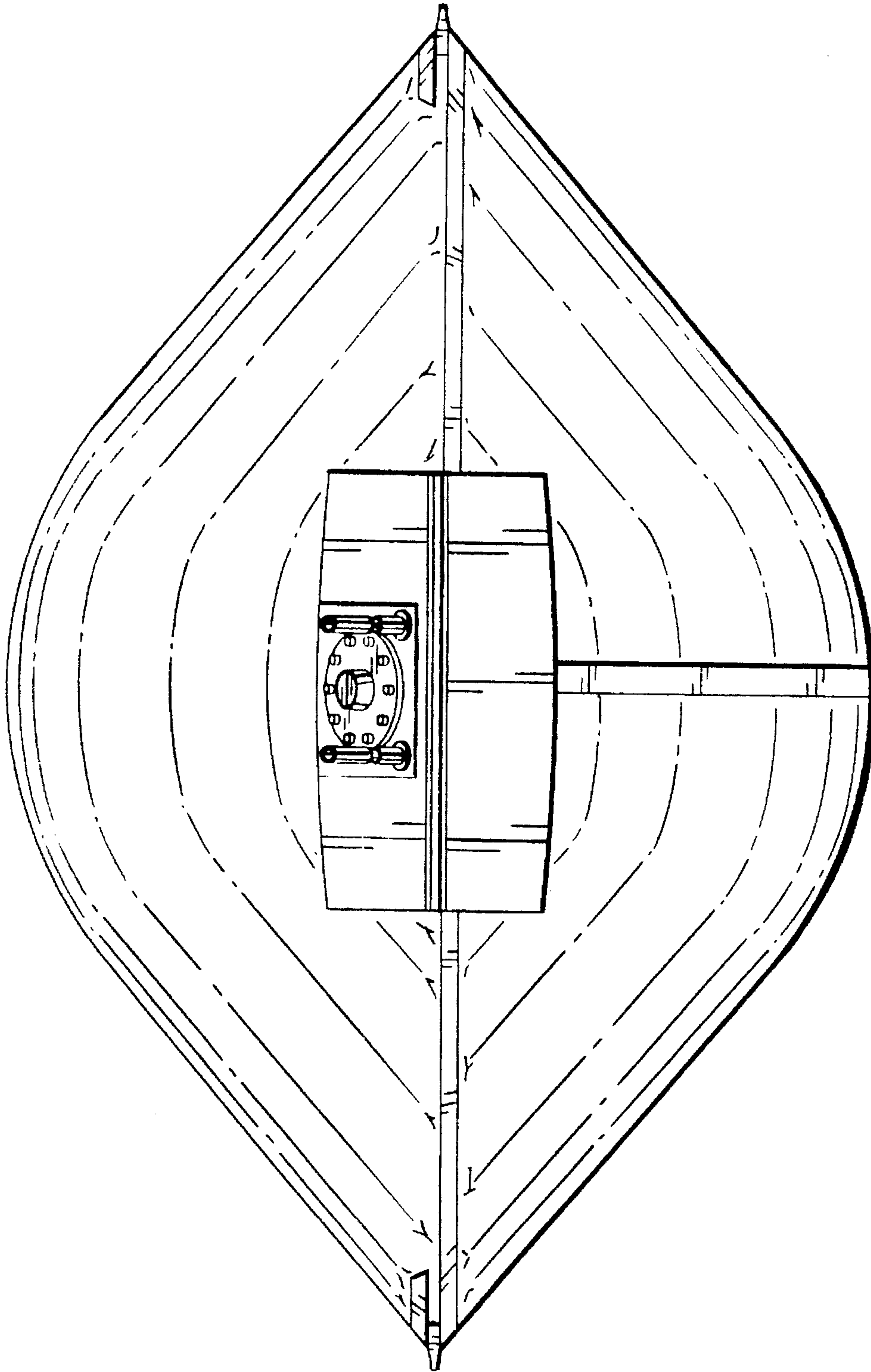

FIG. 15

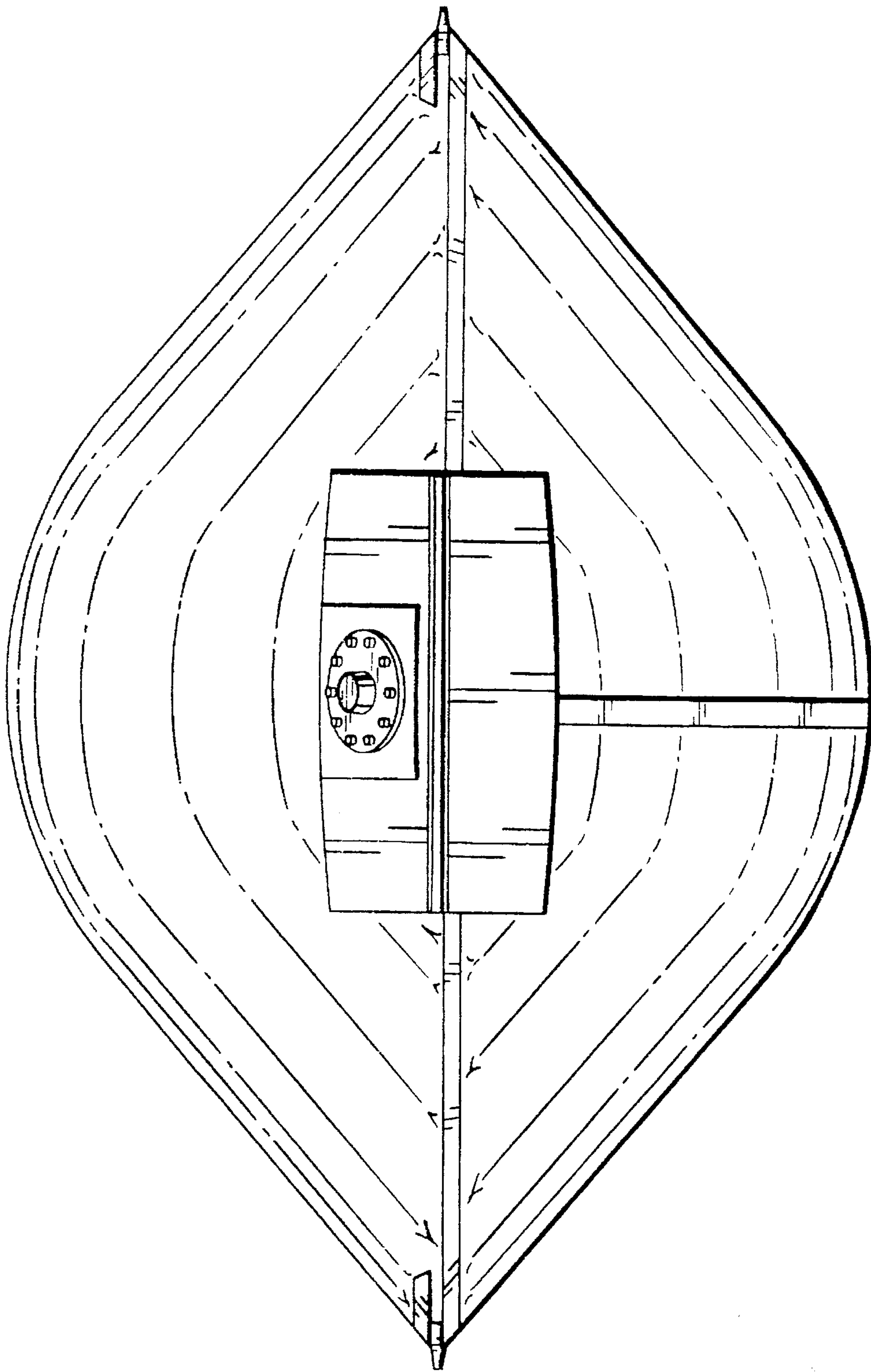

FIG. 16

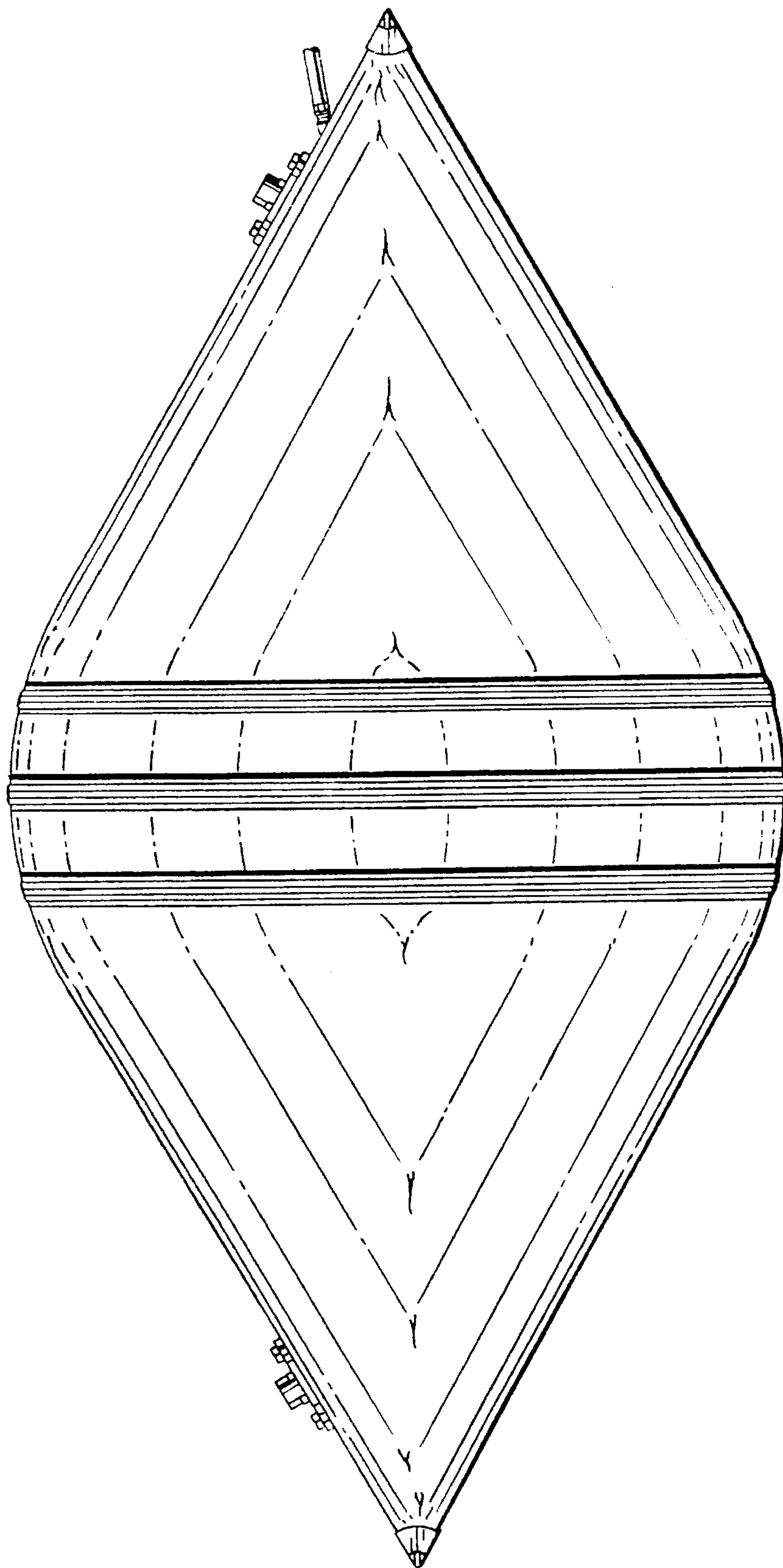

FIG. 17

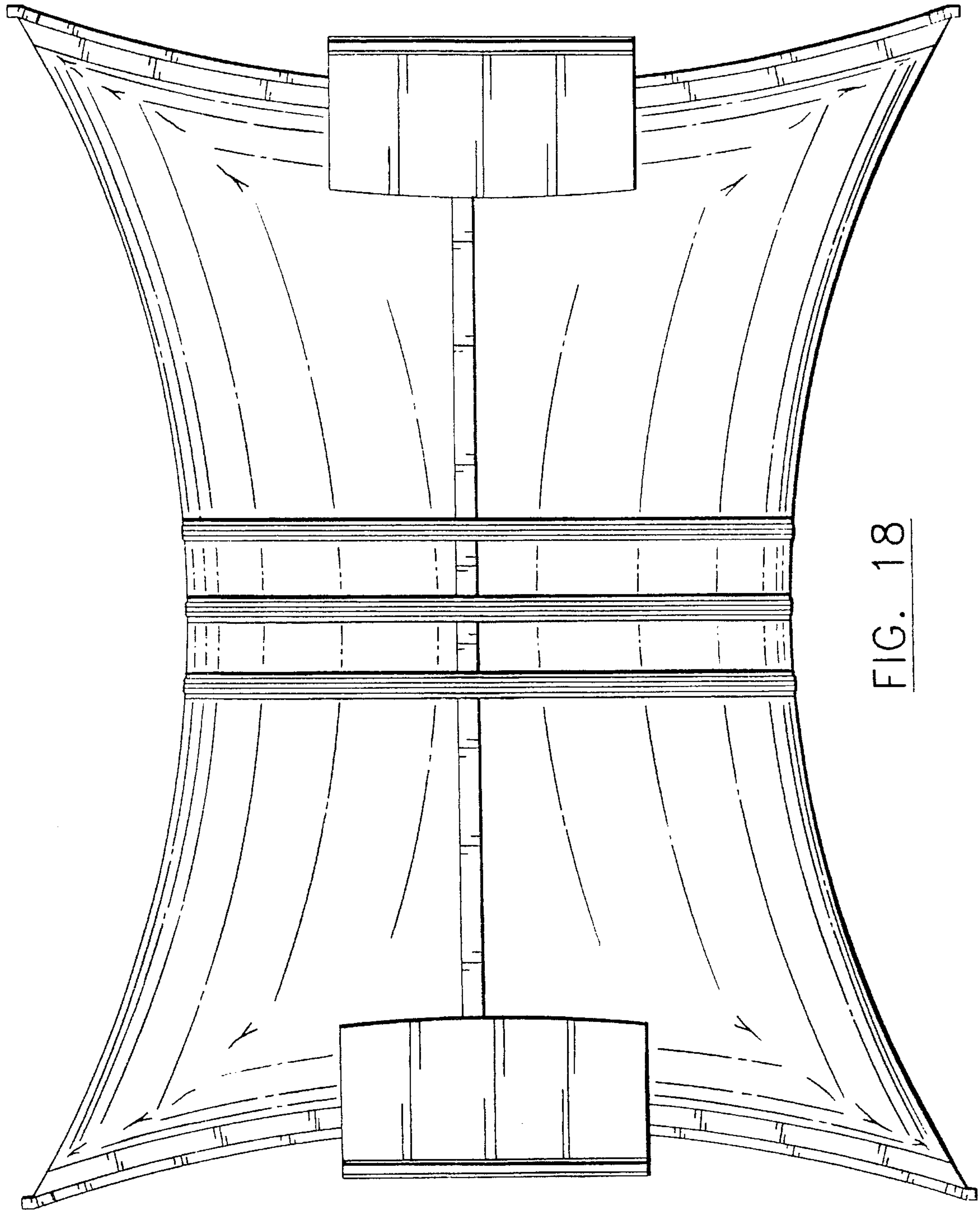

FIG. 18

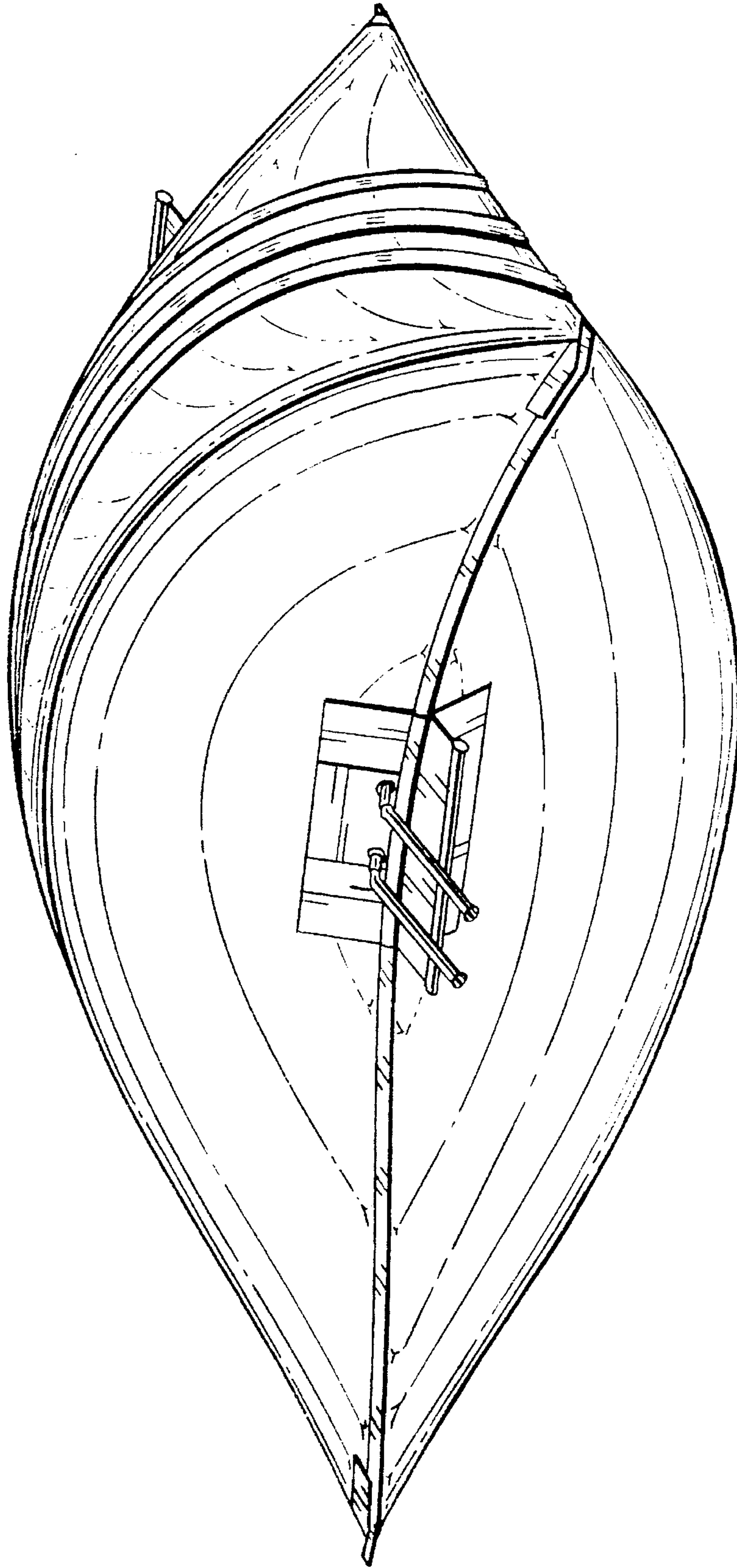

FIG. 19