



US00D378629S

# United States Patent [19]

Passke et al.

[11] Patent Number: Des. 378,629

[45] Date of Patent: \*\*Apr. 1, 1997

[54] BLADDER FOR A SHOE SOLE

5,351,710 10/1994 Phillips ..... 36/114  
5,353,459 10/1994 Potter et al. .... 36/29 X

[75] Inventors: Joel L. Passke, Portland; James C. Sell, Jr., Beaverton, both of Oreg.

### OTHER PUBLICATIONS

Exhibits A-H, Photographs of Bladders.

[73] Assignee: Nike, Inc., Beaverton, Oreg.

Primary Examiner—Doris V. Coles

[\*\*] Term: 14 Years

Attorney, Agent, or Firm—Banner & Witcoff, Ltd.

[21] Appl. No.: 55,318

### [57] CLAIM

[22] Filed: Jun. 3, 1996

The ornamental design for a bladder for a shoe sole, as shown and described.

[52] U.S. Cl. .... D2/961

### DESCRIPTION

[58] Field of Search ..... D2/961, 968; 36/44, 36/29, 43, 37, 35 R, 114, 28, 137, 88

FIG. 1 is a perspective view of a bladder for a shoe sole showing our new design;

### [56] References Cited

#### U.S. PATENT DOCUMENTS

D. 336,772	6/1993	Forland et al. ....	D2/961
D. 349,186	8/1994	Passke et al. ....	D2/961
D. 349,804	8/1994	Passke et al. ....	D2/961
D. 351,056	10/1994	Auger et al. ....	D2/961
D. 363,816	11/1995	Sarkinen et al. ....	D2/961
D. 364,035	11/1995	Lee .....	D2/961
D. 364,036	11/1995	Passke et al. ....	D2/961

FIG. 2 is a top plan view thereof;

FIG. 3 is a left side elevational view thereof;

FIG. 4 is a right side view thereof;

FIG. 5 is a front view thereof;

FIG. 6 is a rear elevational view thereof; and,

FIG. 7 is a cross-sectional view taken along the line 7—7 of FIG. 2.

1 Claim, 2 Drawing Sheets

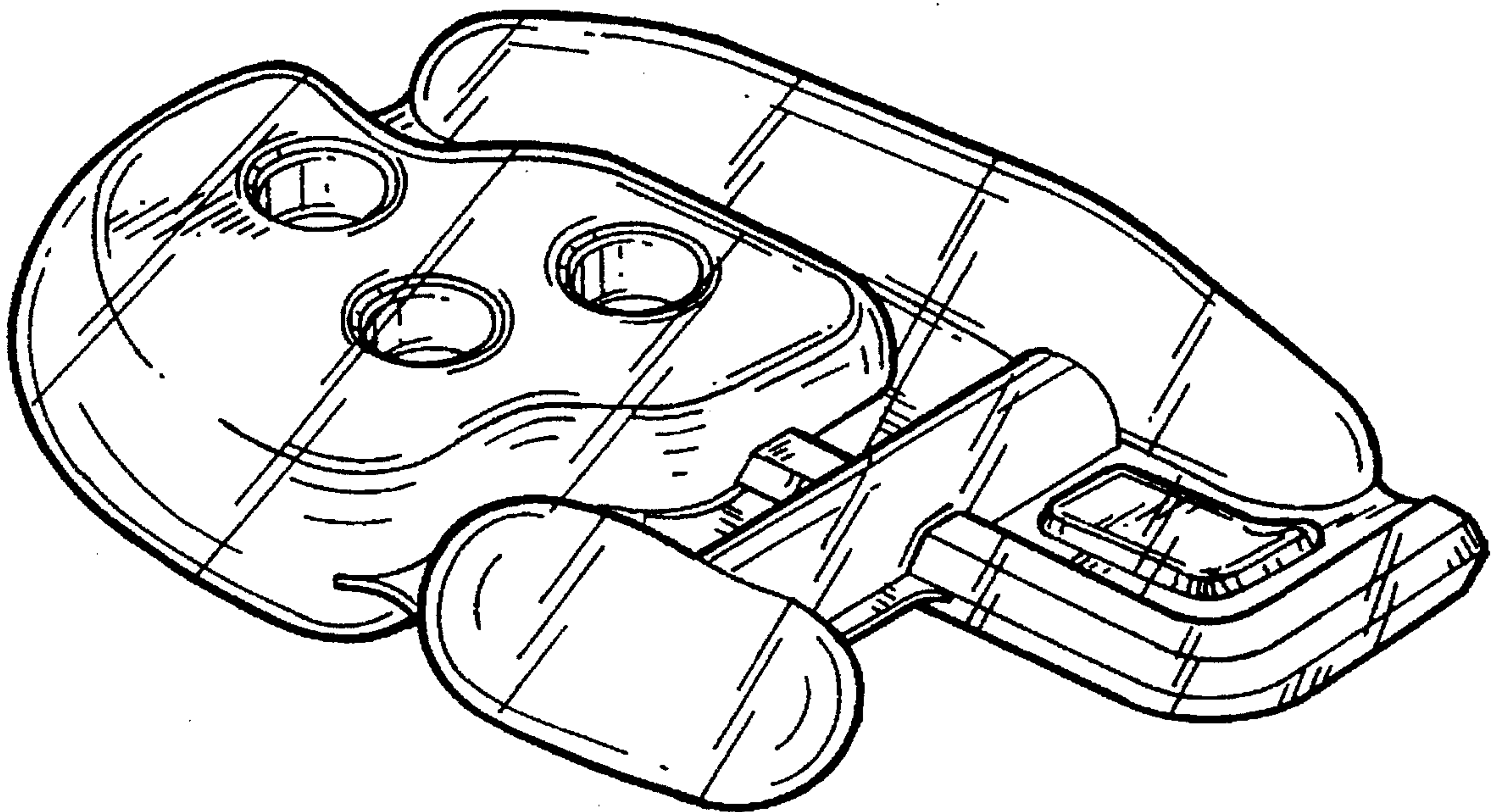

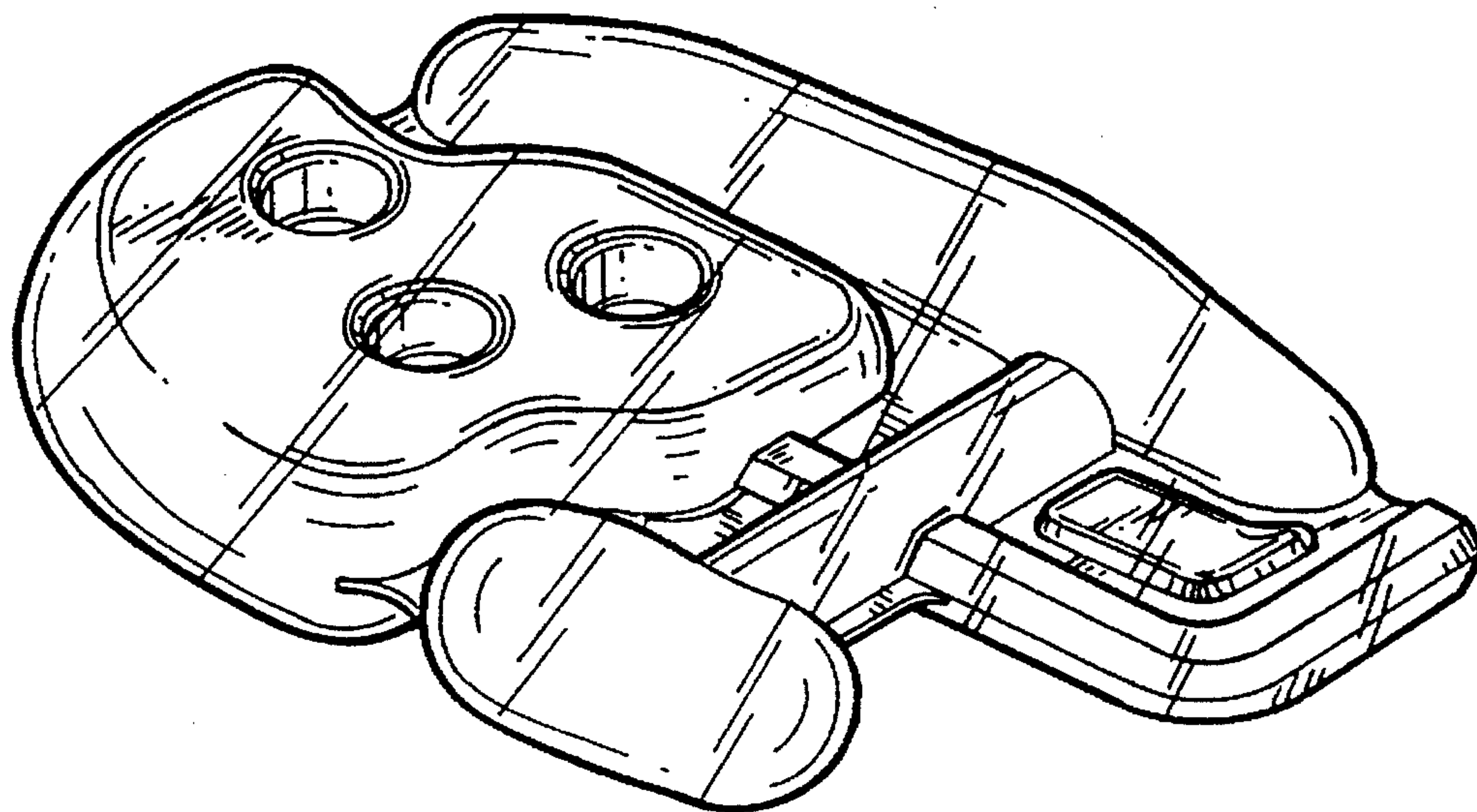

FIG. 1

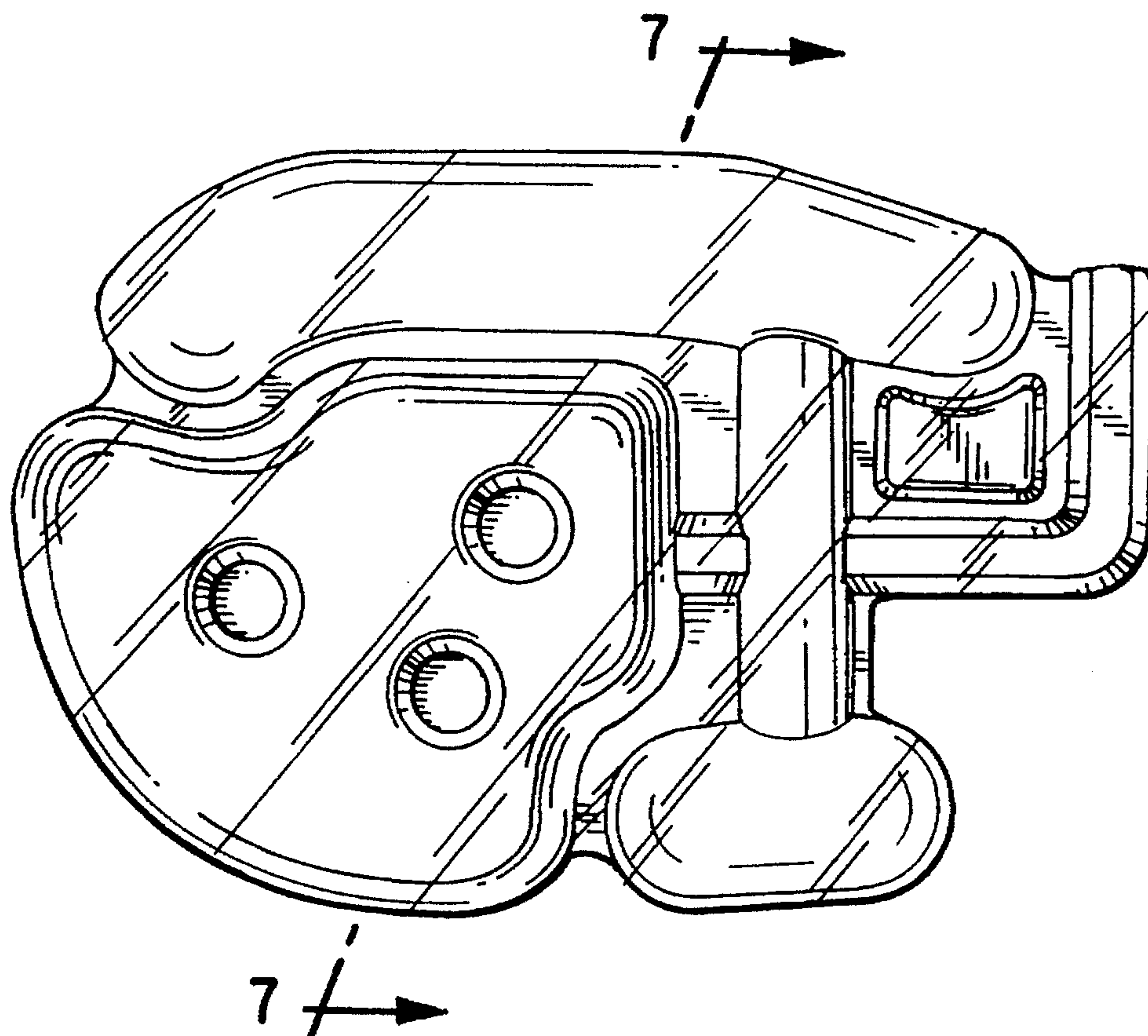

FIG. 2

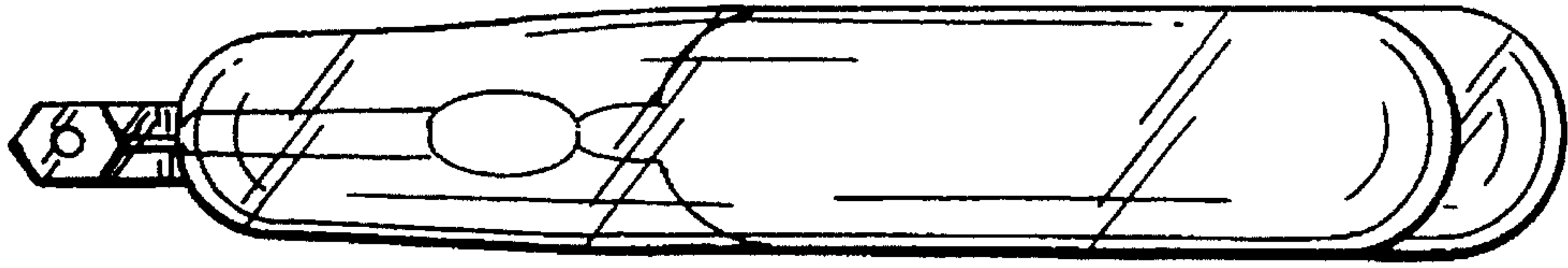

FIG. 3

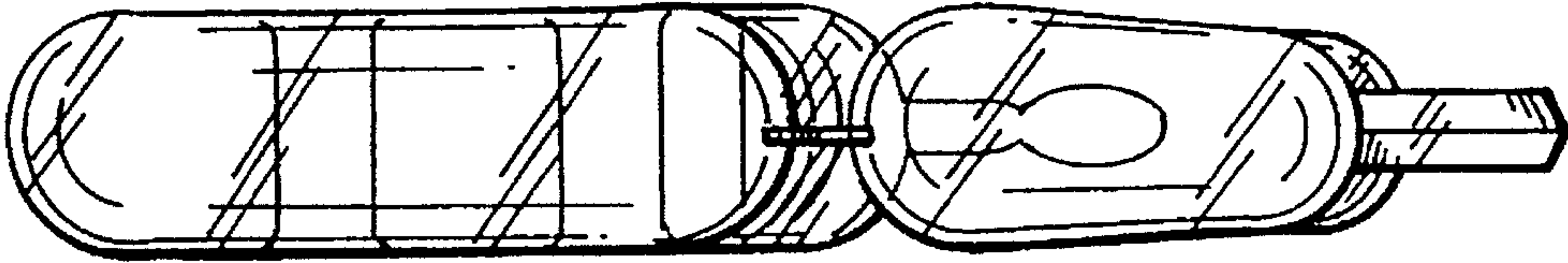

FIG. 4

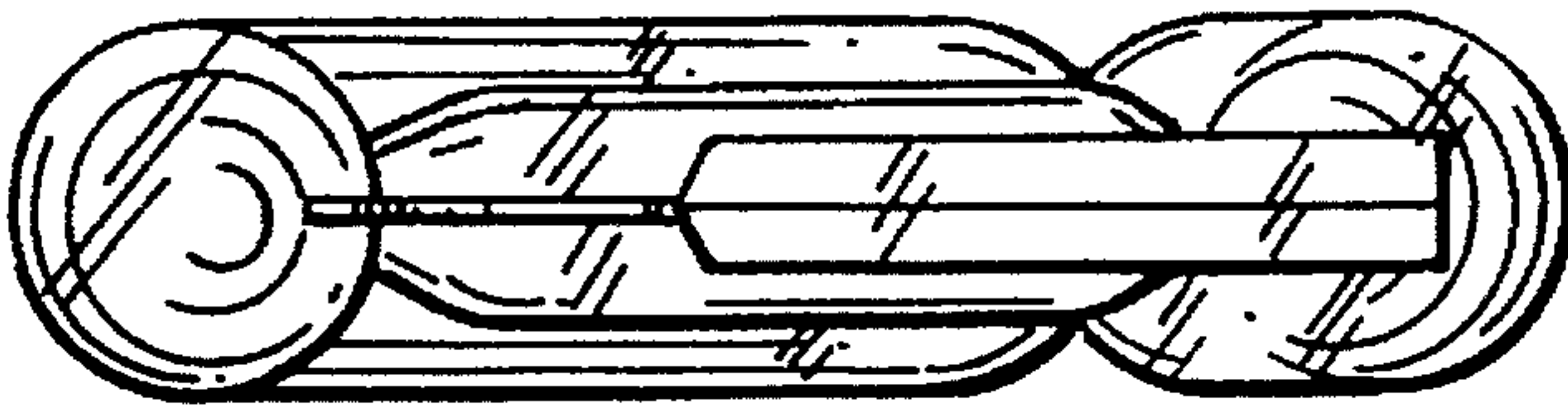

FIG. 5

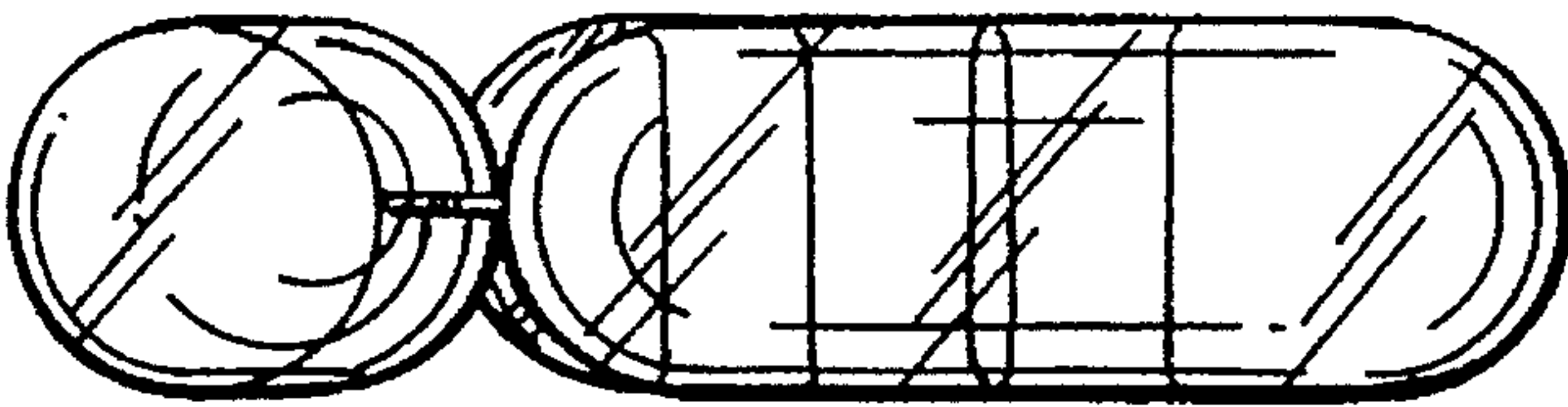

FIG. 6

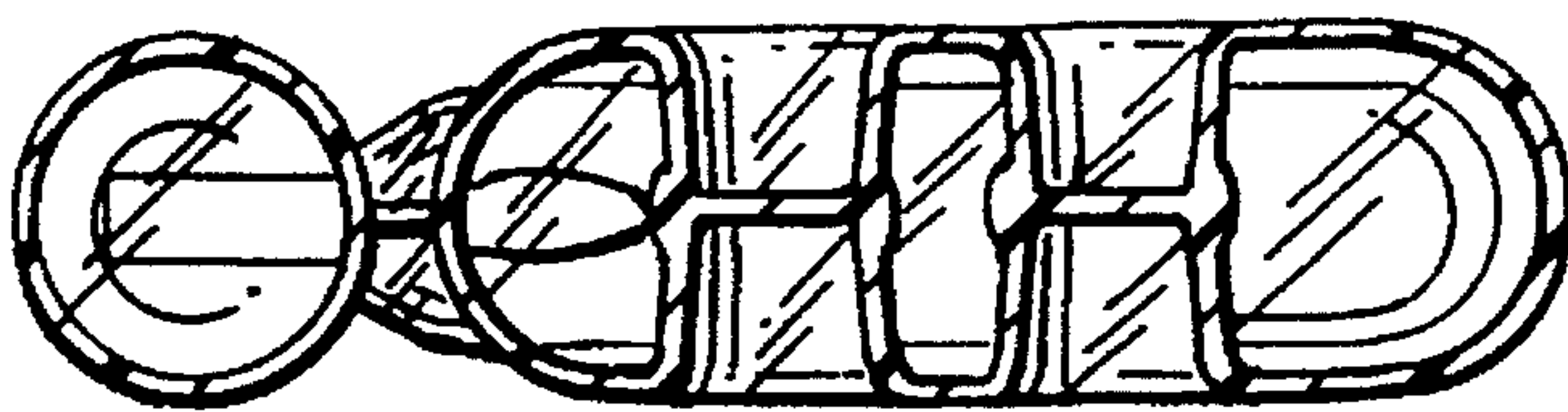

FIG. 7