



US00D378616S

United States Patent [19]

Marinoni

[11] Patent Number: **Des. 378,616**

[45] Date of Patent: ****Mar. 25, 1997**

[54] **COMBINED TEMPERED GLASS DOOR AND ITS MAIN FITTINGS**

[75] Inventor: **Mario Marinoni**, Magenta, Italy

[73] Assignee: **Societa Italiana Progetti S.R.L.**,
Magenta, Italy

[**] Term: **14 Years**

[21] Appl. No.: **30,318**

[22] Filed: **Oct. 26, 1994**

[52] U.S. Cl. **D25/48**

[58] Field of Search D25/48; 52/455,
52/456, 457, 458; 49/371, 381, 384, 501,
504; 16/224, 273

[56] **References Cited**

U.S. PATENT DOCUMENTS

D. 305,067	12/1989	Borgen	D25/48
D. 355,037	1/1995	Horgan, Jr.	D25/48
5,319,882	6/1994	Biebuyck	52/455

Primary Examiner—Doris Clark
Attorney, Agent, or Firm—Kuhn and Muller

[57] **CLAIM**

The ornamental design for a combined tempered glass door and its main fittings, as shown and described.

DESCRIPTION

FIG. 1 is a perspective view of a combined tempered glass door and its main fittings, the broken lines showing a wall

is for illustrative purposes only and forms no part of the claimed design;

FIG. 2 is an enlarged front elevational view of a locking fitting of the tempered glass door as in FIG. 1;

FIG. 3 is an enlarged bottom view of the locking fitting as in FIG. 2;

FIG. 4 is an enlarged top plan view thereof;

FIG. 5 is an enlarged left side elevational view thereof;

FIG. 6 is an enlarged right side elevational view thereof;

FIG. 7 an enlarged rear view thereof;

FIG. 8 is an enlarged perspective view thereof;

FIG. 9 is an enlarged front elevational view of a non-locking hinged fitting of the combined tempered glass door, and its main fittings as in FIG. 1;

FIG. 10 is an enlarged bottom view of the non-locking hinged fitting of the combined tempered glass door and its main fittings as in FIG. 1;

FIG. 11 is an enlarged top plan view thereof;

FIG. 12 is an enlarged left side elevational view thereof;

FIG. 13 is an enlarged right side elevational view thereof;

FIG. 14 is an enlarged rear view thereof;

FIG. 15 is an enlarged perspective view thereof; and,

FIG. 16 is a perspective view of a second embodiment of a combined tempered glass door and its main fittings, the broken lines showing a wall is for illustrative purposes only, and forms no part of the claimed design.

1 Claim, 6 Drawing Sheets

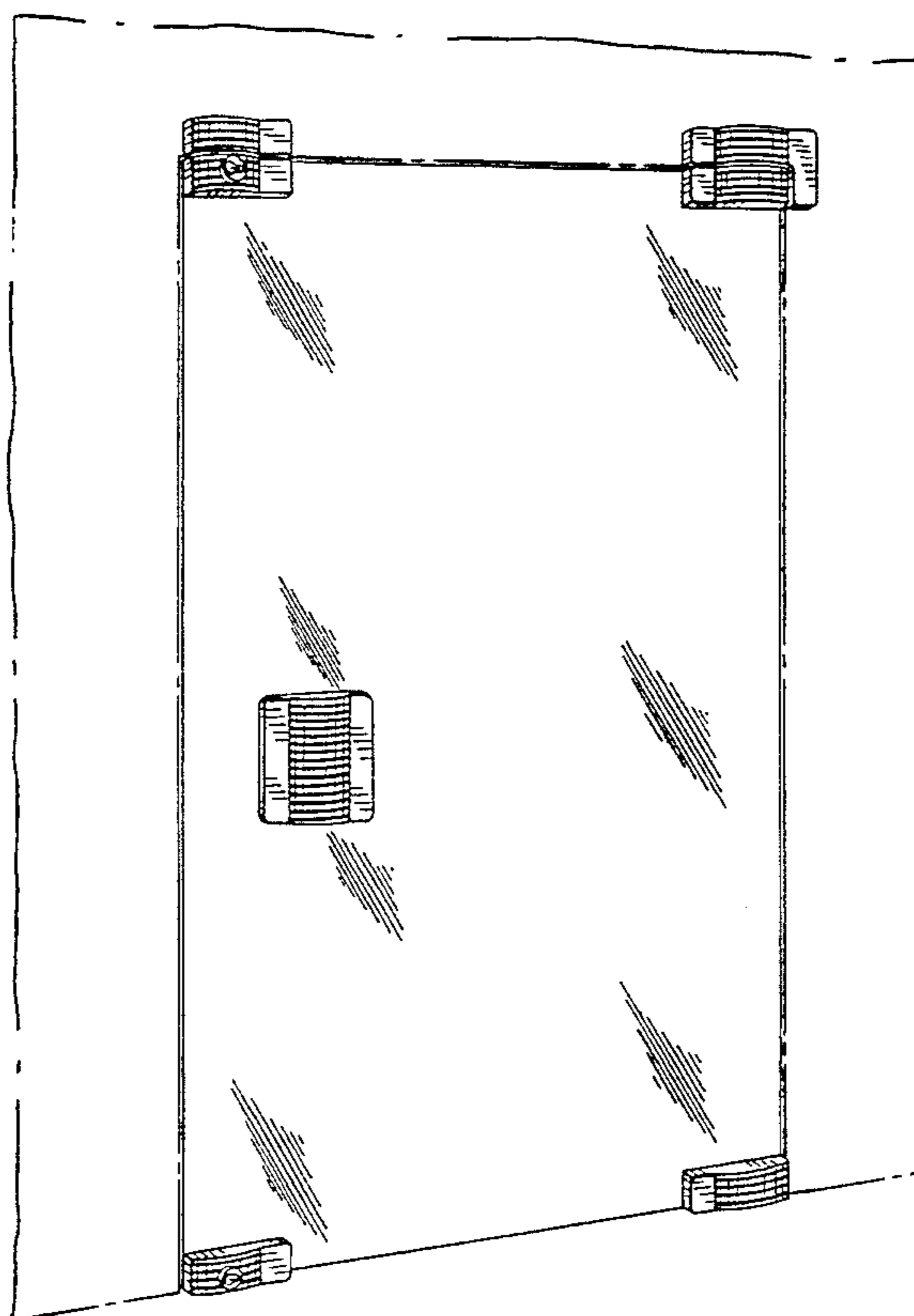

FIG. 1

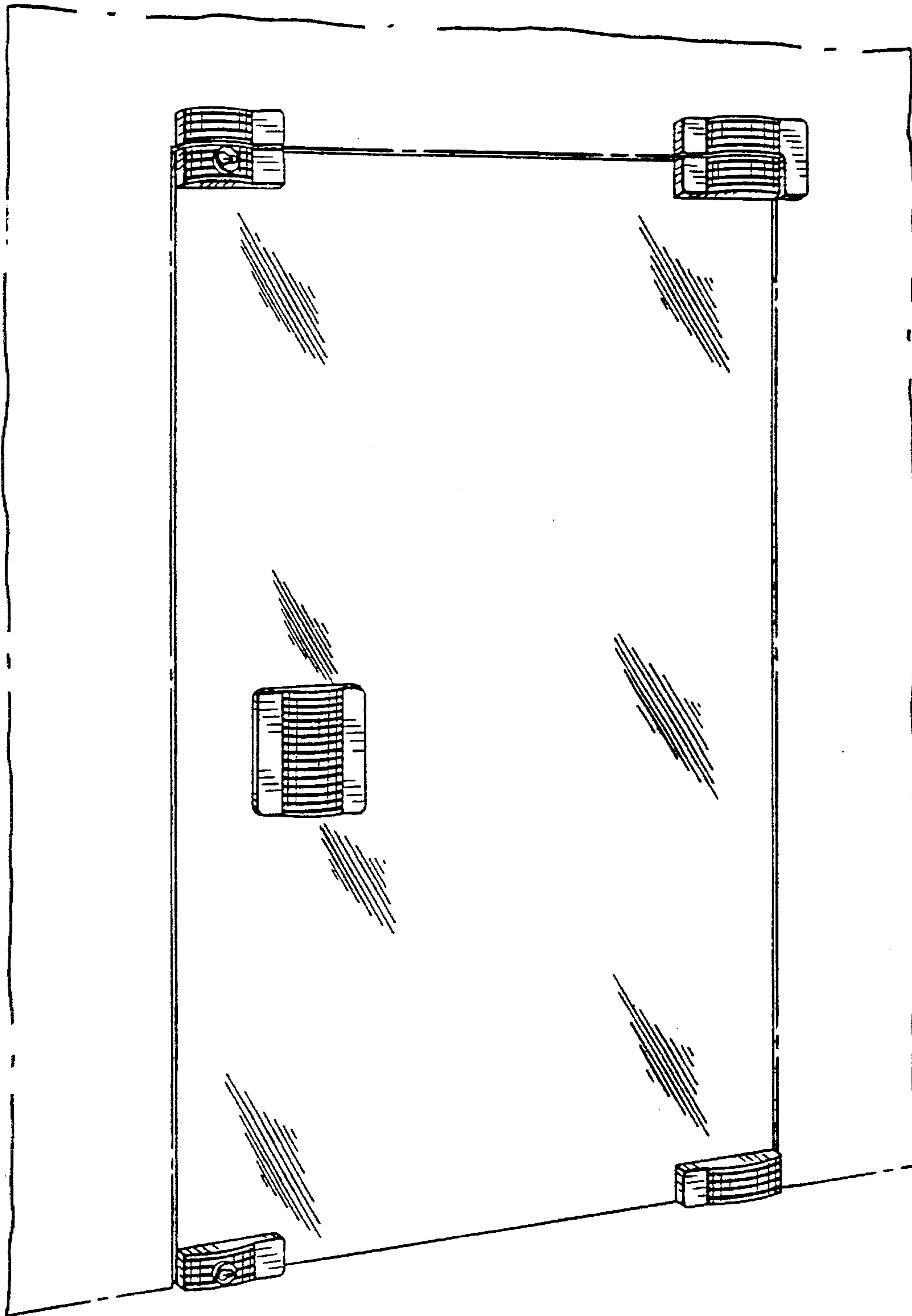

FIG. 2

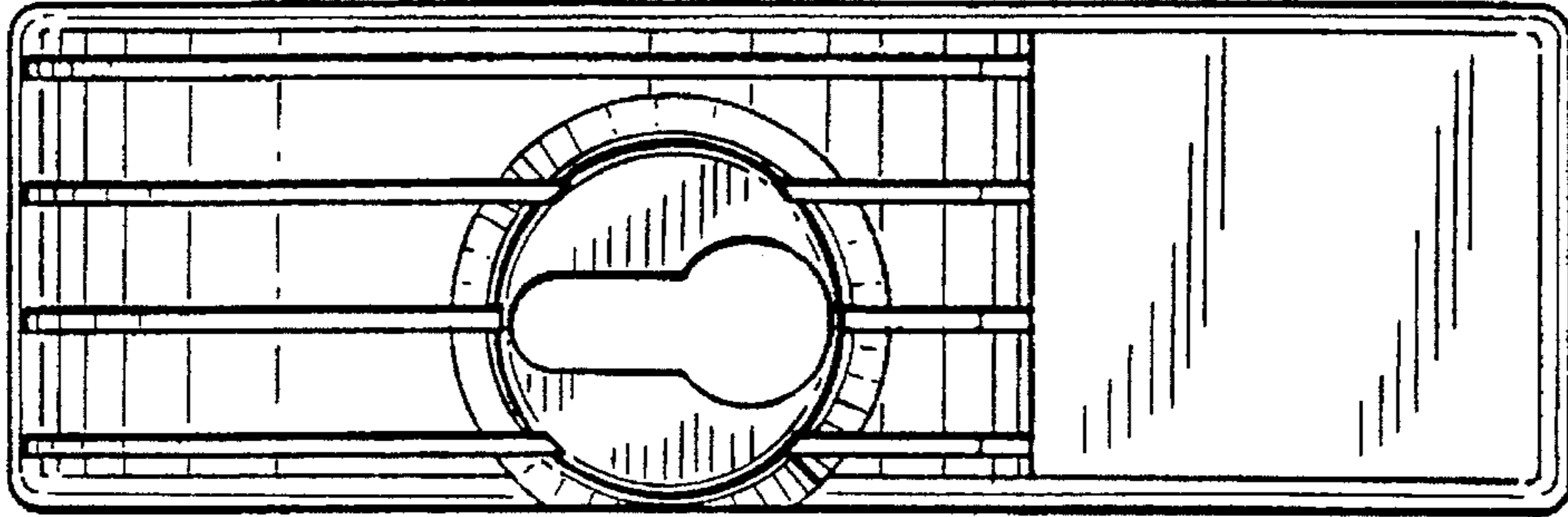

FIG. 3

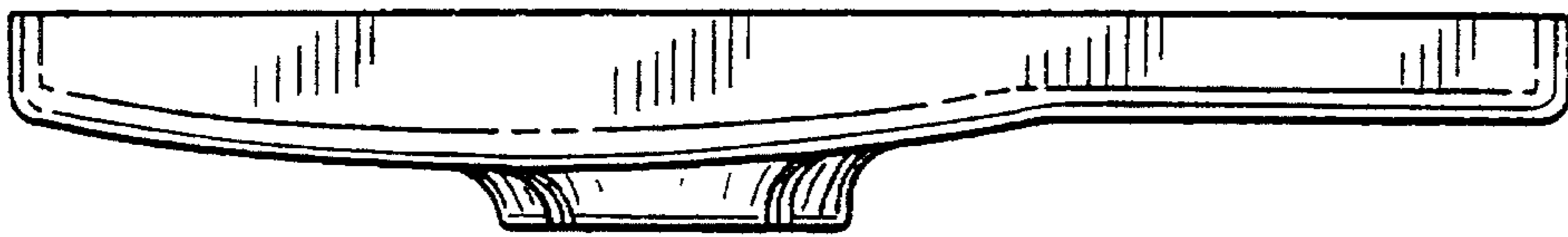

FIG. 4

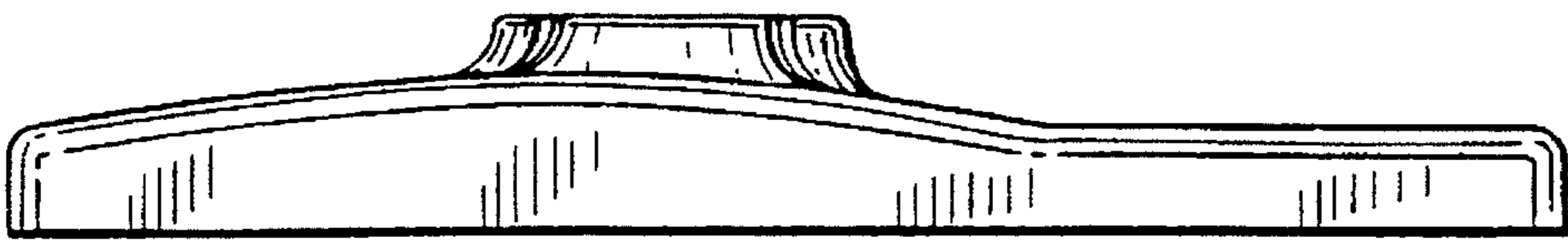

FIG. 5

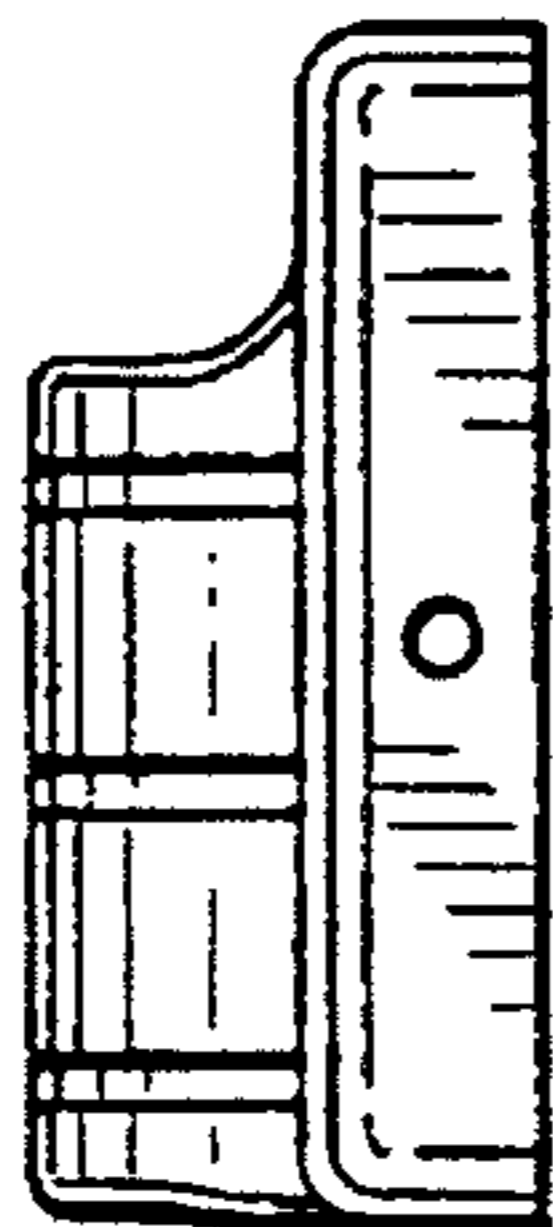

FIG. 6

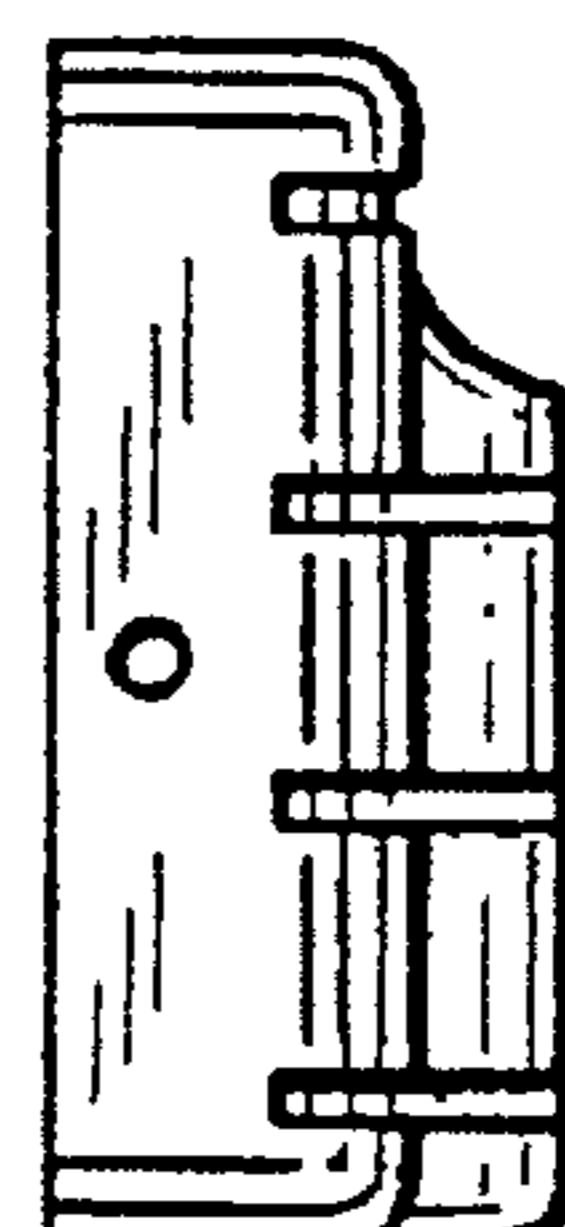

FIG. 7

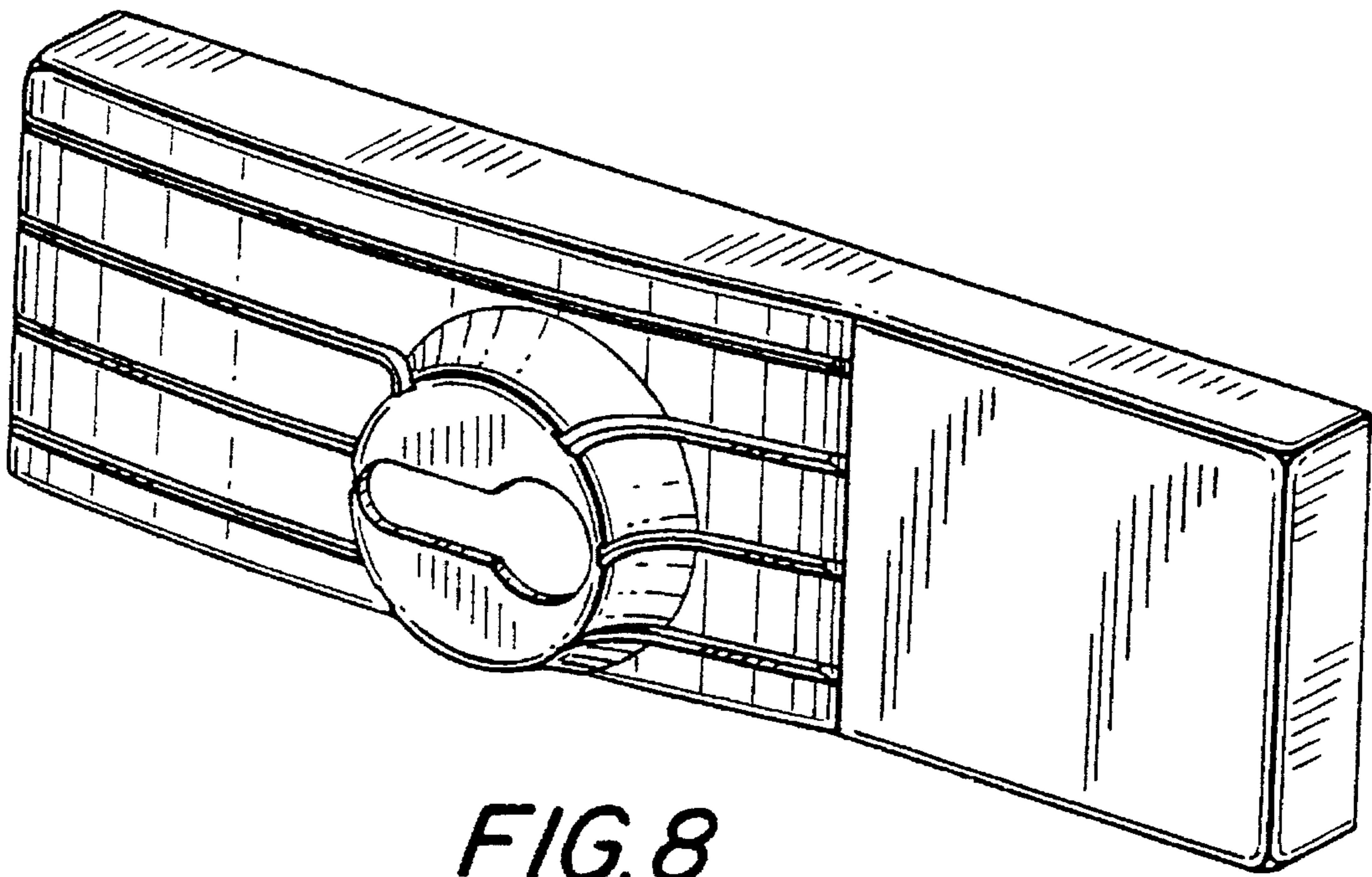
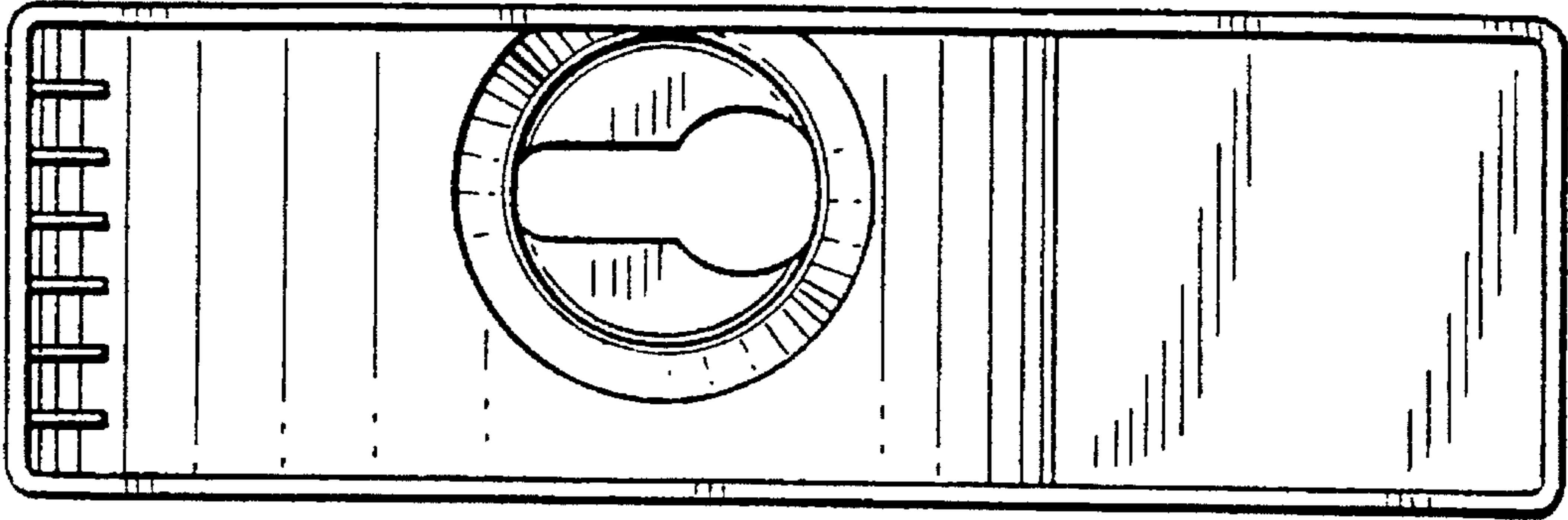

FIG. 8

FIG. 9

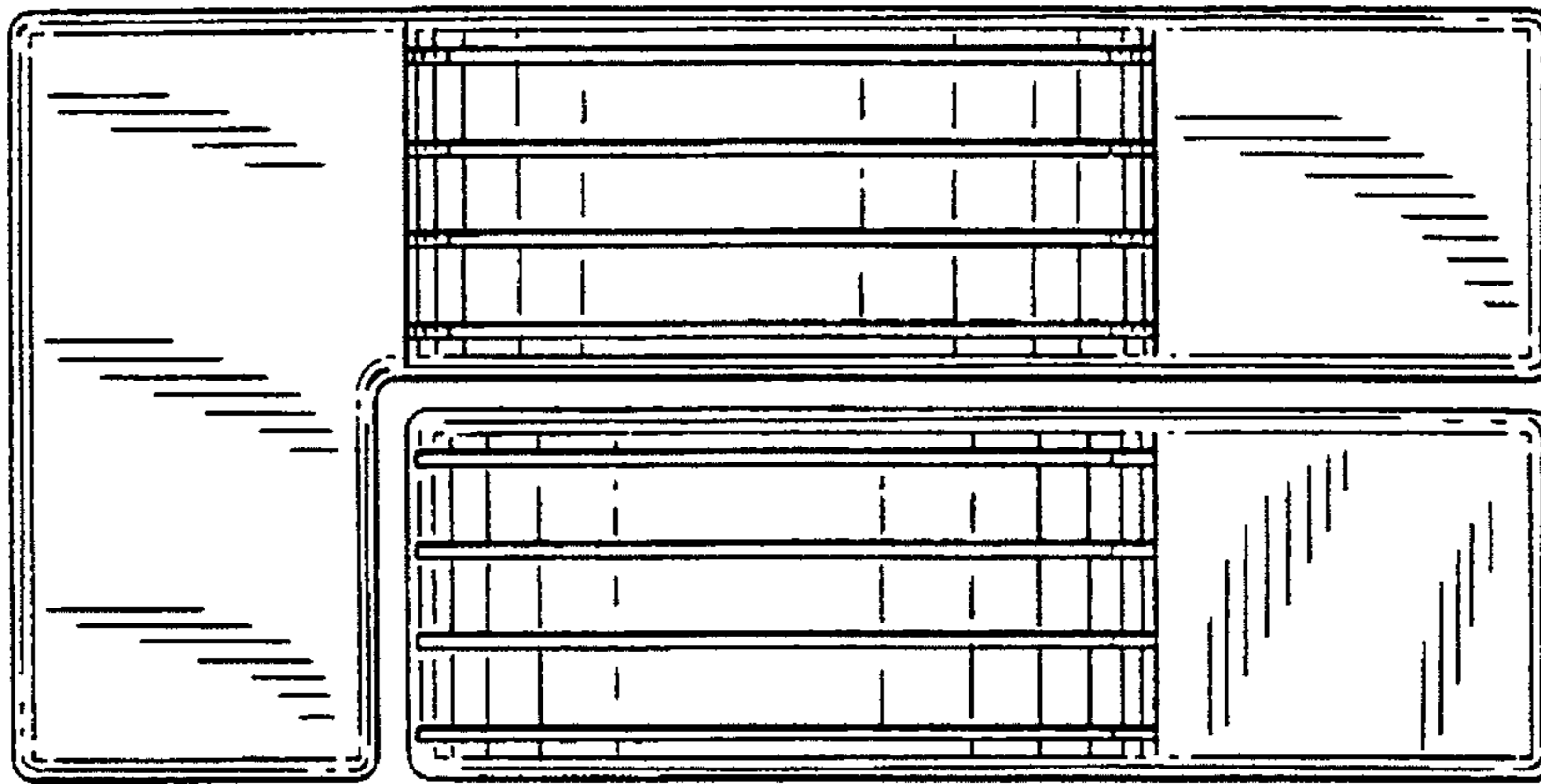

FIG. 10

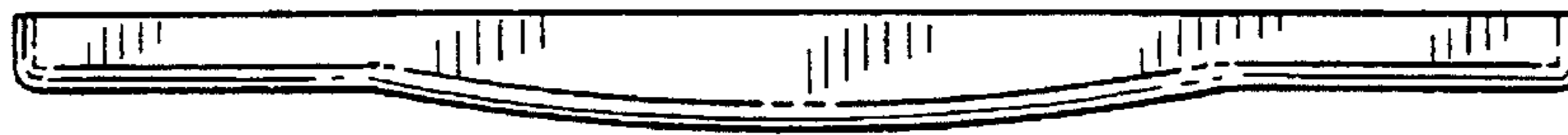

FIG. 11



FIG. 12

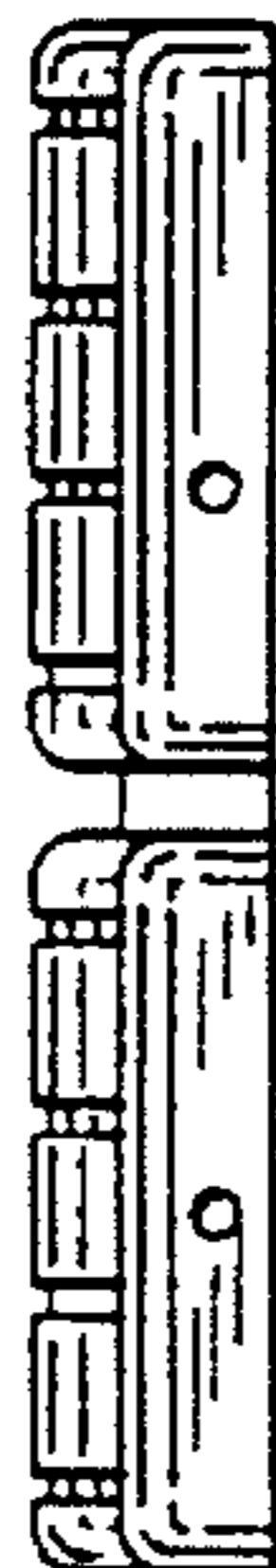

FIG. 13



FIG. 14

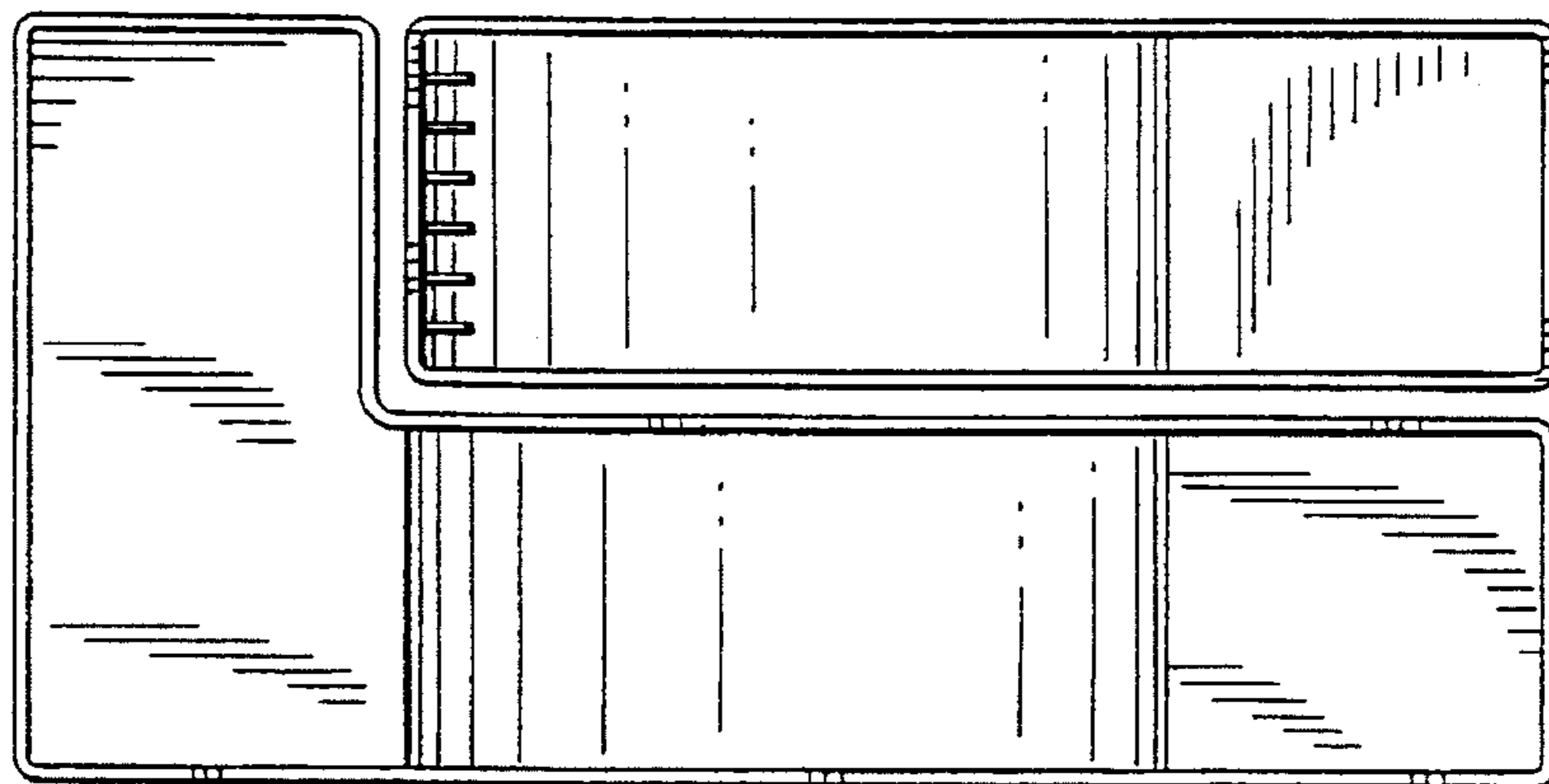

FIG. 15

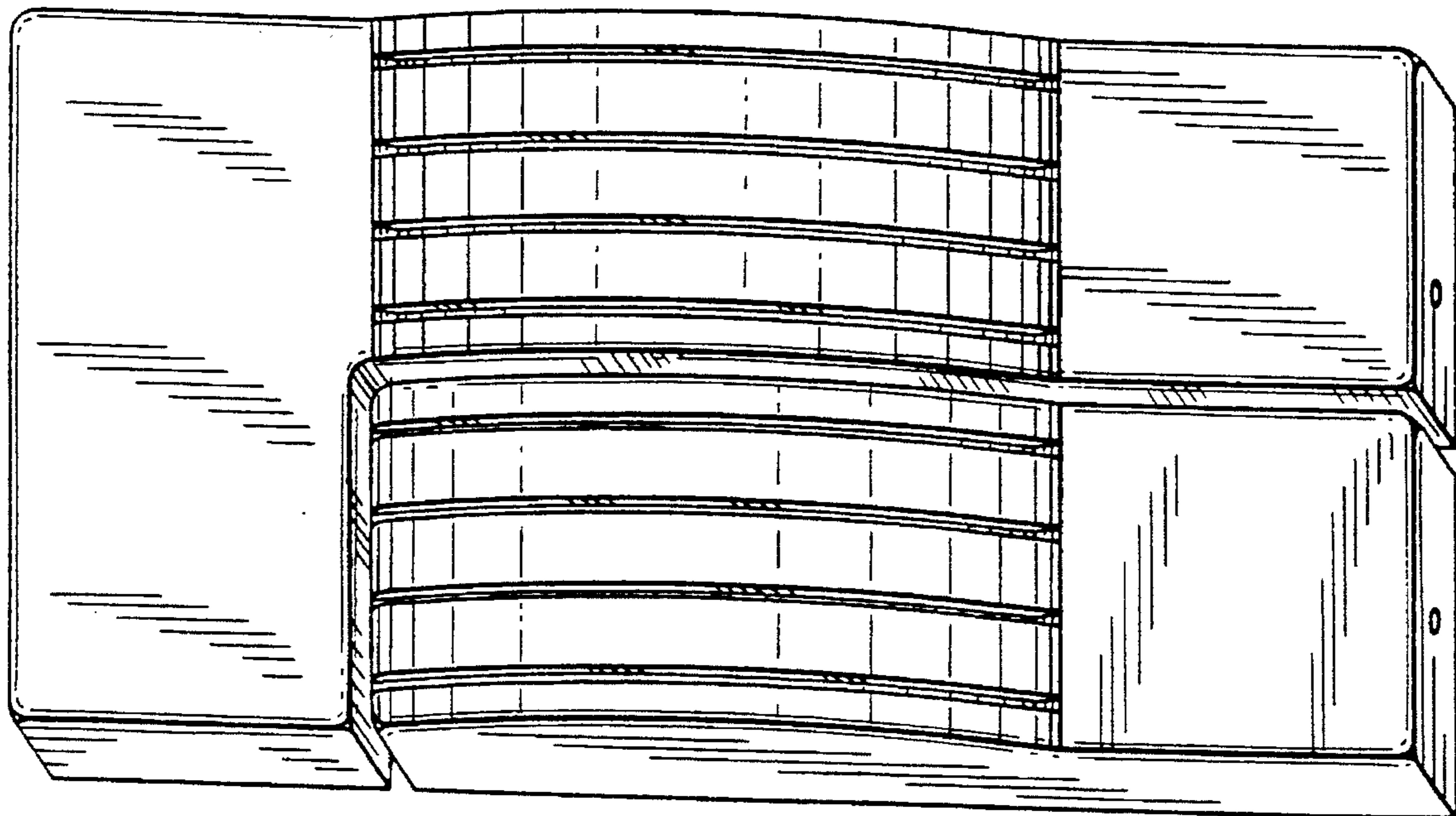

FIG. 16

