

US00D378494S

United States Patent [19]
Miller

[11] **Patent Number: Des. 378,494**

[45] **Date of Patent: **Mar. 18, 1997**

[54] **CORNER POUR CONTAINER**
[75] Inventor: **Wallace A. Miller**, Cincinnati, Ohio
[73] Assignee: **SST Industries, Inc.**, Loveland, Ohio
[**] Term: **14 Years**

4,541,529 9/1985 Hestehave et al. 206/510
4,881,647 11/1989 Schiemann 206/510
5,114,028 5/1992 Ring 215/100
5,265,743 11/1993 Frohn 215/10
5,299,710 4/1994 Welsch et al. 215/382 X

FOREIGN PATENT DOCUMENTS

0235348 8/1986 European Pat. Off. .
0266851 11/1987 European Pat. Off. .
3224038 12/1983 Germany .
87004453 10/1987 Germany .
2166706 5/1986 United Kingdom 220/768

[21] Appl. No.: **49,970**
[22] Filed: **Feb. 5, 1996**
[52] **U.S. Cl.** **D9/528**
[58] **Field of Search** D9/528, 527, 523,
D9/520; D7/312, 313; 215/385, 398, 382-384;
220/768, 771

Primary Examiner—Lucy Lieberman
Attorney, Agent, or Firm—Thompson Hine & Flory L.L.P.

[57] **CLAIM**

The ornamental design for a corner pour container, as shown and described.

[56] **References Cited**

U.S. PATENT DOCUMENTS

D. 59,407 10/1921 Brown .
D. 168,889 2/1953 Gardner D58/12
D. 207,243 3/1967 Kelly D9/528
D. 219,867 2/1971 Reimer D9/528 X
D. 242,324 11/1976 Gartin D9/1
D. 252,257 7/1979 Dobbs et al. D9/52
D. 273,661 5/1984 Widmer D9/527
D. 277,252 2/1985 Küng D9/376
D. 305,981 2/1990 Levee D9/374
D. 335,745 5/1993 Schilthuizen D9/528 X
D. 354,414 1/1995 Westgerdes D7/313
D. 357,417 4/1995 Van Keimpema et al. D9/520
3,400,846 9/1968 Kelly 215/398
3,765,574 10/1973 Urquiza 215/384 X
4,351,454 9/1982 Maynard, Jr. 222/143

DESCRIPTION

FIG. 1 is a perspective view of my new corner pour container taken from above;
FIG. 2 is a top plan view thereof;
FIG. 3 is a front elevational view thereof;
FIG. 4 is a left side elevational view thereof, the right side being a mirror image thereof;
FIG. 5 is a bottom plan view thereof;
FIG. 6 is a rear elevational view thereof; and,
FIG. 7 is a cross-sectional view thereof taken along line 7—7 of FIG. 2.

1 Claim, 4 Drawing Sheets

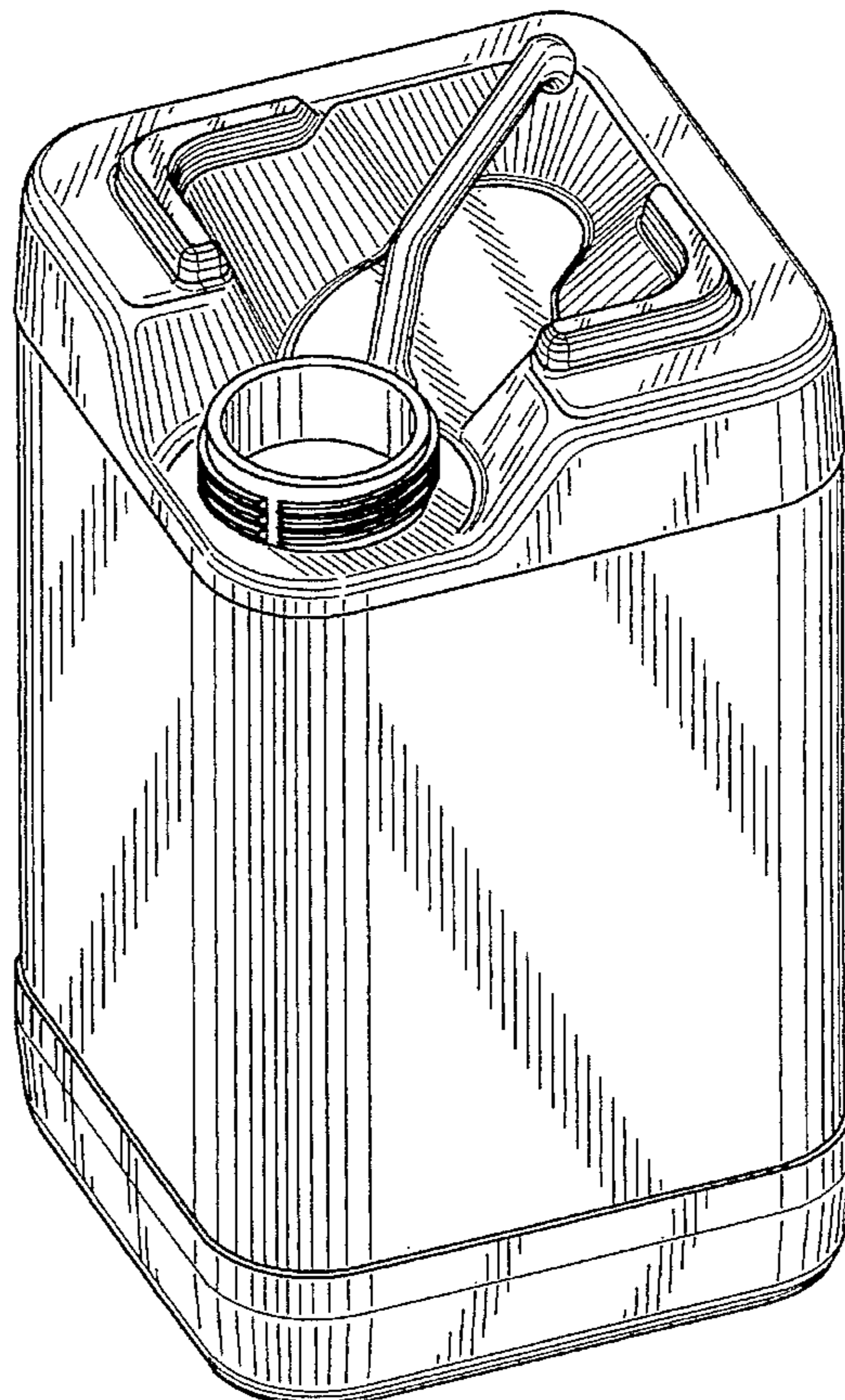

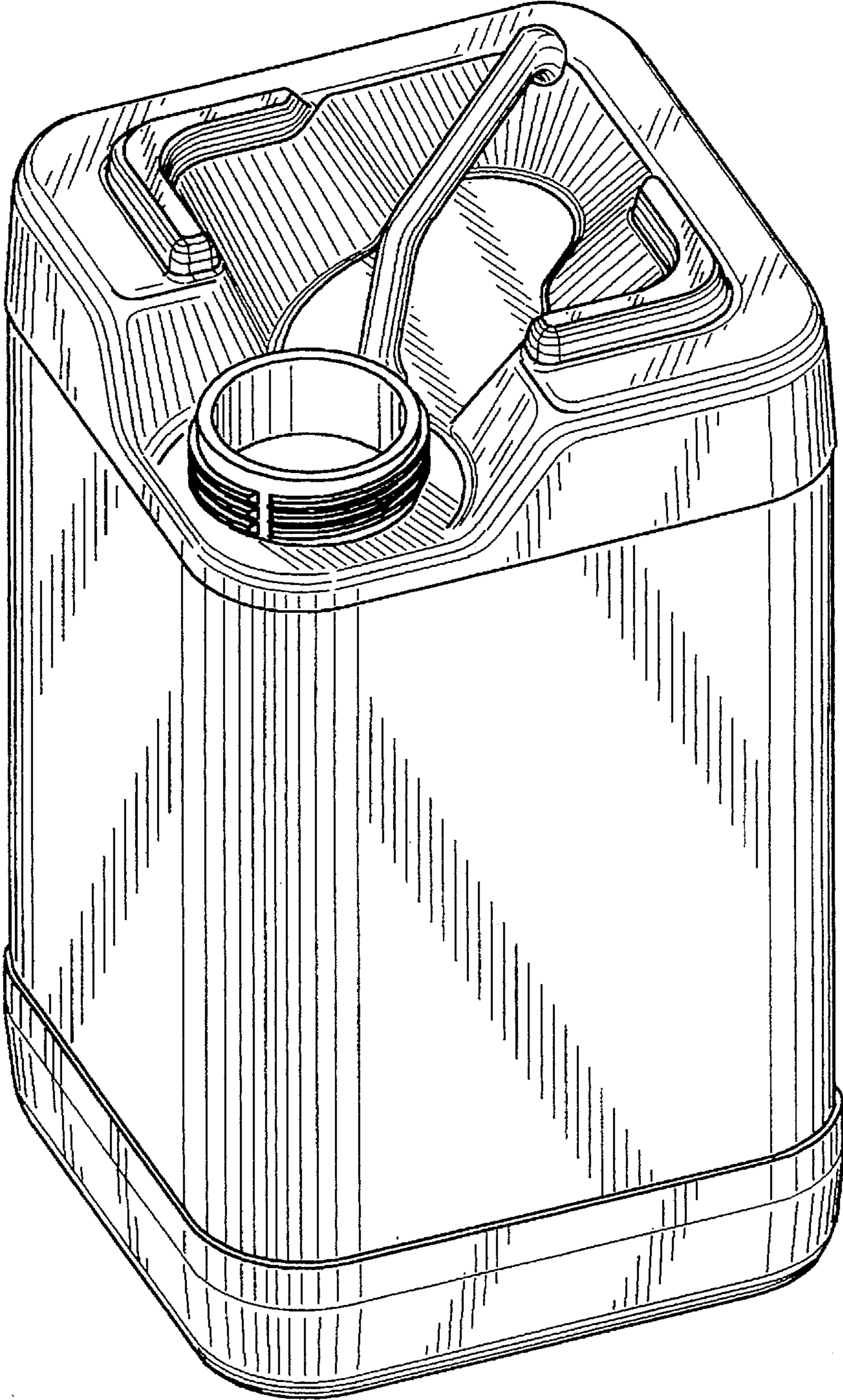

FIG. 1

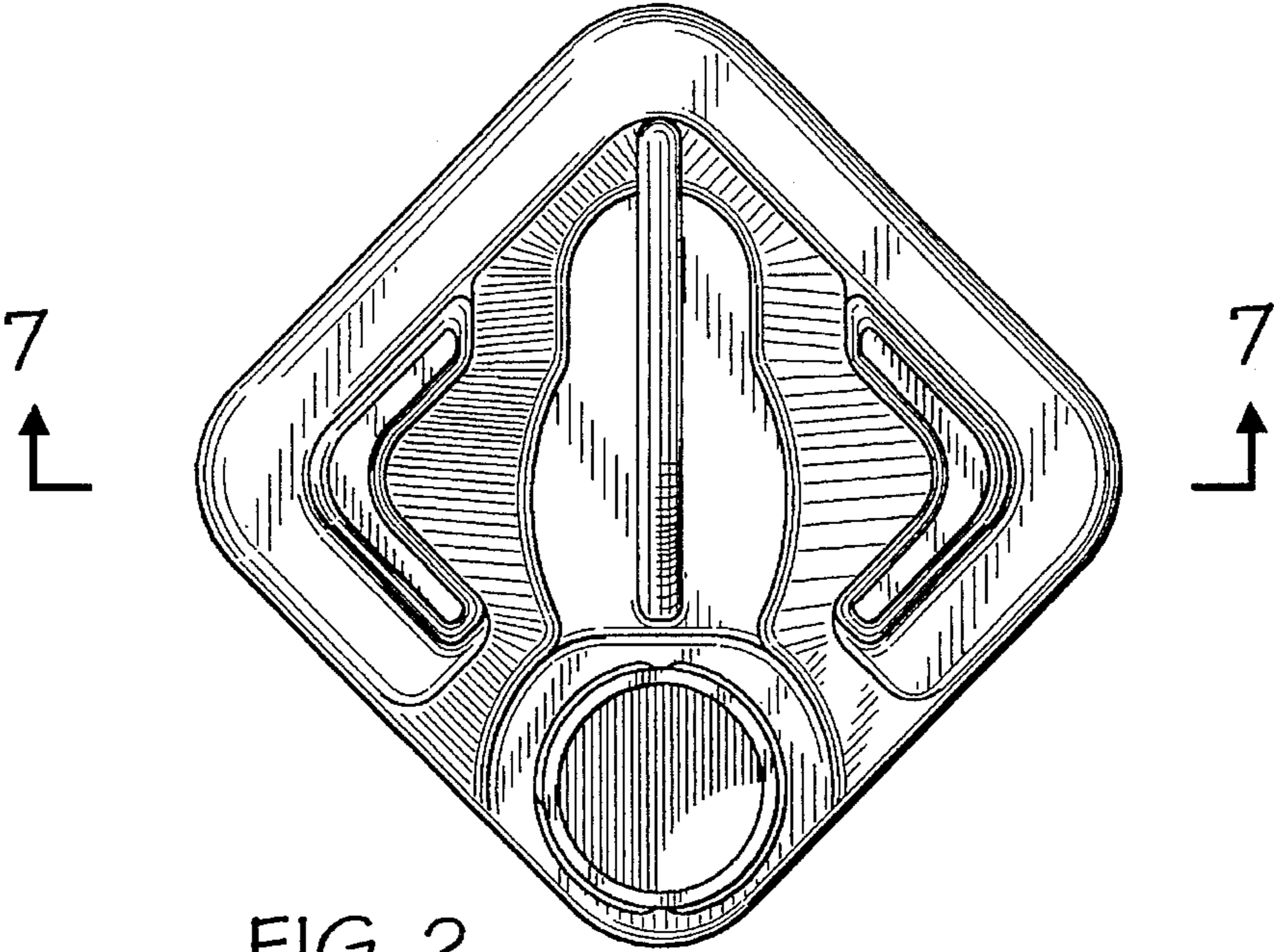

FIG. 2

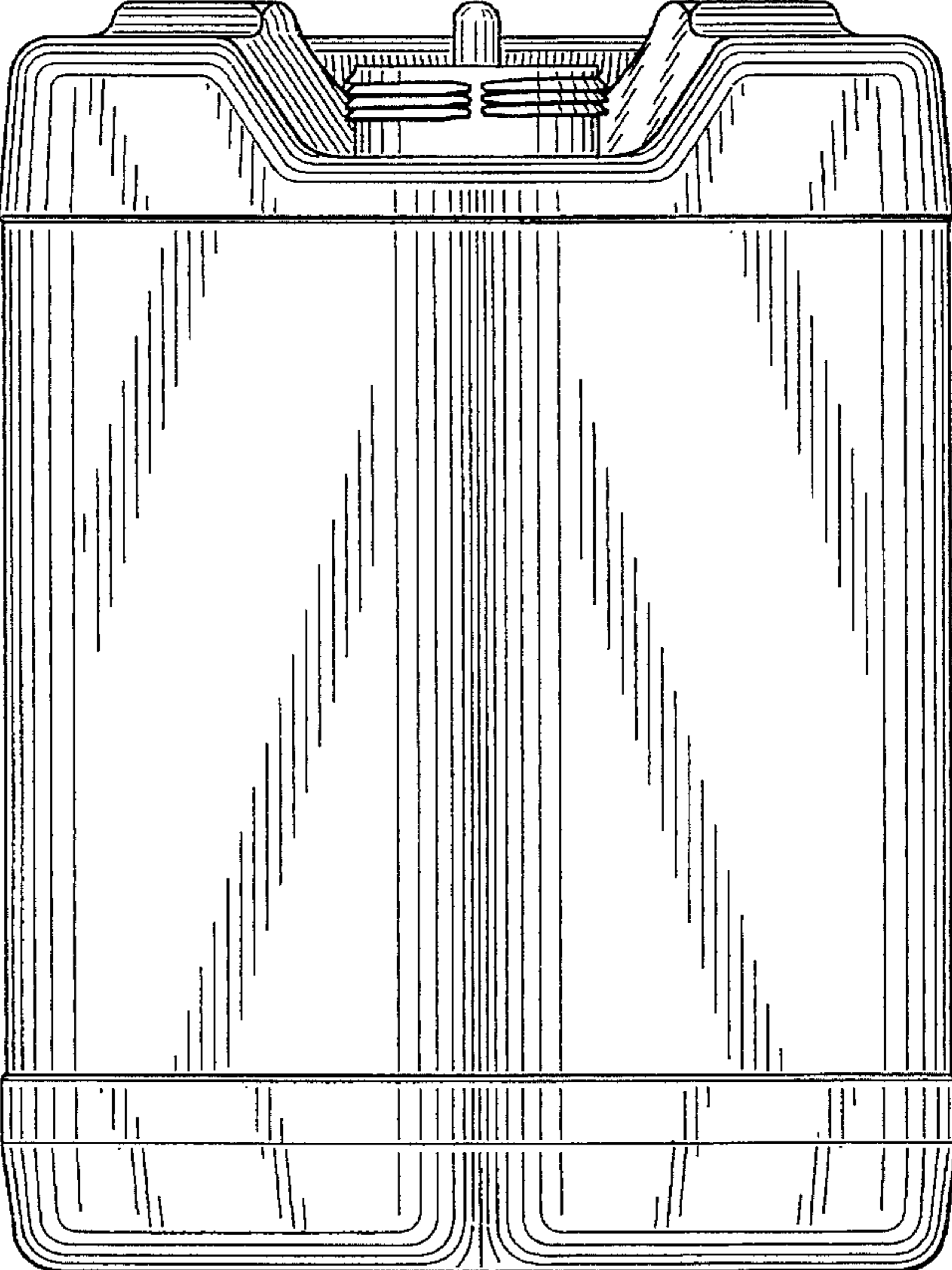

FIG. 3

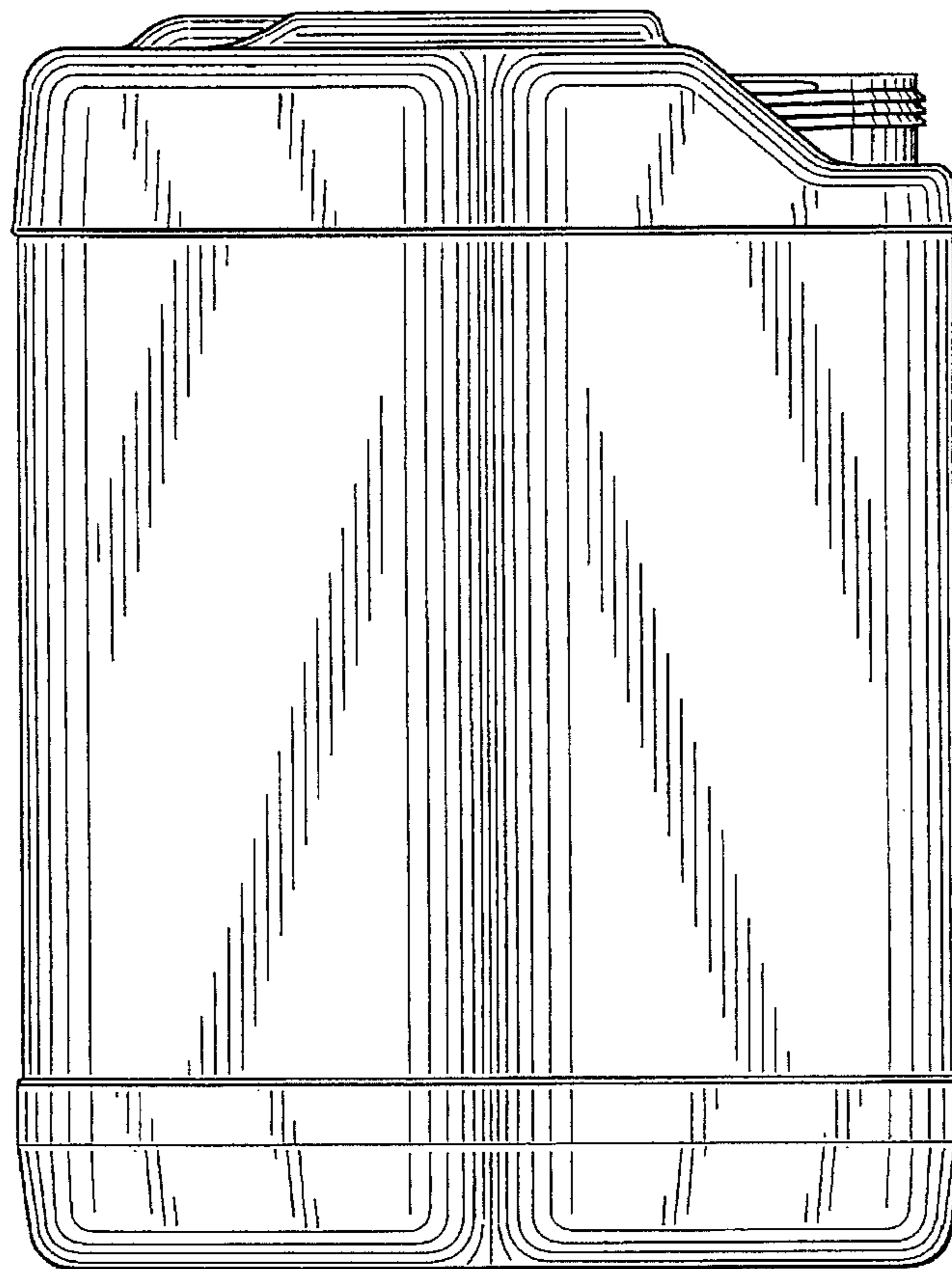

FIG. 4

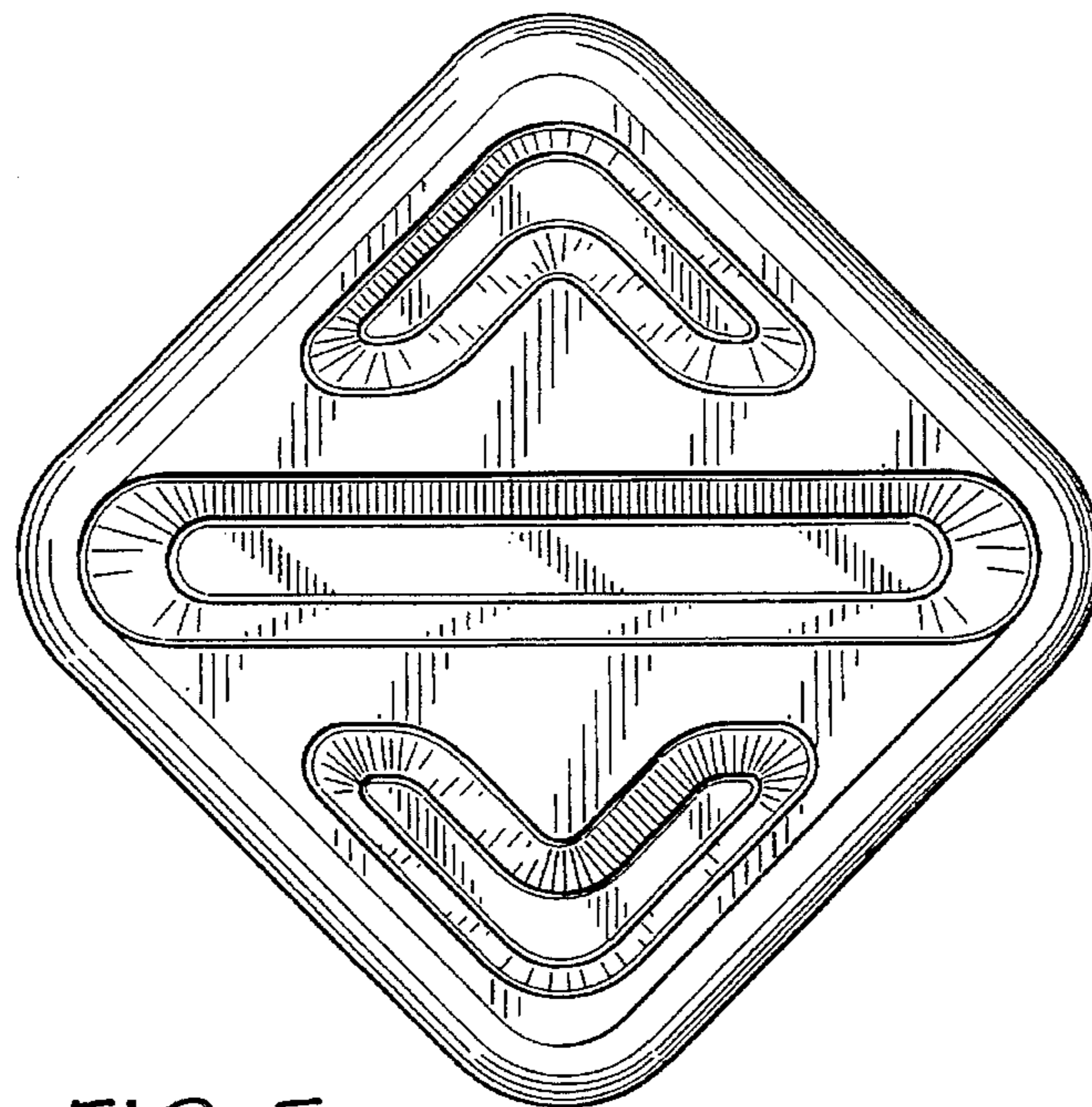

FIG. 5

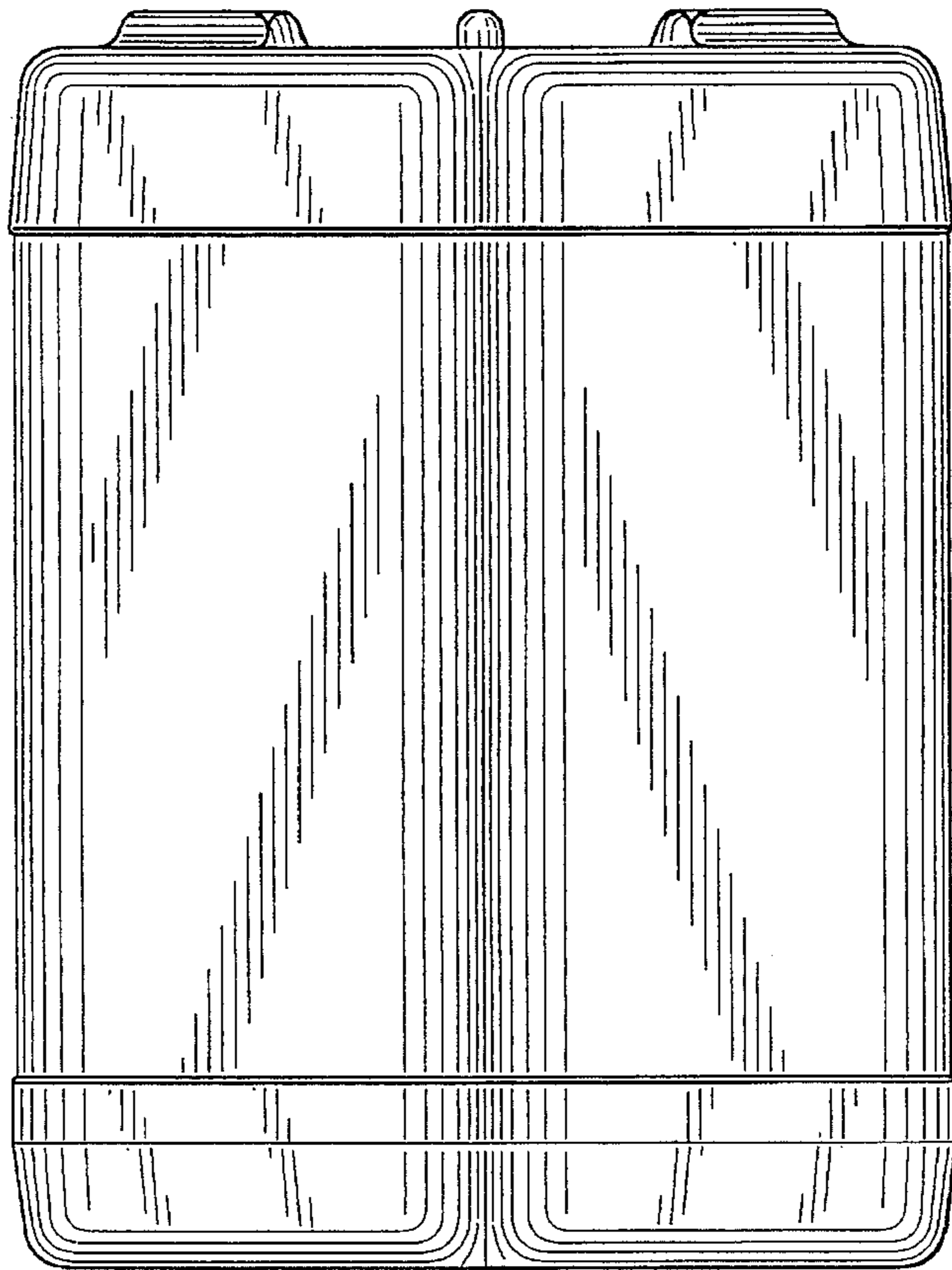

FIG. 6

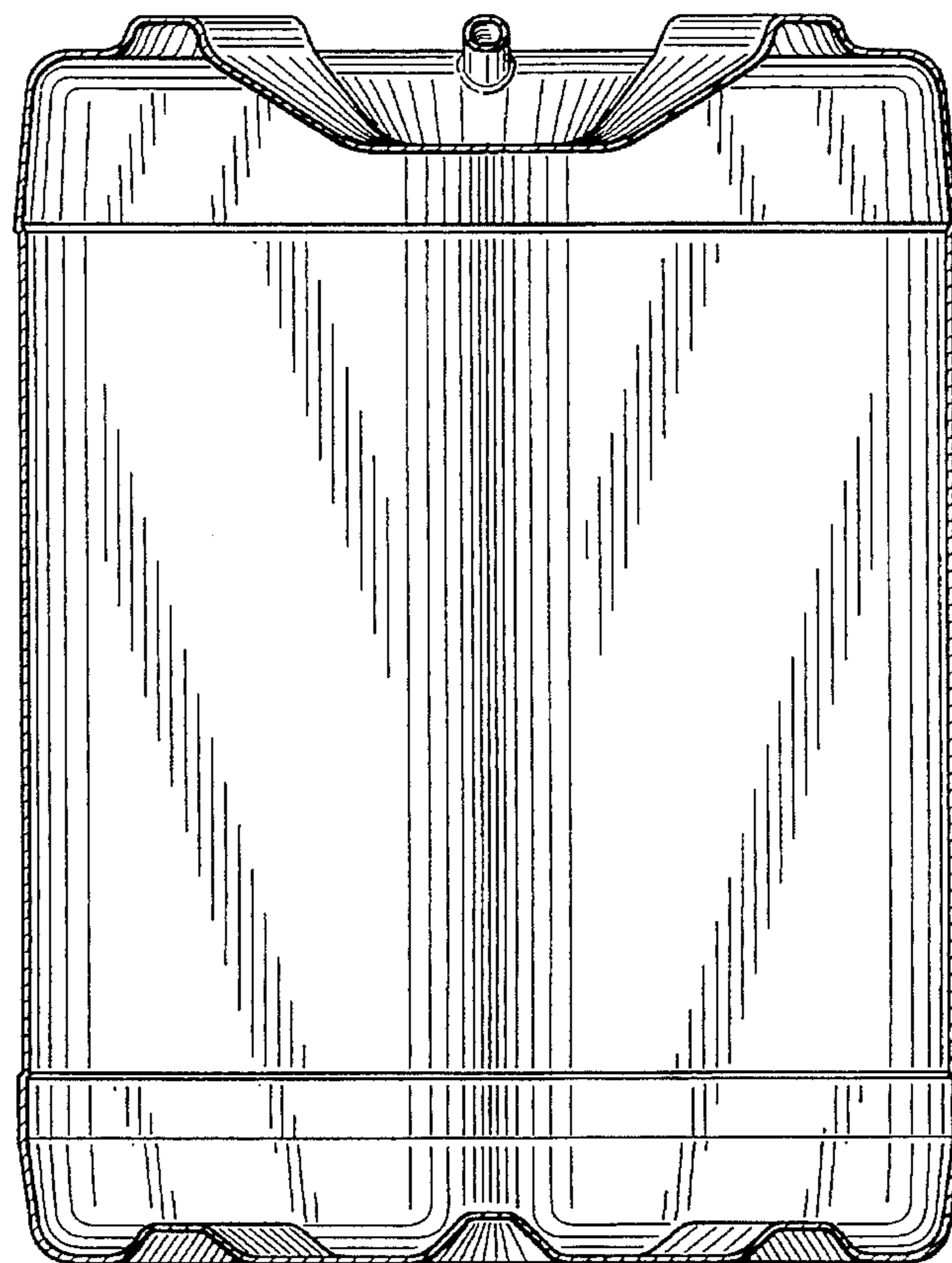

FIG. 7