



US00D378464S

United States Patent [19]

[11] Patent Number: **Des. 378,464**

Perkitny

[45] Date of Patent: ****Mar. 11, 1997**

[54] COIN BANK

3,338,250	8/1967	Mehelich	232/5
4,871,055	10/1989	Poythress et al.	D99/35
5,122,093	6/1992	Perkitny	446/9

[76] Inventor: **Jerzy Perkitny**, 28115 Osborn, Bay Village, Ohio 44140

OTHER PUBLICATIONS

[**] Term: **14 Years**

Money Wrapper Bank, *The Paragon Gift Catalog*.

[21] Appl. No.: **28,531**

Primary Examiner—B. J. Bullock

[22] Filed: **Sep. 16, 1994**

Assistant Examiner—Robert M. Spear

[52] U.S. Cl. **D99/34**

Attorney, Agent, or Firm—Watts, Hoffmann, Fisher & Heinke Co.

[58] Field of Search D6/557; D9/311, D9/317; D11/160, 162; D21/150, 151, 160, 166; D99/34, 35, 37, 38, 39; 232/1 D, 5, 14, 15; 446/9, 10, 11, 12

[57] CLAIM

The ornamental design for a coin bank, as shown.

DESCRIPTION

[56] References Cited

FIG. 1 is a perspective view of a coin bank showing my new design;

U.S. PATENT DOCUMENTS

- D. 239,960 5/1976 Miyazaki et al. .
- D. 241,866 10/1976 Miyazaki et al. .
- D. 270,868 10/1983 Spirk, Jr. et al. .
- D. 283,075 3/1986 Spirk, Jr. et al. .
- D. 288,499 2/1987 Wan .
- D. 296,029 5/1988 Knox .
- D. 347,929 6/1994 Perkitny .
- D. 359,152 6/1995 Adams et al. D99/34

FIG. 2 is a left side elevational view of the coin bank;

FIG. 3 is a right side elevational view of the coin bank;

FIG. 4 is a front elevational view of the coin bank;

FIG. 5 is a rear elevational view of the coin bank;

FIG. 6 is a top plan view of the coin bank; and,

FIG. 7 is a bottom plan view of the coin bank.

1 Claim, 6 Drawing Sheets

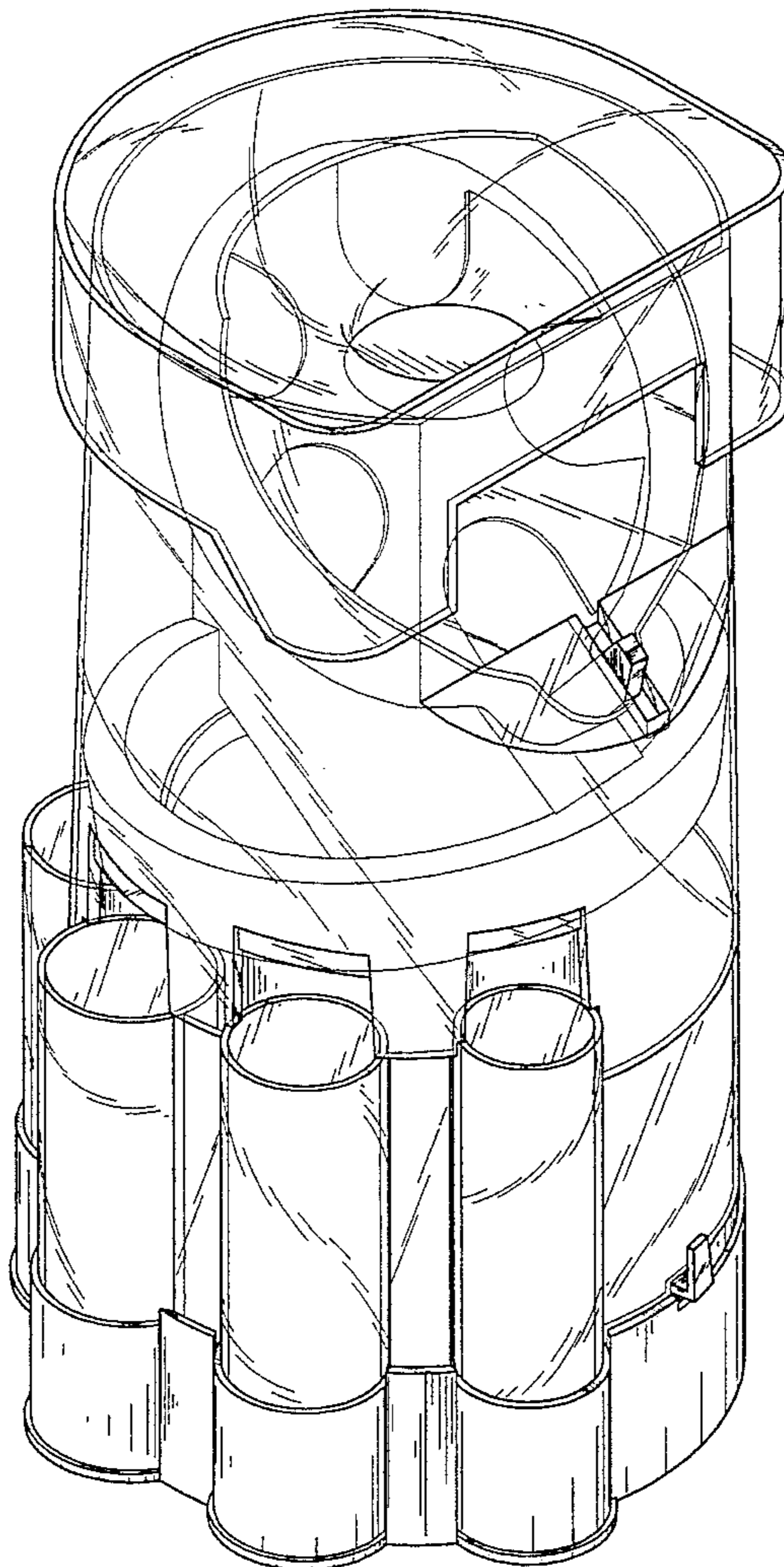

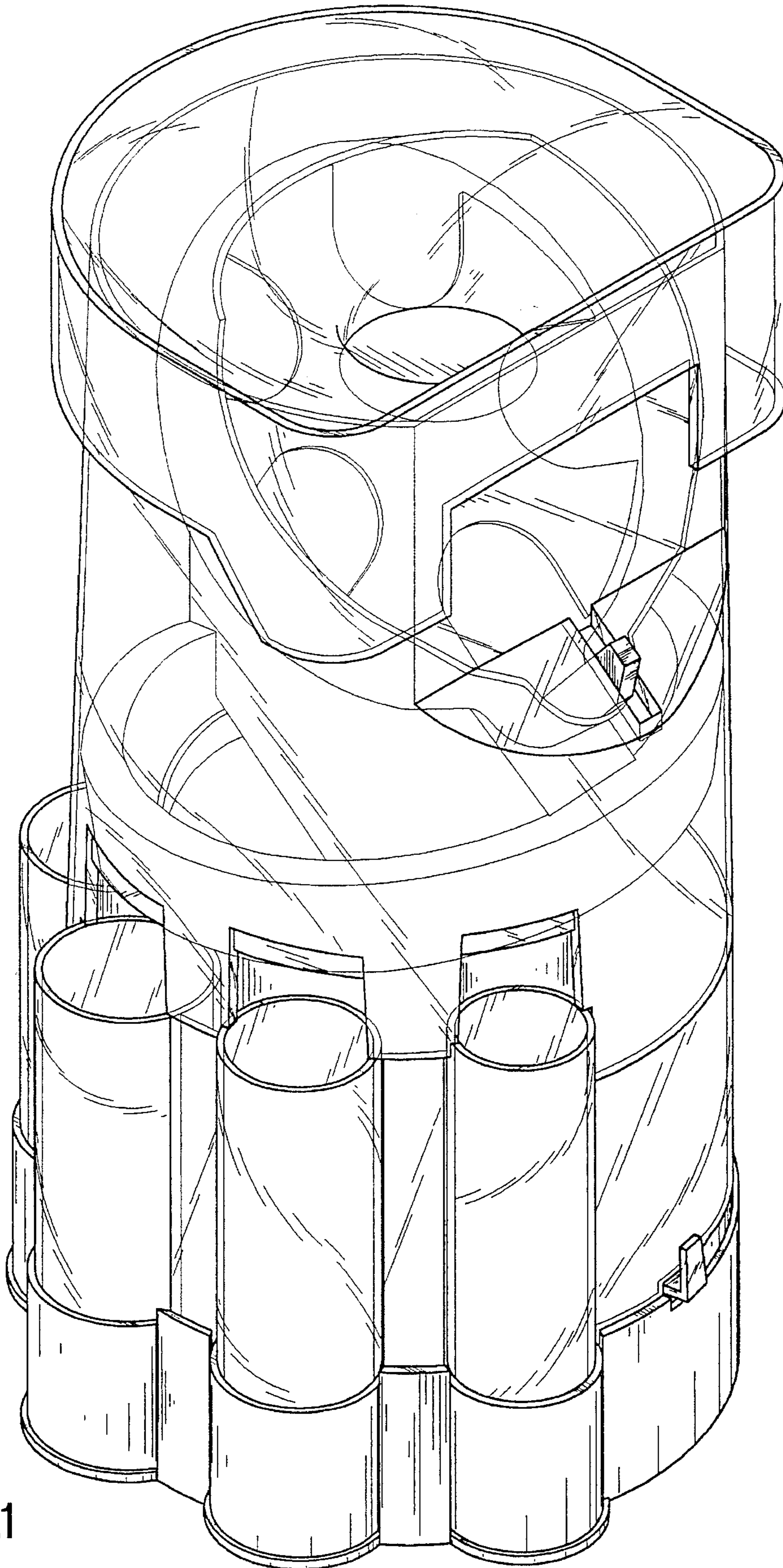

Fig.1

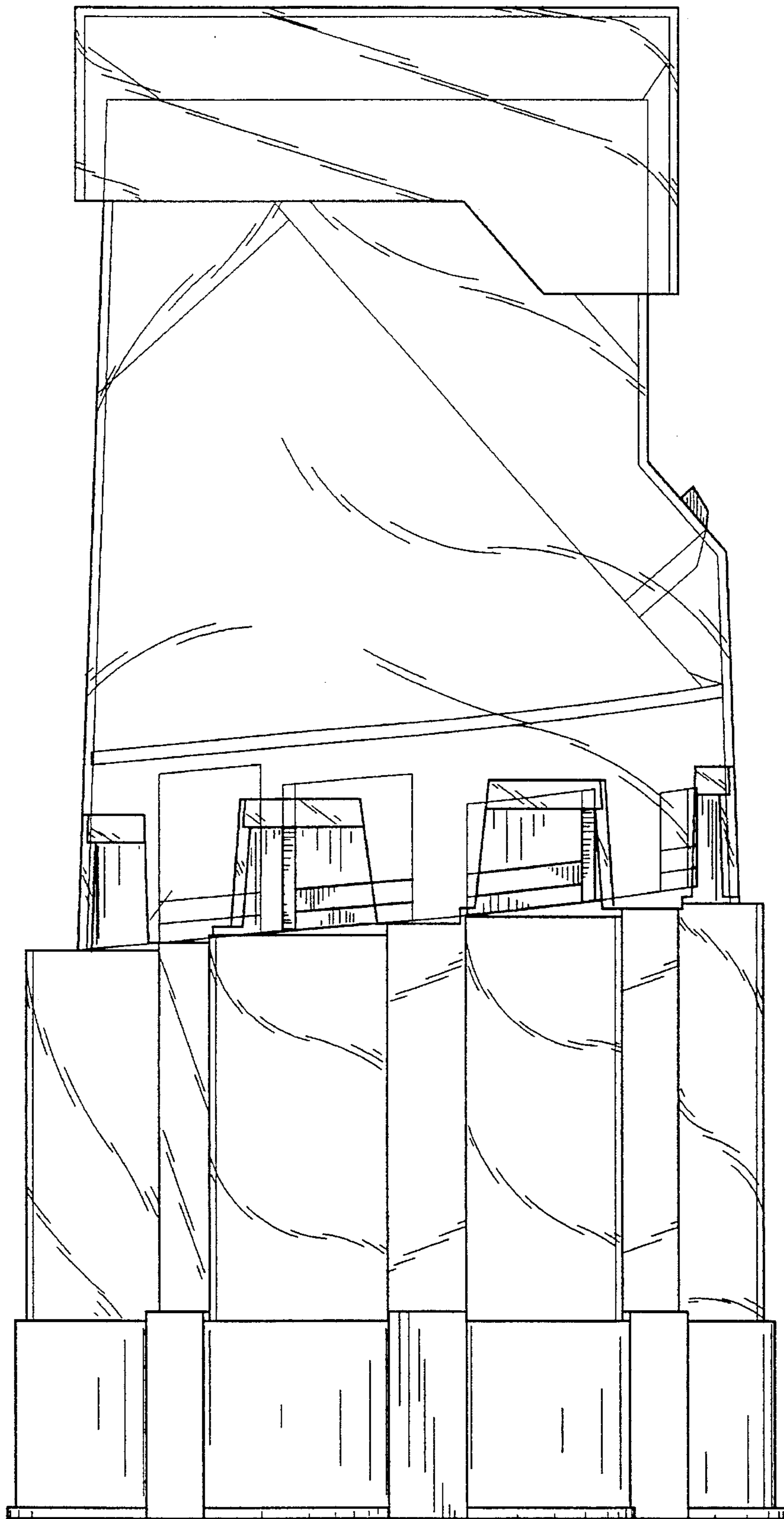

Fig.2

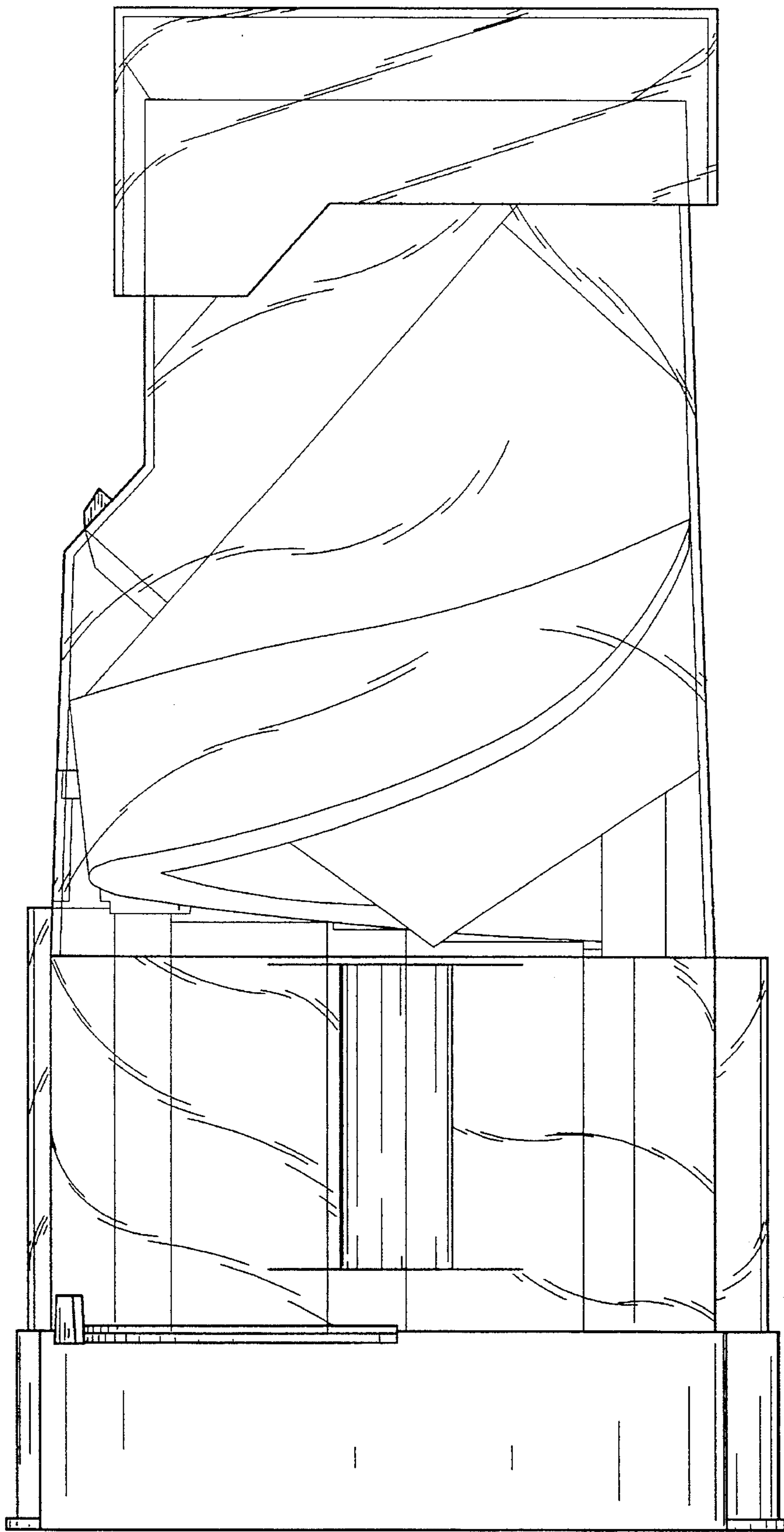

Fig.3

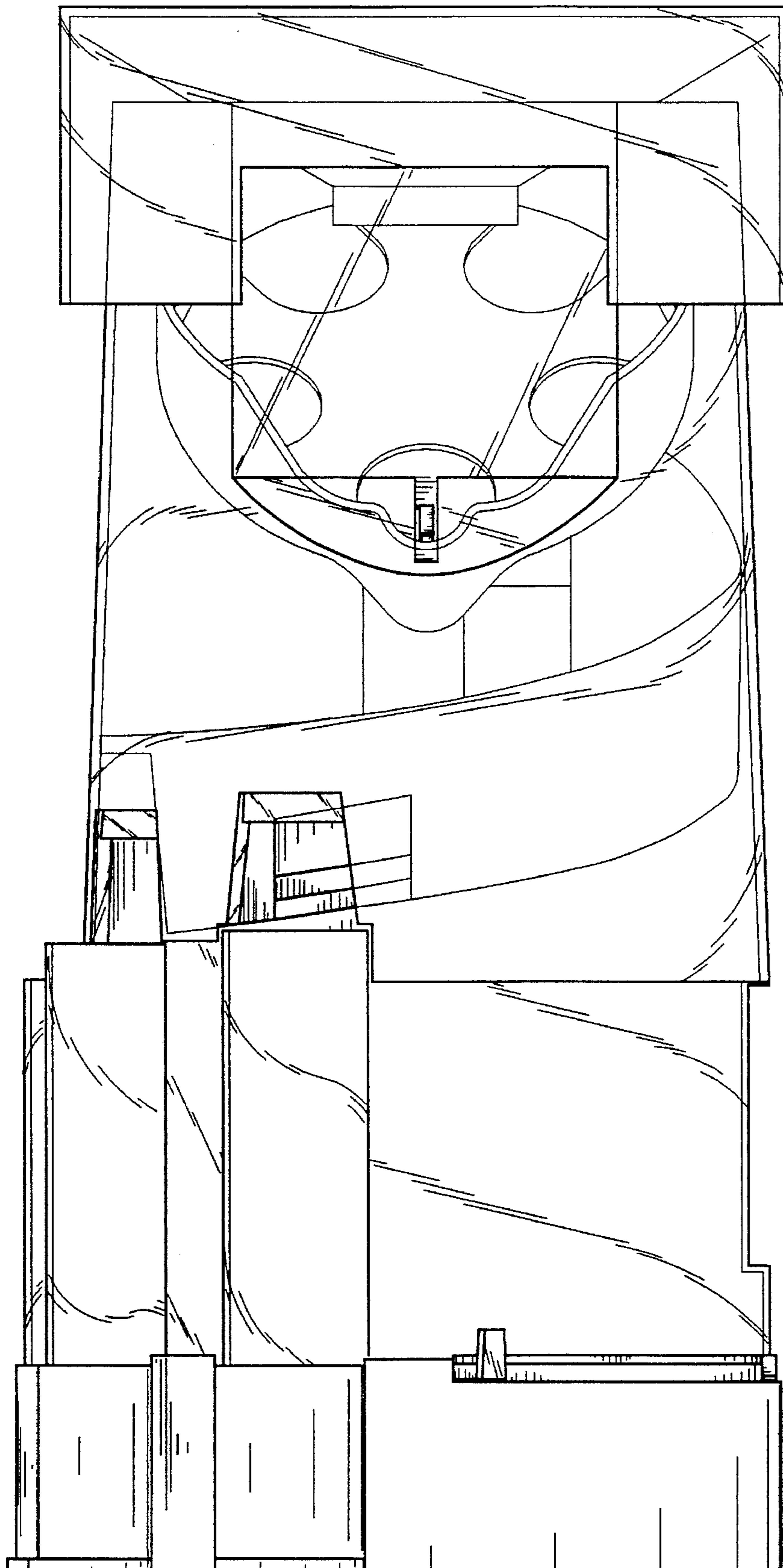

Fig.4

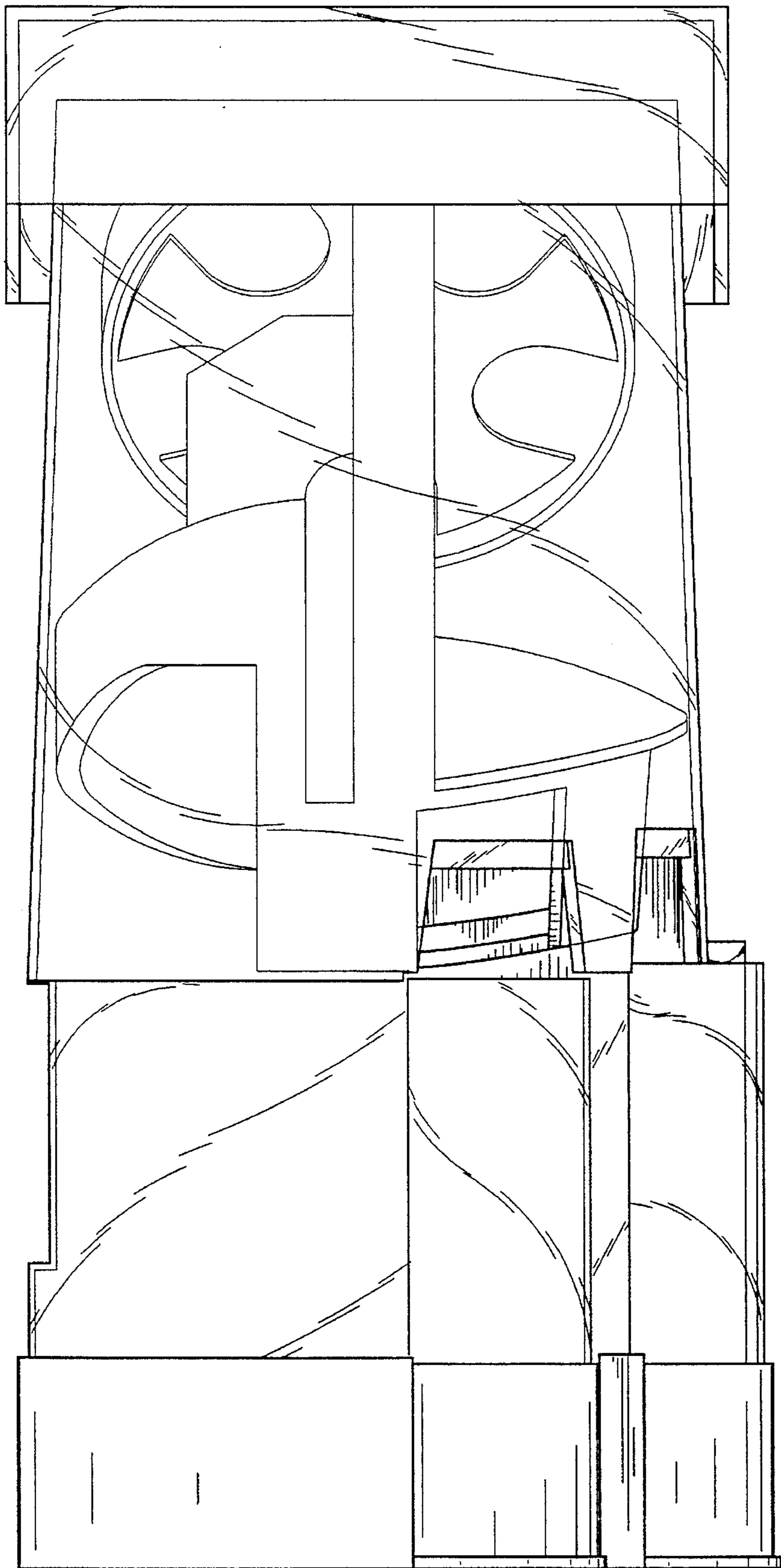

Fig.5

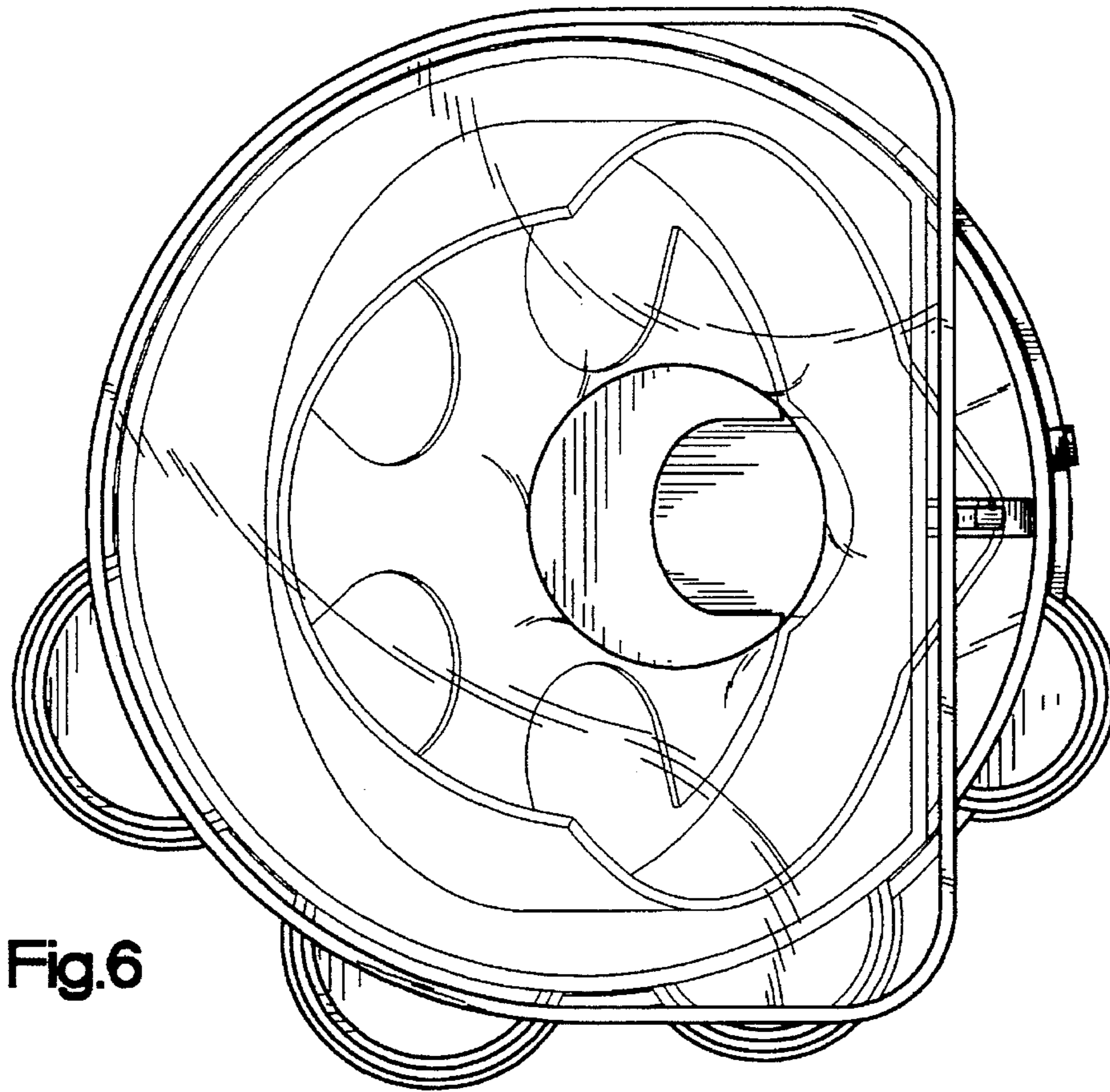

Fig.6

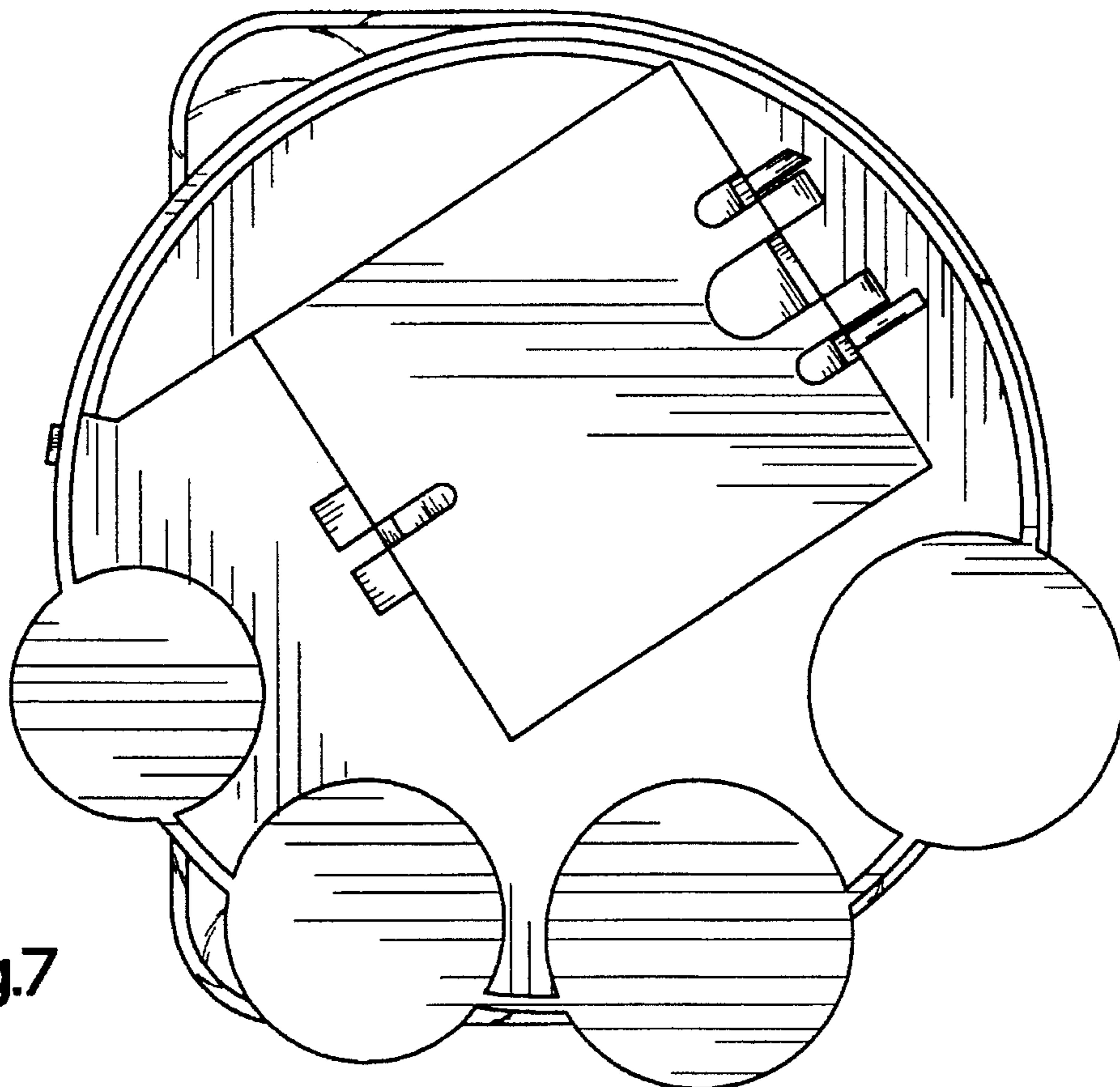

Fig.7