



US00D378434S

# United States Patent [19]

[11] Patent Number: **Des. 378,434**

Petterson et al.

[45] Date of Patent: **\*\*Mar. 11, 1997**

[54] FLASHLIGHT

Primary Examiner—Marcus A. Jackson

[75] Inventors: **Tor H. Petterson**, Rancho Palos Verdes, Calif.; **Jean T. McGregor**, Algonquin, Ill.

Attorney, Agent, or Firm—Grady J. Frenchick; Stroud, Stroud, Willink, Thompson & Howard

[73] Assignee: **Rayovac Corporation**, Madison, Wis.

[57] **CLAIM**

[\*\*] Term: **14 Years**

The ornamental design for a flashlight, as shown and described.

[21] Appl. No.: **48,172**

**DESCRIPTION**

[22] Filed: **Dec. 21, 1995**

[52] U.S. Cl. .... **D26/44**

[58] Field of Search ..... D26/37-50; 362/157, 362/158, 171, 172, 178, 181, 183, 192, 194, 196, 197, 200-206

FIG. 1 is a left perspective top view of a flashlight embodying our new design;

FIG. 2 is a top elevational view thereof;

FIG. 3 is a front elevational view thereof;

FIG. 4 is a rear elevational view thereof;

FIG. 5 is a bottom elevational view thereof;

FIG. 6 is a right elevational view thereof;

FIG. 7 is a left elevational view thereof;

FIG. 8 is a right perspective bottom view thereof;

FIG. 9 is a left perspective top view thereof, wherein the swiveling head assembly thereof is in an upwardly oriented position; and,

FIG. 10 is a left perspective top view thereof, wherein the swiveling head assembly thereof is in a downwardly oriented position.

[56] **References Cited**

**U.S. PATENT DOCUMENTS**

D. 298,058	10/1988	Hosick	.....	D26/44
D. 332,320	1/1993	Gammache	.....	D26/44
D. 360,702	7/1995	Bamber	.....	D26/44
699,546	3/1901	Newgold	.....	D26/37
1,124,075	1/1915	Swallow	.....	362/197
1,832,563	11/1931	Kuhn	.....	362/197

**1 Claim, 5 Drawing Sheets**

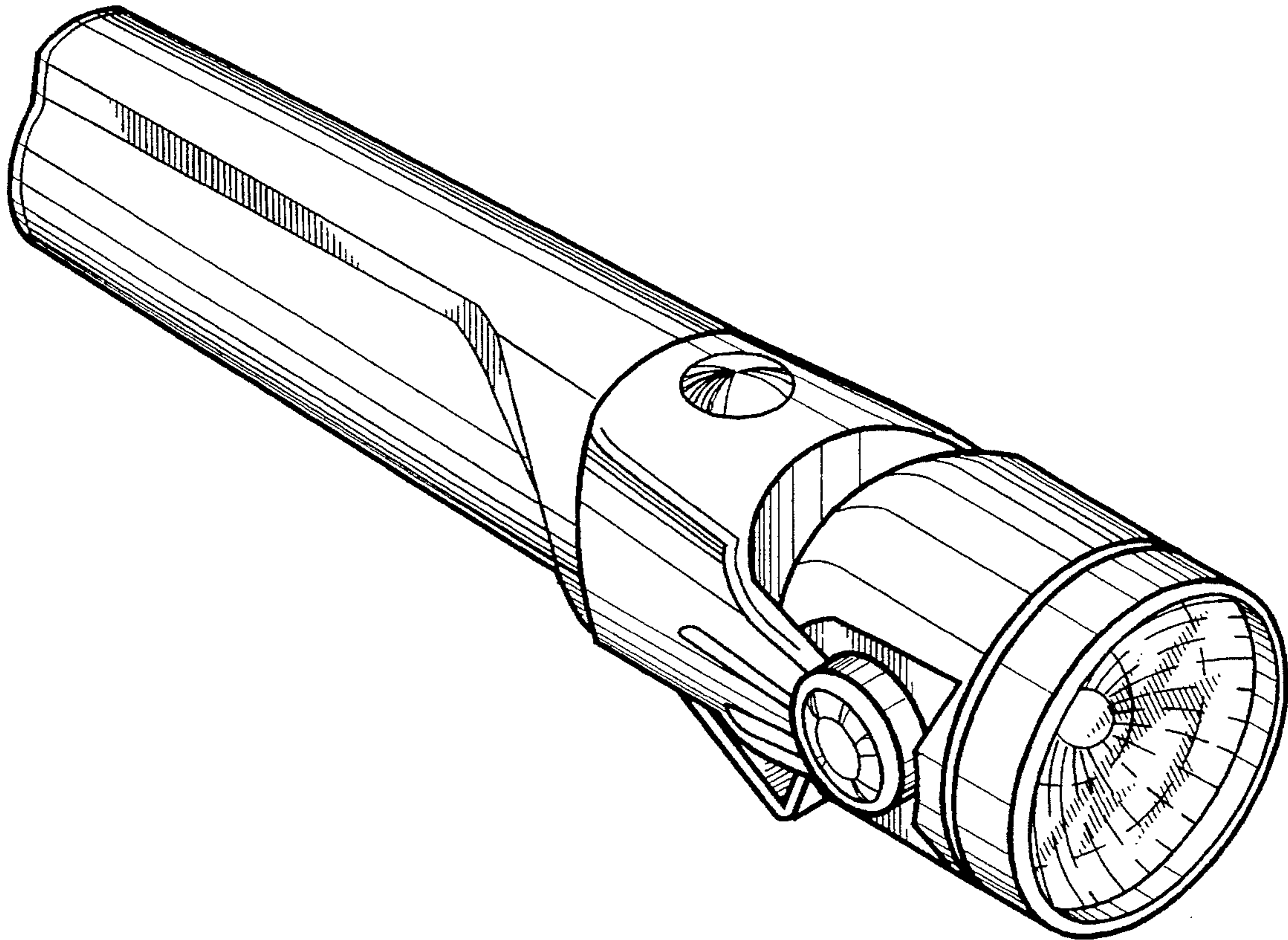

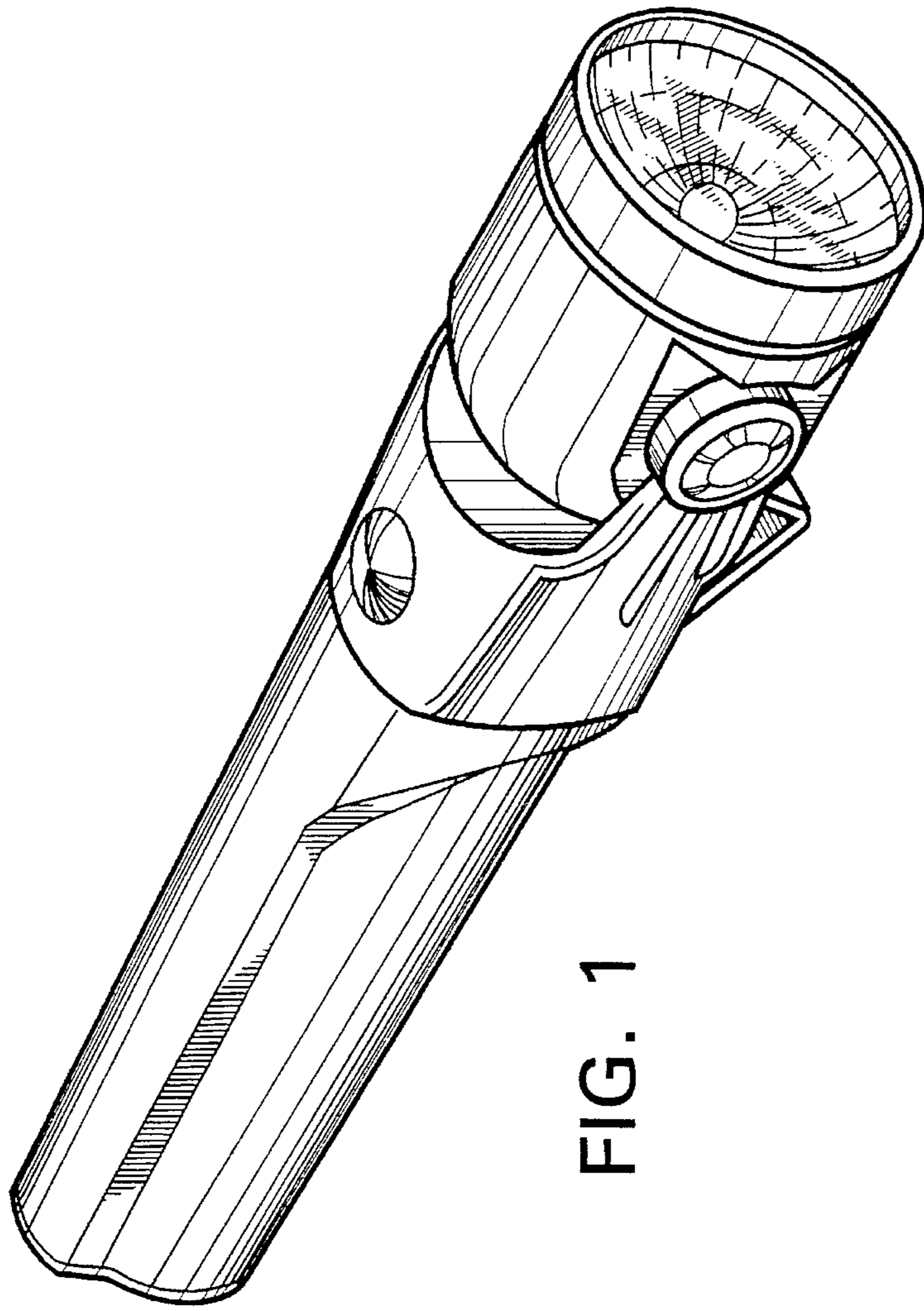

FIG. 1

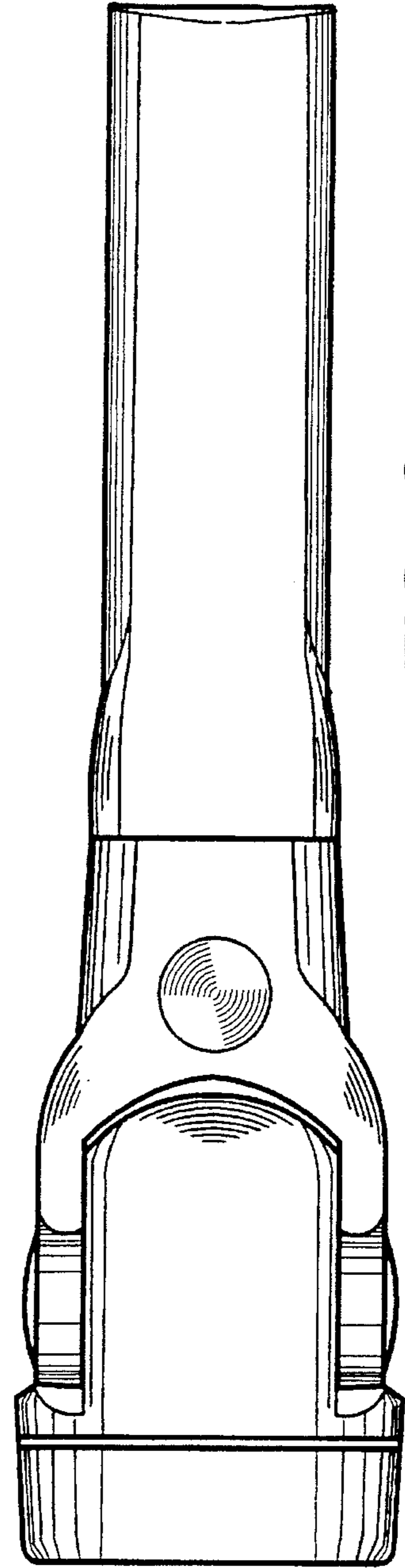

FIG. 2



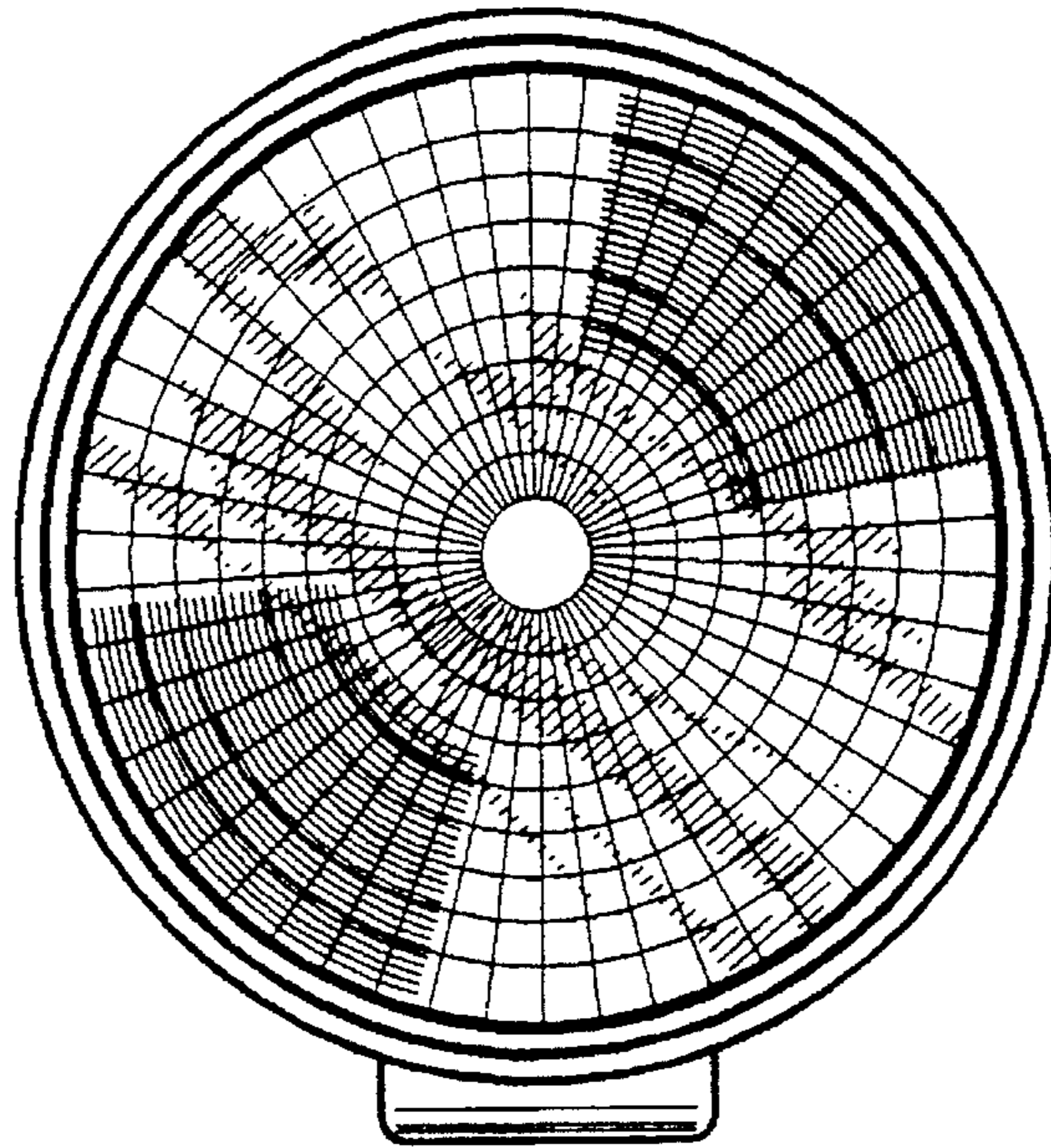

FIG. 3

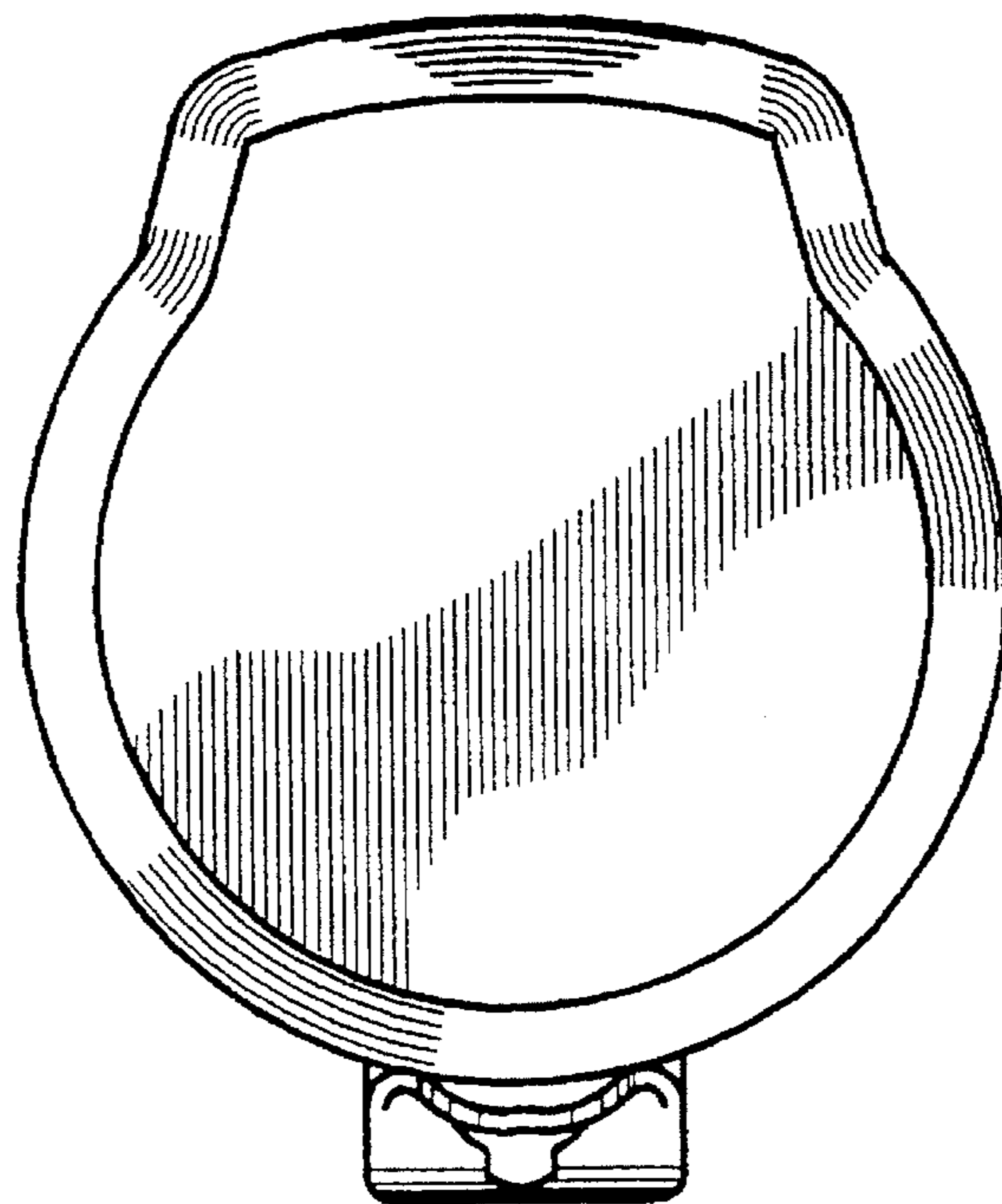

FIG. 4

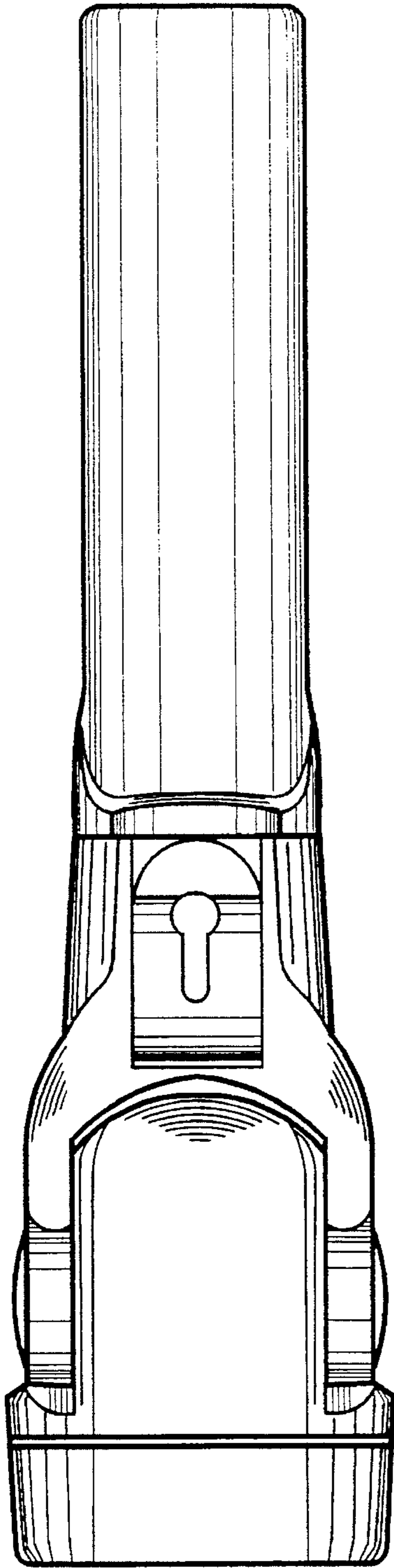

FIG. 5

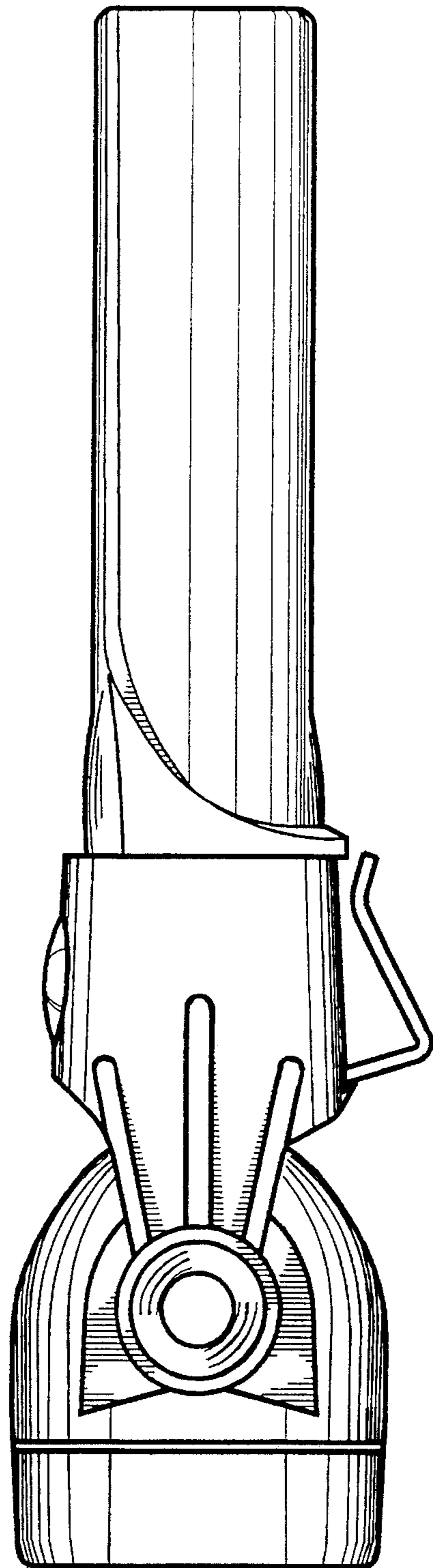

FIG. 6

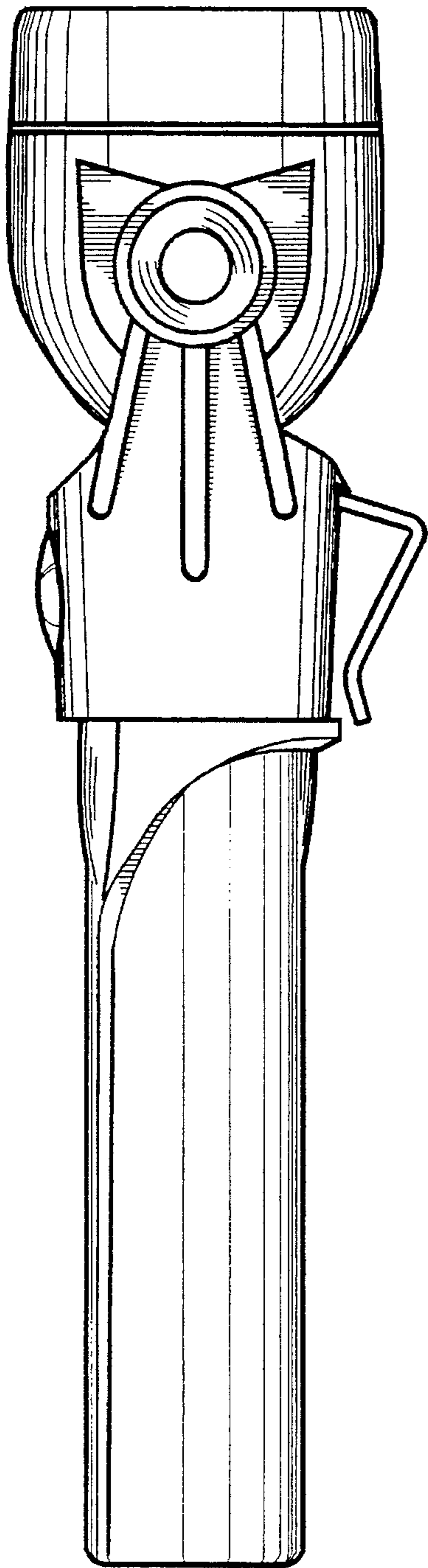

FIG. 7

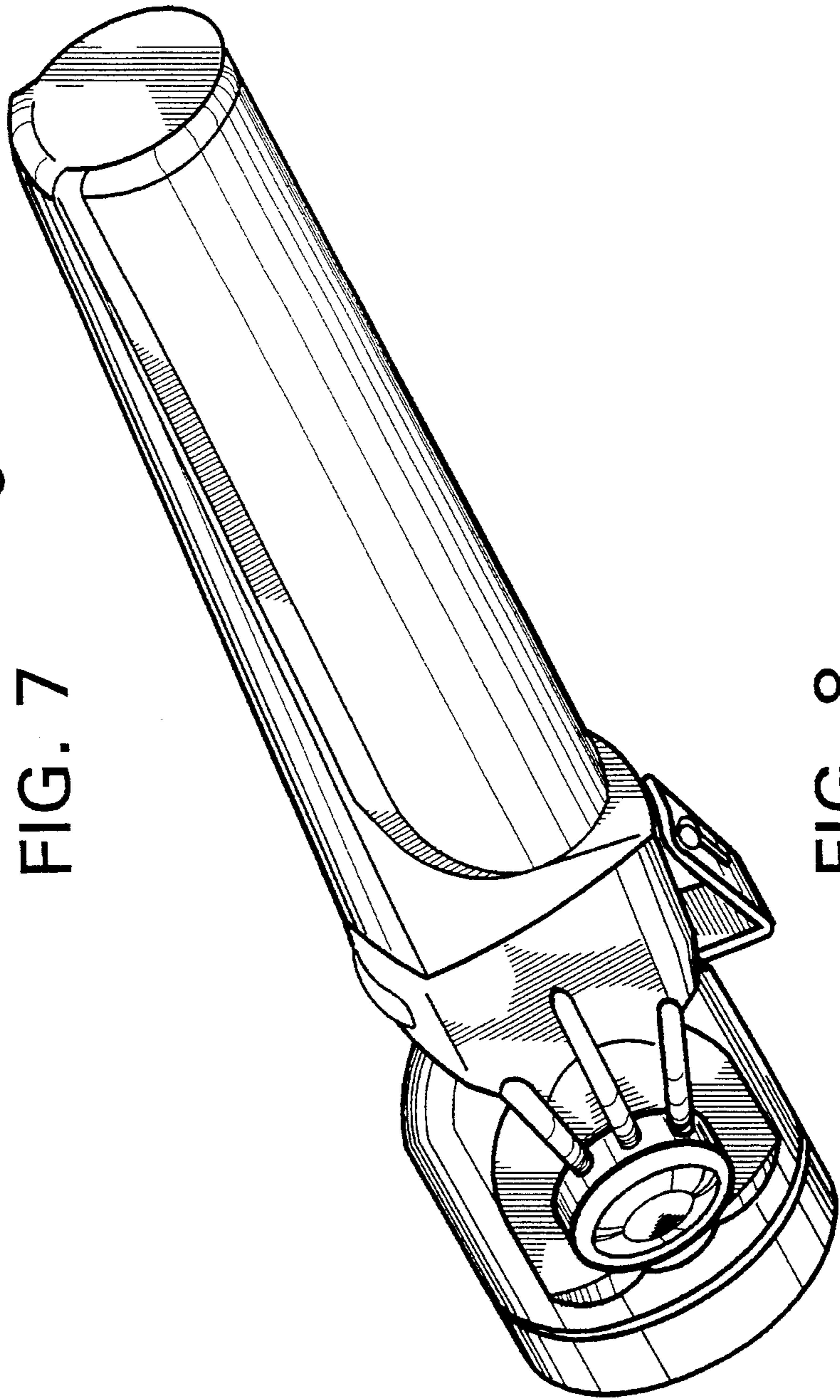

FIG. 8



