



US00D378393S

United States Patent [19]

[11] Patent Number: **Des. 378,393**

Marshall et al.

[45] Date of Patent: ****Mar. 11, 1997**

[54] **BILLIARD TABLE AIMING SYSTEM**

[57] **CLAIM**

[76] Inventors: **Bryan Marshall; William E. Marshall**,
both of R.R. 2, Box 239, Greentown,
Pa. 18426

The ornamental design for a billiard table aiming system, as shown and described.

[**] Term: **14 Years**

DESCRIPTION

[21] Appl. No.: **53,059**

FIG. 1 is an exploded perspective view of a billiard table aiming system showing our new design; consisting of a monitor, billiard table and a display screen;

[22] Filed: **Apr. 16, 1996**

FIG. 2 is a top view of a monitor thereof; shown separately for clarity;

[52] U.S. Cl. **D21/232**

FIG. 3 is a bottom view thereof;

[58] Field of Search D21/232; 473/1,
473/2, 4, 19, 23, 53; 273/31

FIG. 4 is a right side view thereof;

FIG. 5 is a left side view thereof;

[56] References Cited

U.S. PATENT DOCUMENTS

D. 160,374	10/1950	De Voy	D21/232
2,380,756	7/1945	Henry	473/4
3,463,593	8/1969	Horan	473/2
4,268,033	5/1981	Fontaine	473/2
4,344,622	8/1982	Nissim	273/31
5,178,389	1/1993	Bently et al.	273/31
5,199,704	4/1993	Badami	473/2
5,275,398	1/1994	Compton	473/2
5,338,262	8/1994	Hayes	473/2
5,401,215	3/1995	Pfost	473/2

FIG. 6 is a front view thereof;

FIG. 7 is a rear view thereof;

FIG. 8 is top view of a billiard table thereof; shown separately for clarity;

FIG. 9 bottom view thereof;

FIG. 10 is a left side view thereof; the right side view is a mirror image thereof;

FIG. 11 is a front view thereof; the rear view is a mirror image thereof;

FIG. 12 is a front view of a display screen thereof; shown separately for clarity;

FIG. 13 is a rear view thereof;

FIG. 14 is a left side view thereof; the right side view is a mirror image thereof;

FIG. 15 is a top view thereof; and,

FIG. 16 is a bottom view thereof.

FOREIGN PATENT DOCUMENTS

2228205	8/1990	United Kingdom	473/2
2238481	5/1991	United Kingdom	473/2

Primary Examiner—Prabhakar G. Deshmukh
Attorney, Agent, or Firm—Harold H. Dutton, Jr.; W. Charles L. Jamison; Diane F. Liebman

1 Claim, 9 Drawing Sheets

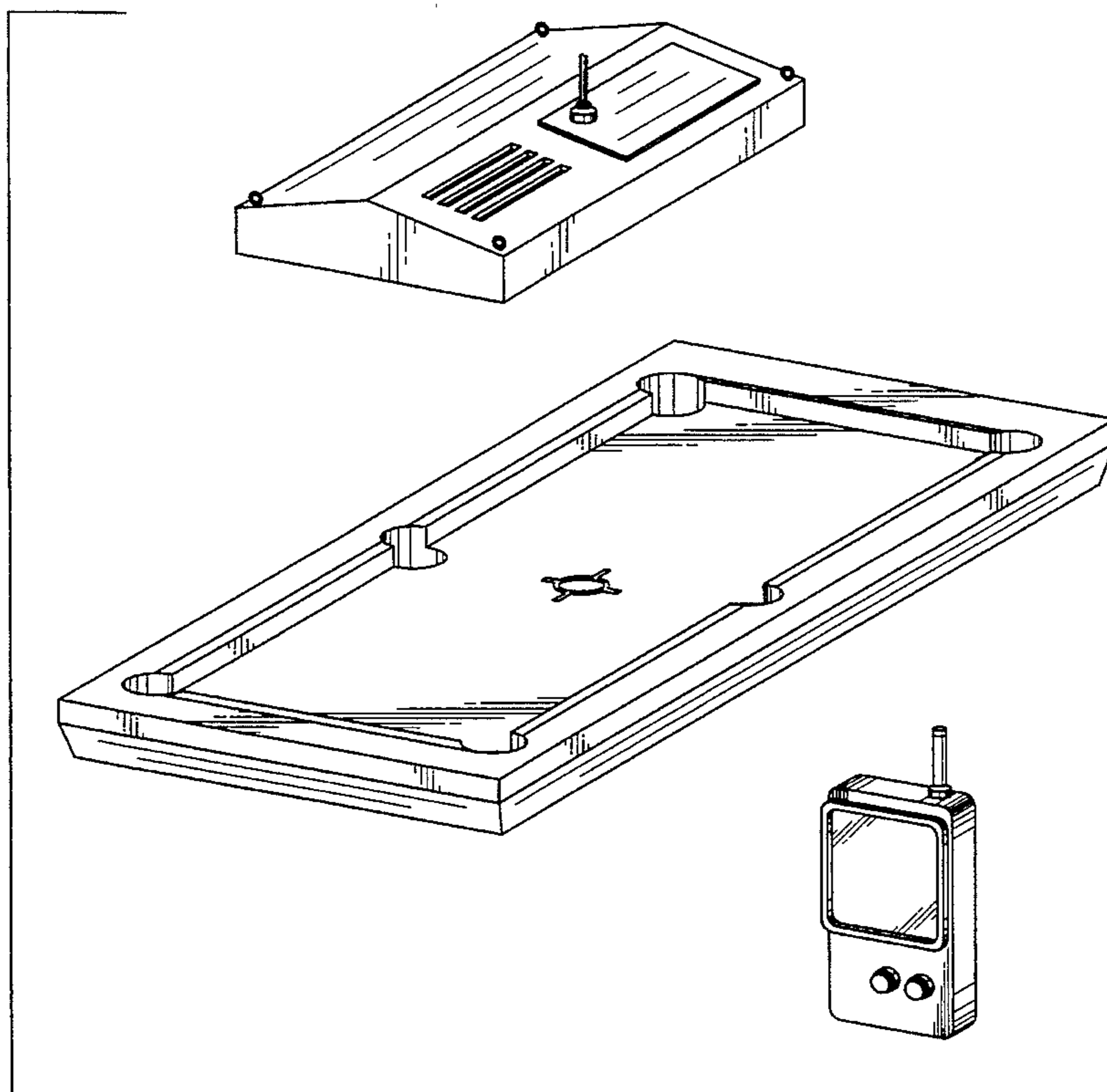

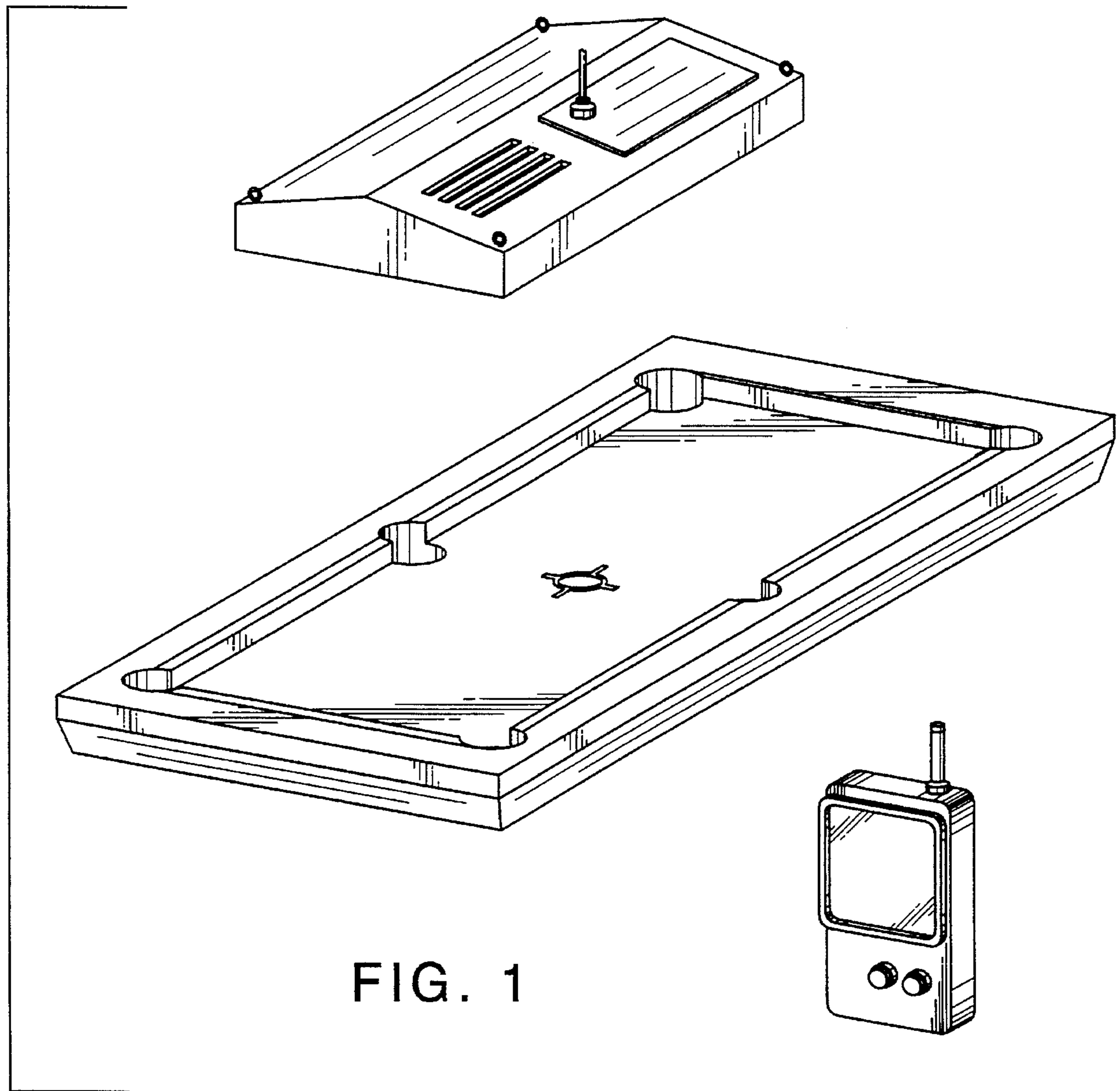

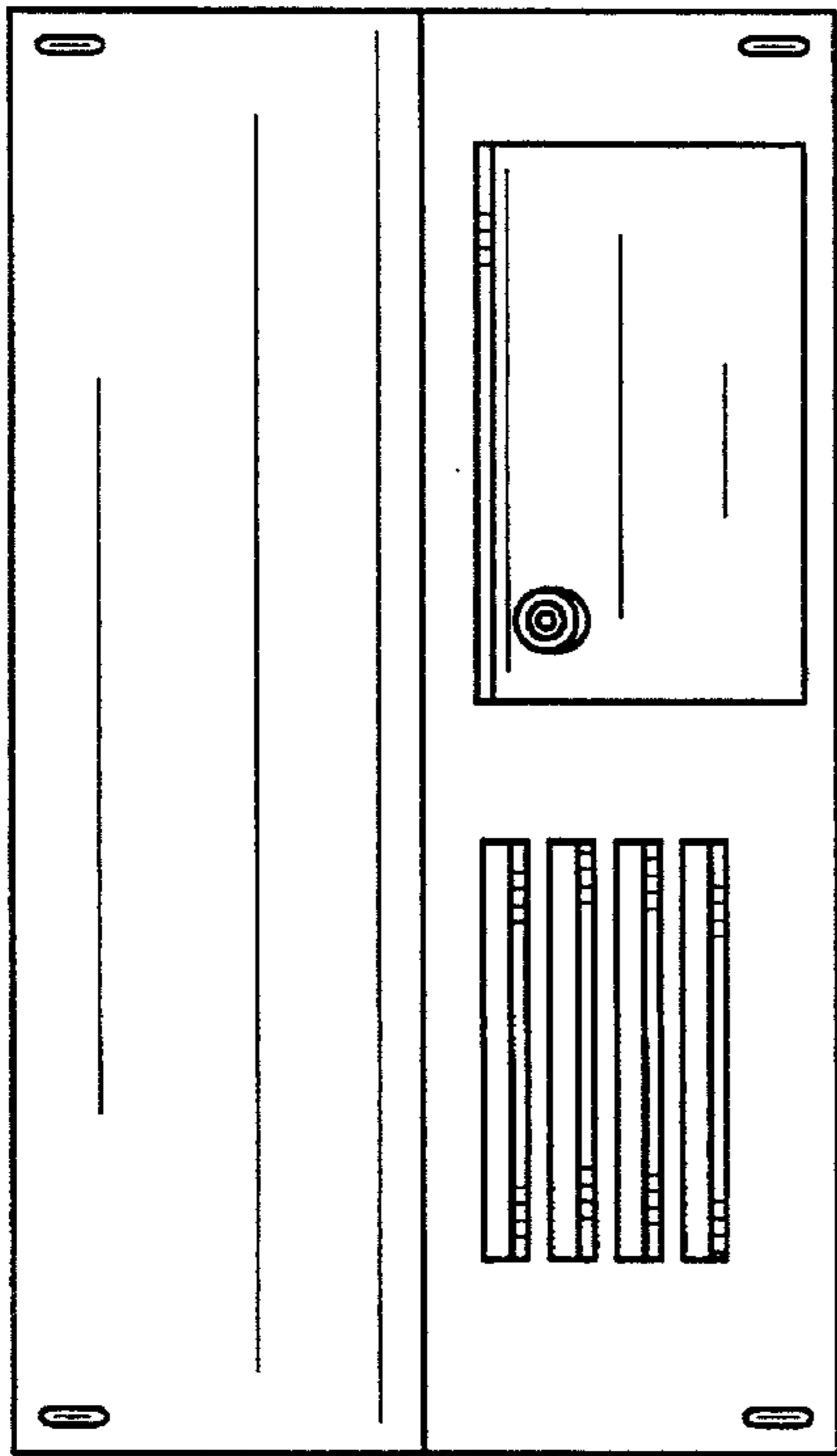
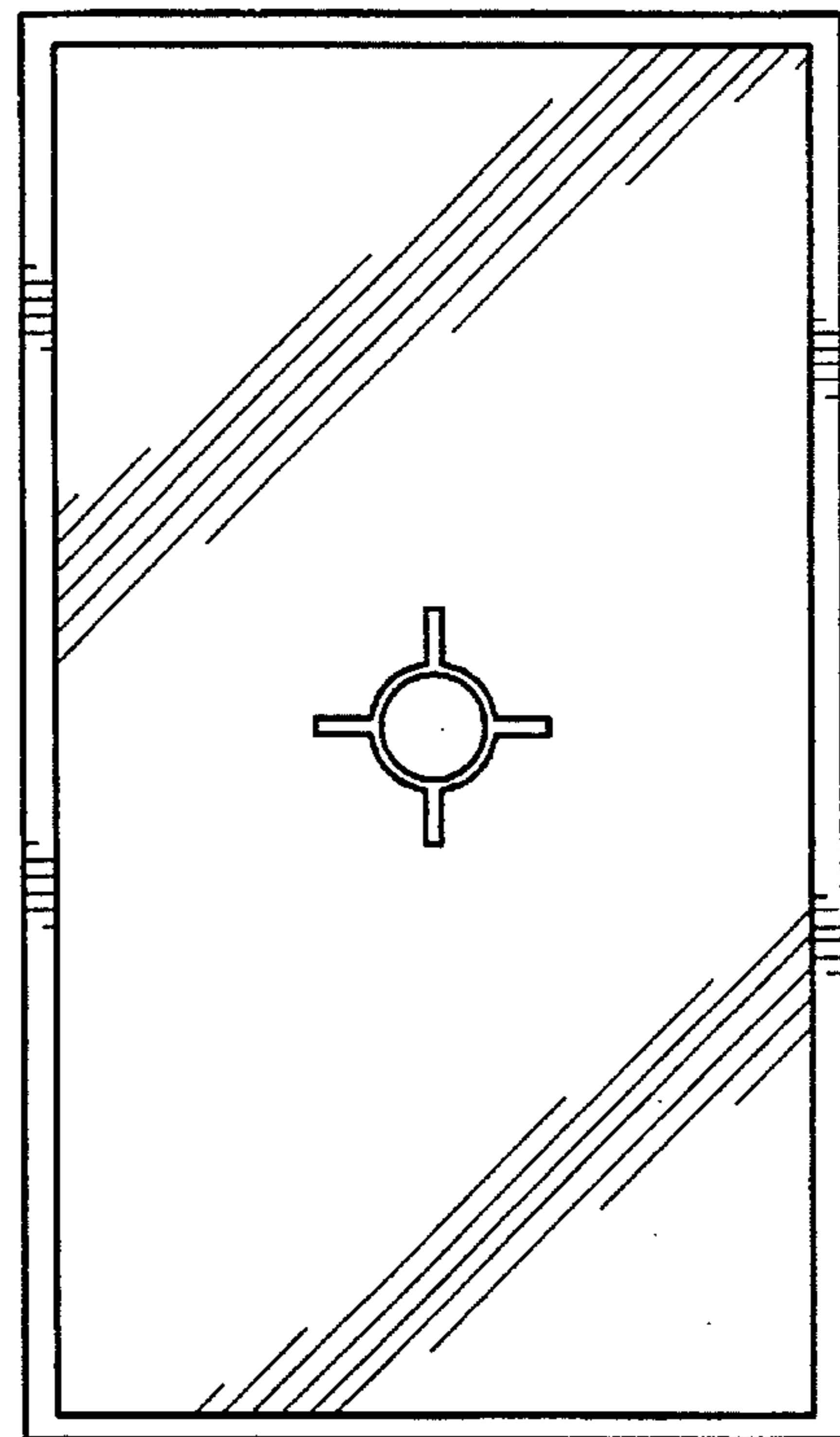

FIG. 2

FIG. 3



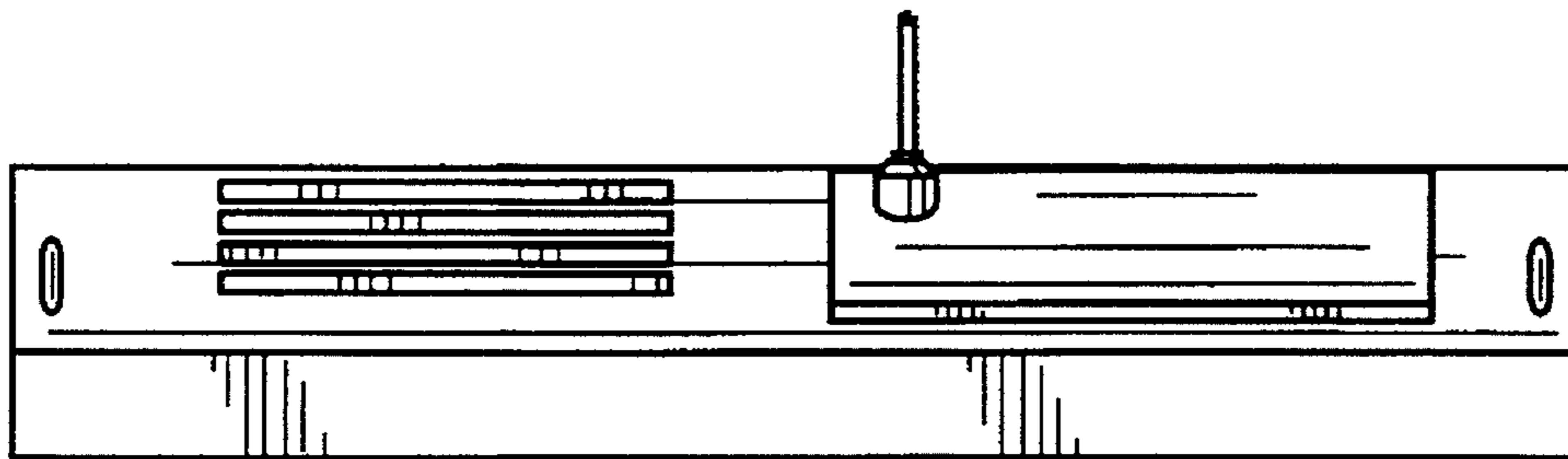

FIG. 4

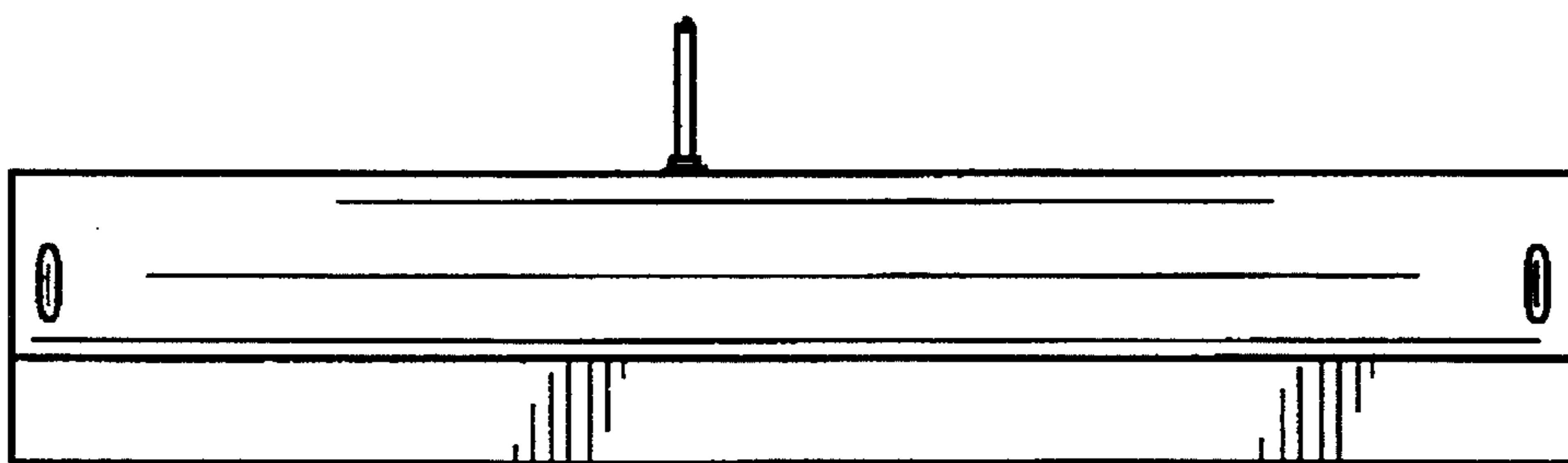

FIG. 5

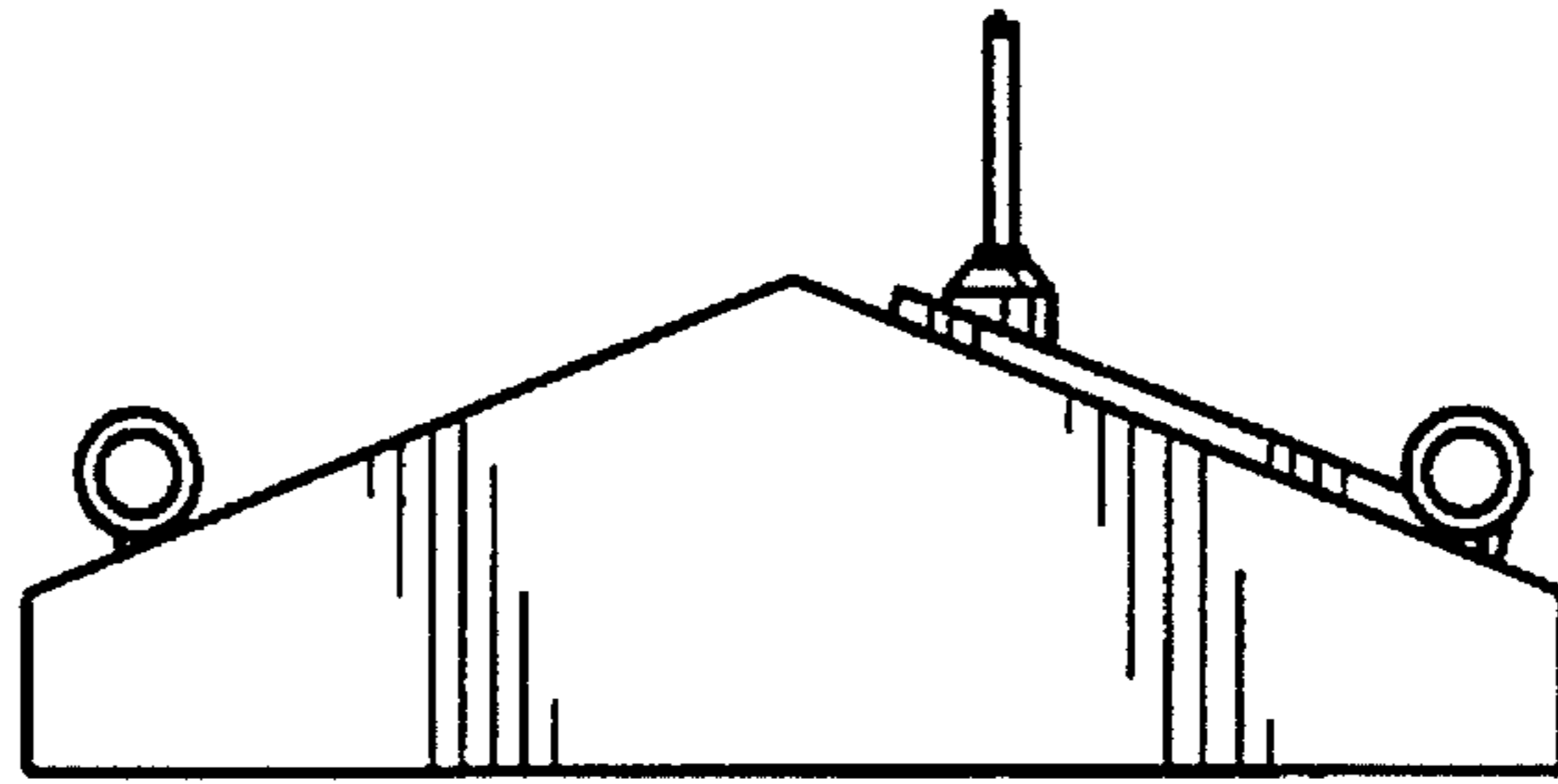

FIG. 6

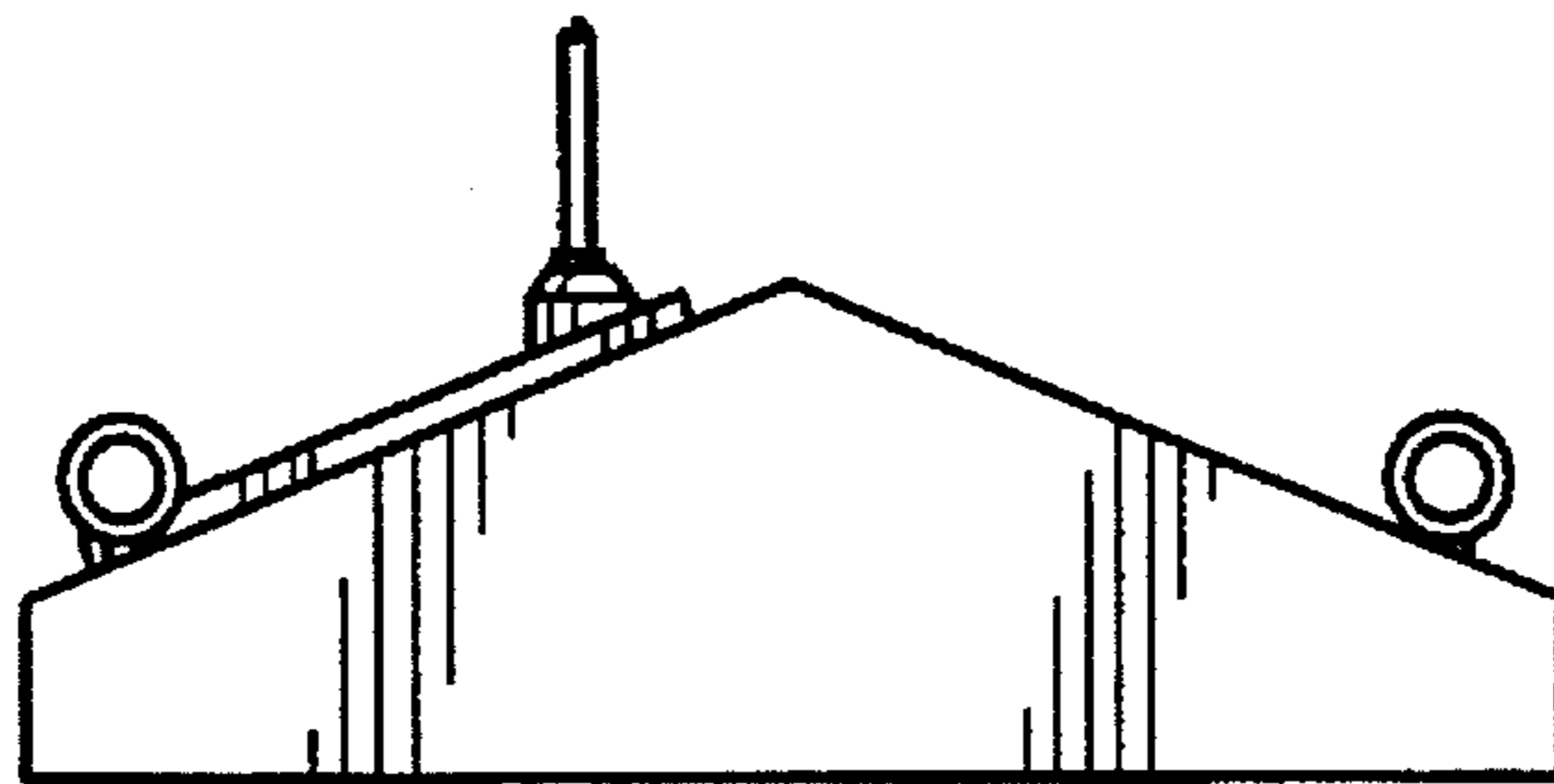

FIG. 7

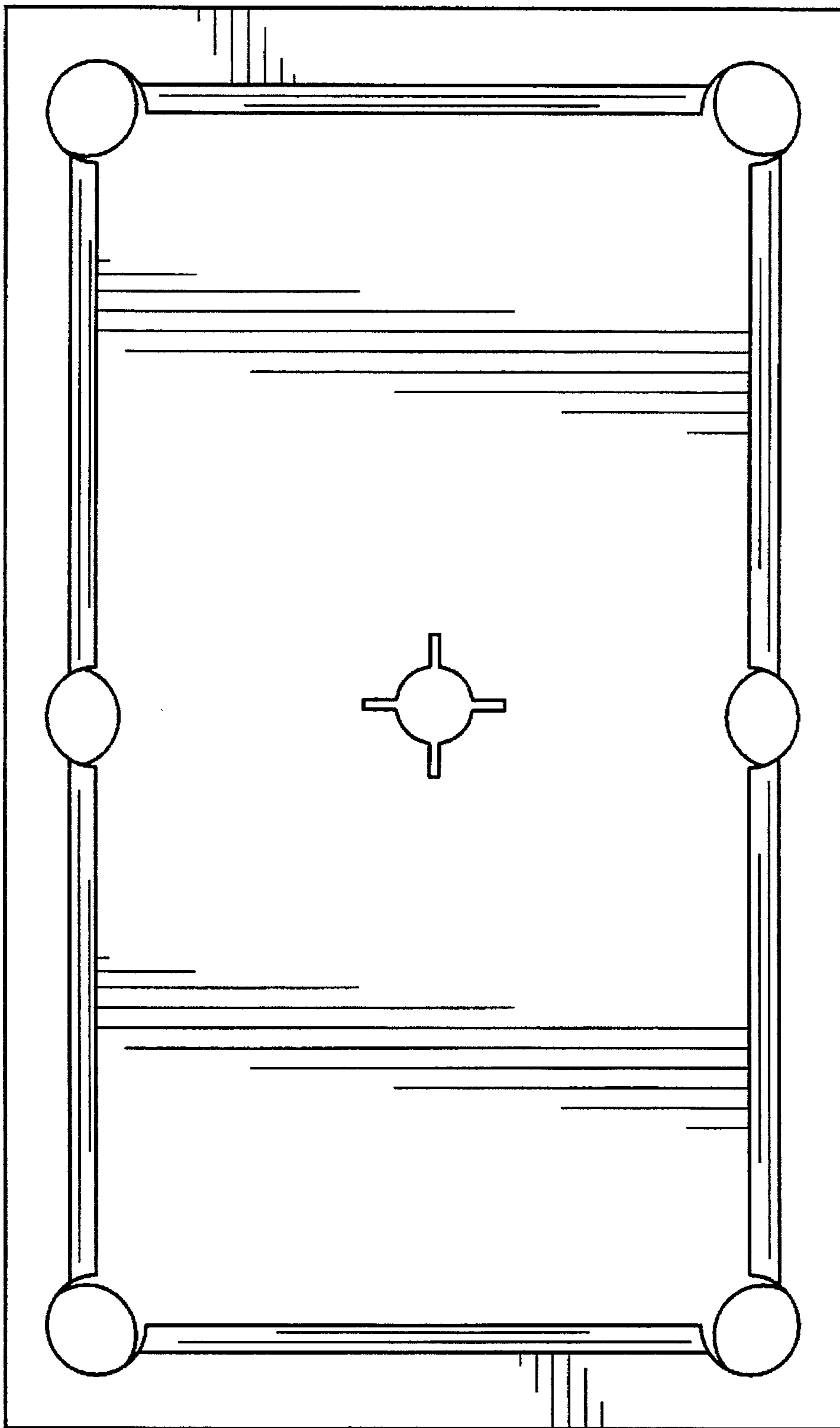

FIG. 8

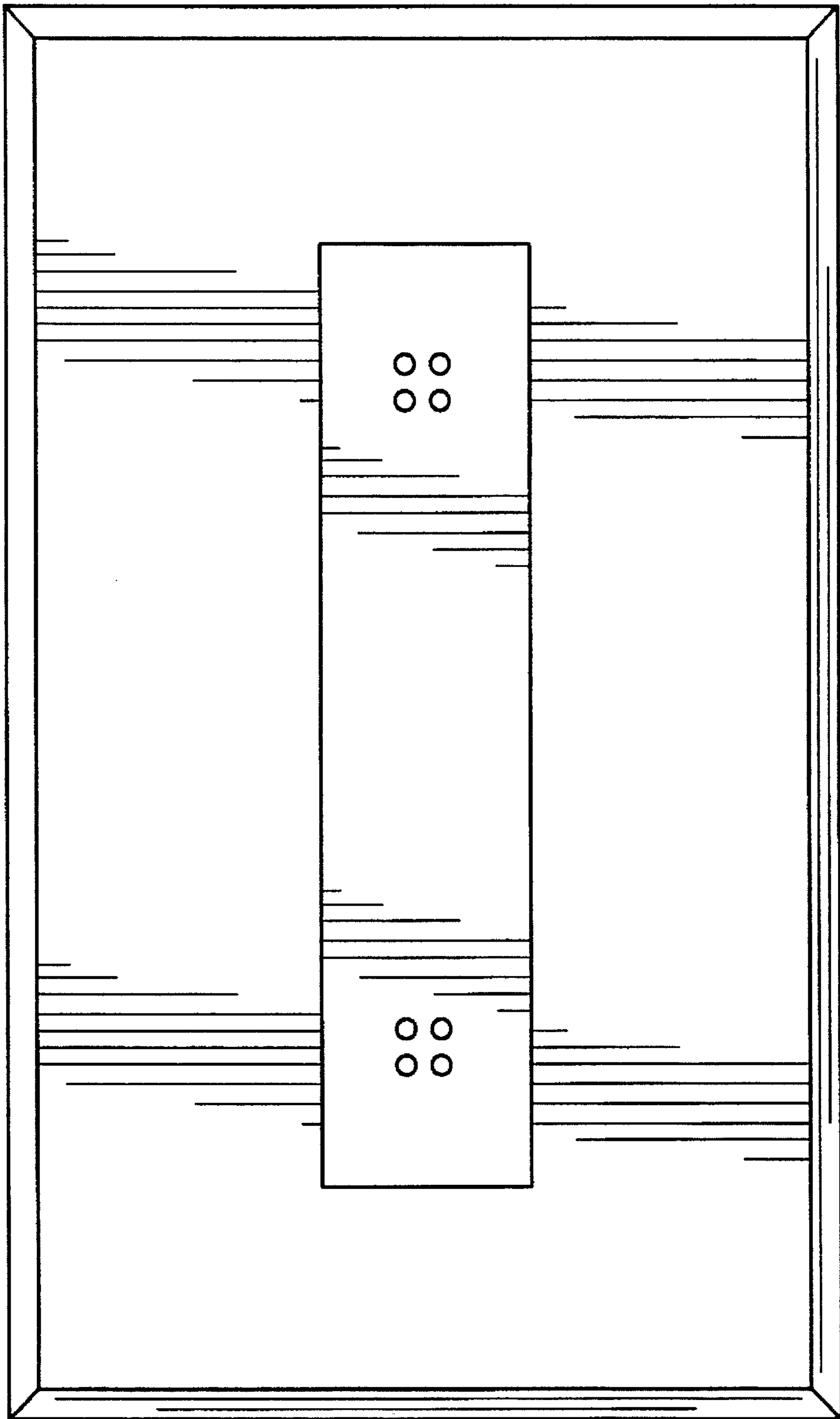

FIG. 9

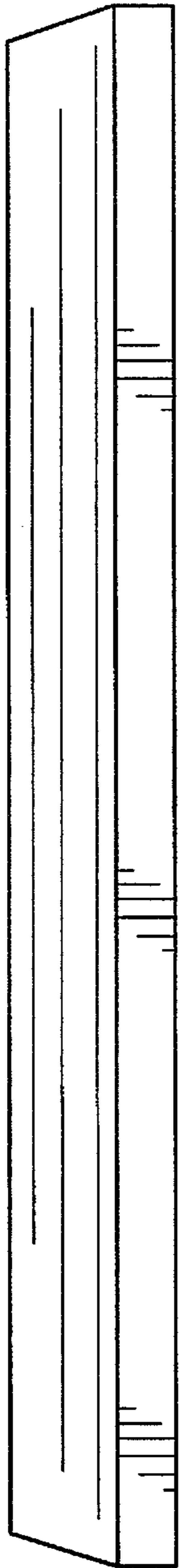

FIG. 10

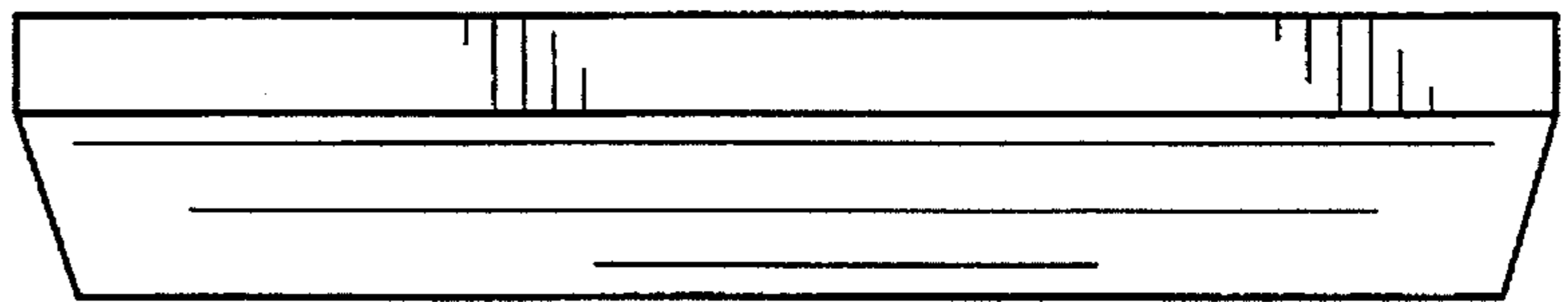

FIG. 11

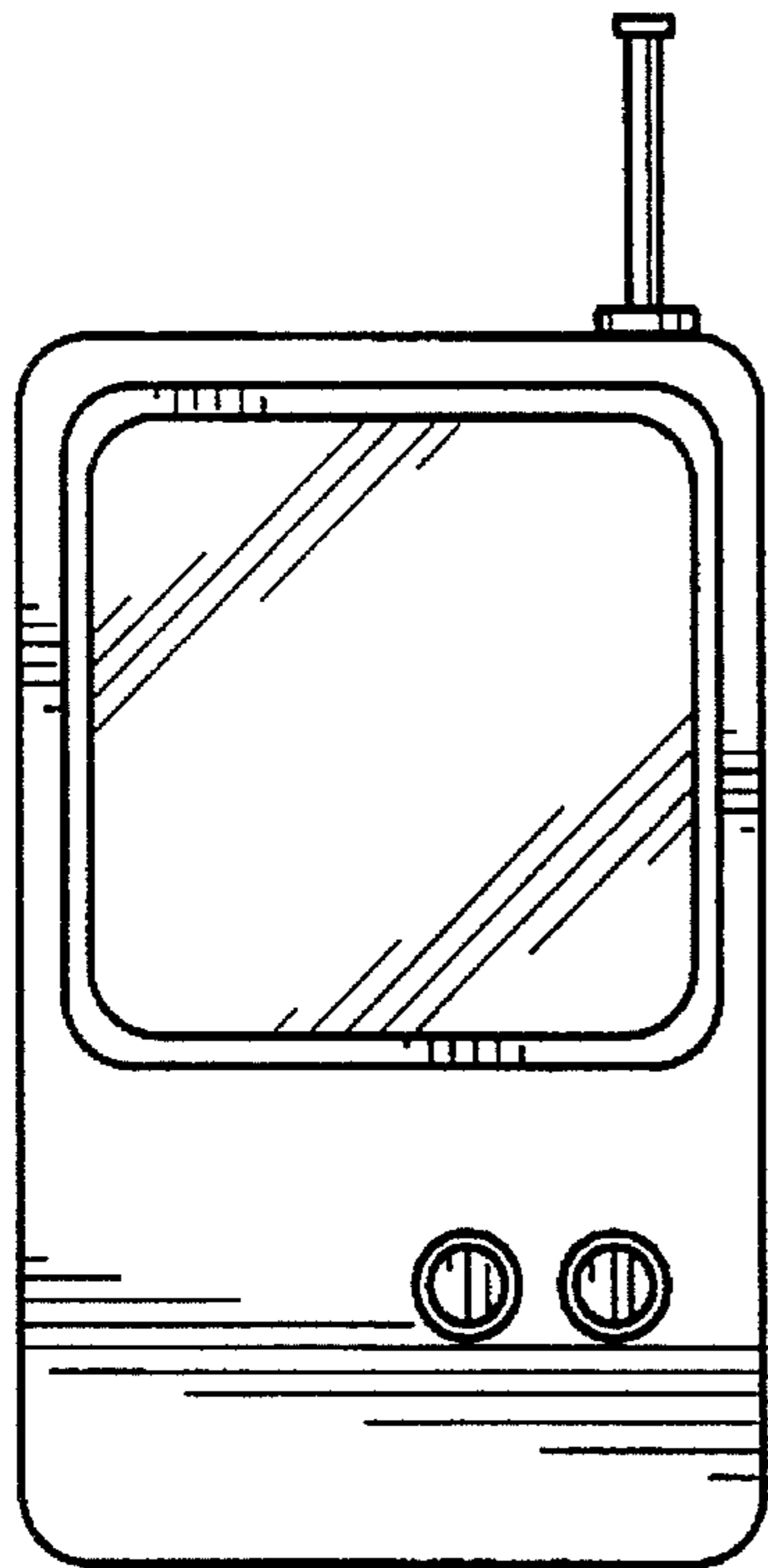

FIG. 12

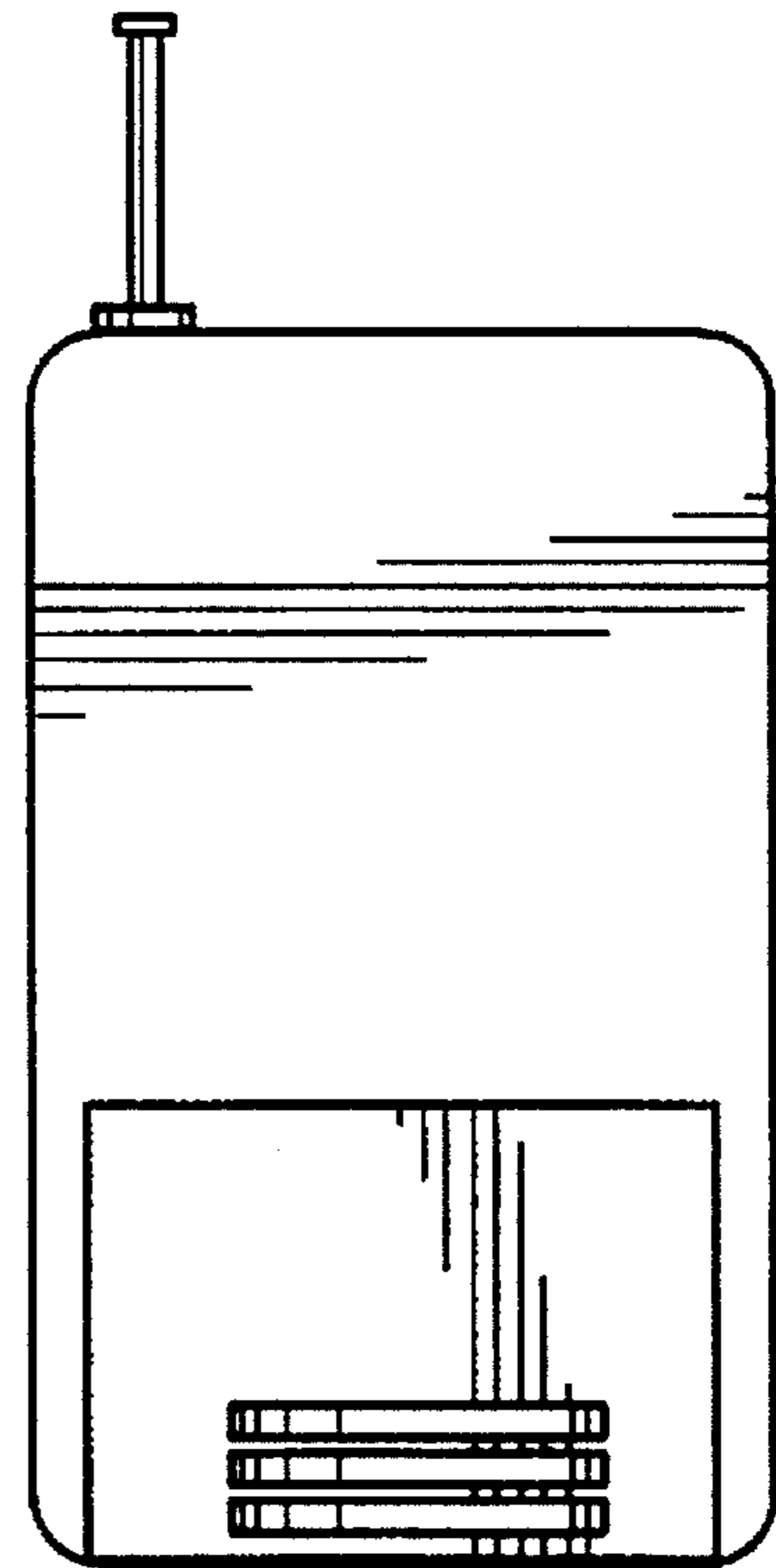

FIG. 13

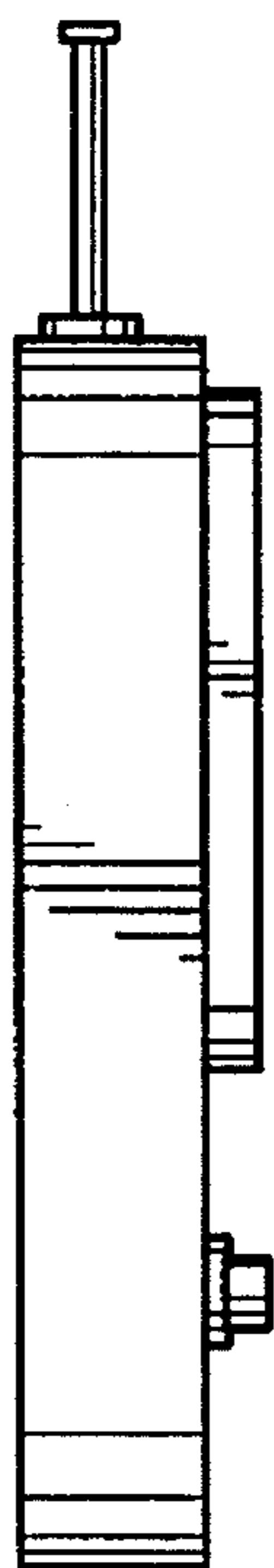

FIG. 14

FIG. 15

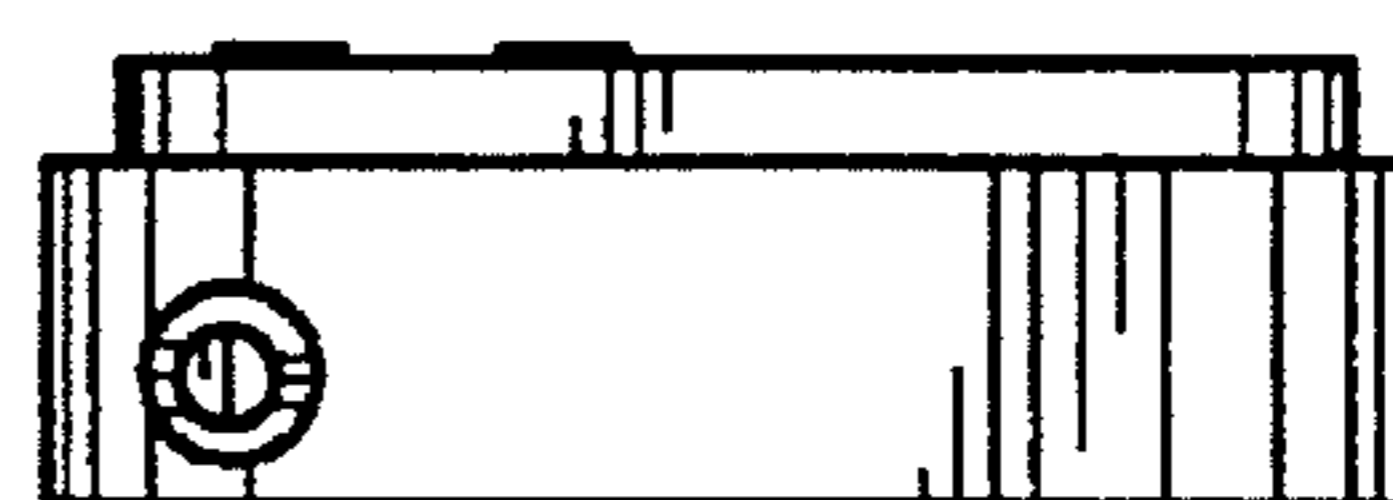

FIG. 16

