



US00D378383S

**United States Patent** [19]

[11] **Patent Number: Des. 378,383**

**Jarrell**

[45] **Date of Patent: \*\*Mar. 11, 1997**

[54] **LOTTERY NUMBER SELECTOR**

5,370,393 12/1994 Taylor et al. .

[76] Inventor: **Merwin Jarrell**, 1012 Schiefers Branch Rd., Herman, Mo. 65041

**FOREIGN PATENT DOCUMENTS**

[\*\*] Term: **14 Years**

2397025 3/1979 France ..... 273/142 HA  
3531375 3/1987 France ..... 273/142 HA

[21] Appl. No.: **49,932**

*Primary Examiner*—Terry A. Wallace  
*Assistant Examiner*—Mitchell I. Siegel  
*Attorney, Agent, or Firm*—Polster, Lieder, Woodruff & Lucchesi

[22] Filed: **Feb. 5, 1996**

[52] **U.S. Cl.** ..... **D21/39**

[58] **Field of Search** ..... D21/37-41; 273/148 R, 273/142 HA, 141 R, 269, 274

[57] **CLAIM**

The ornamental design for lottery number selector, as shown and described.

[56] **References Cited**

**DESCRIPTION**

**U.S. PATENT DOCUMENTS**

D. 111,527	9/1938	Troth .....	D21/40 X
D. 330,733	11/1992	Strey et al. ....	D21/39 X
D. 345,385	3/1994	Palatin .	
D. 360,902	8/1995	Lee et al. .	
2,065,424	12/1936	Brubaker .....	273/142 HA
4,721,309	1/1988	Miesel .	
4,886,271	12/1989	Brown .	
5,123,648	6/1992	Schmidt .	
5,232,222	8/1993	Deutch .	

FIG. 1 is a perspective view of my lottery number selector; FIG. 2 is a front elevational view thereof; FIG. 3 is a rear elevational view thereof; FIG. 4 is a side elevational view thereof; the right and left side views being mirror images of each other; FIG. 5 is a top plan view thereof; and, FIG. 6 is a bottom plan view thereof.

**1 Claim, 2 Drawing Sheets**

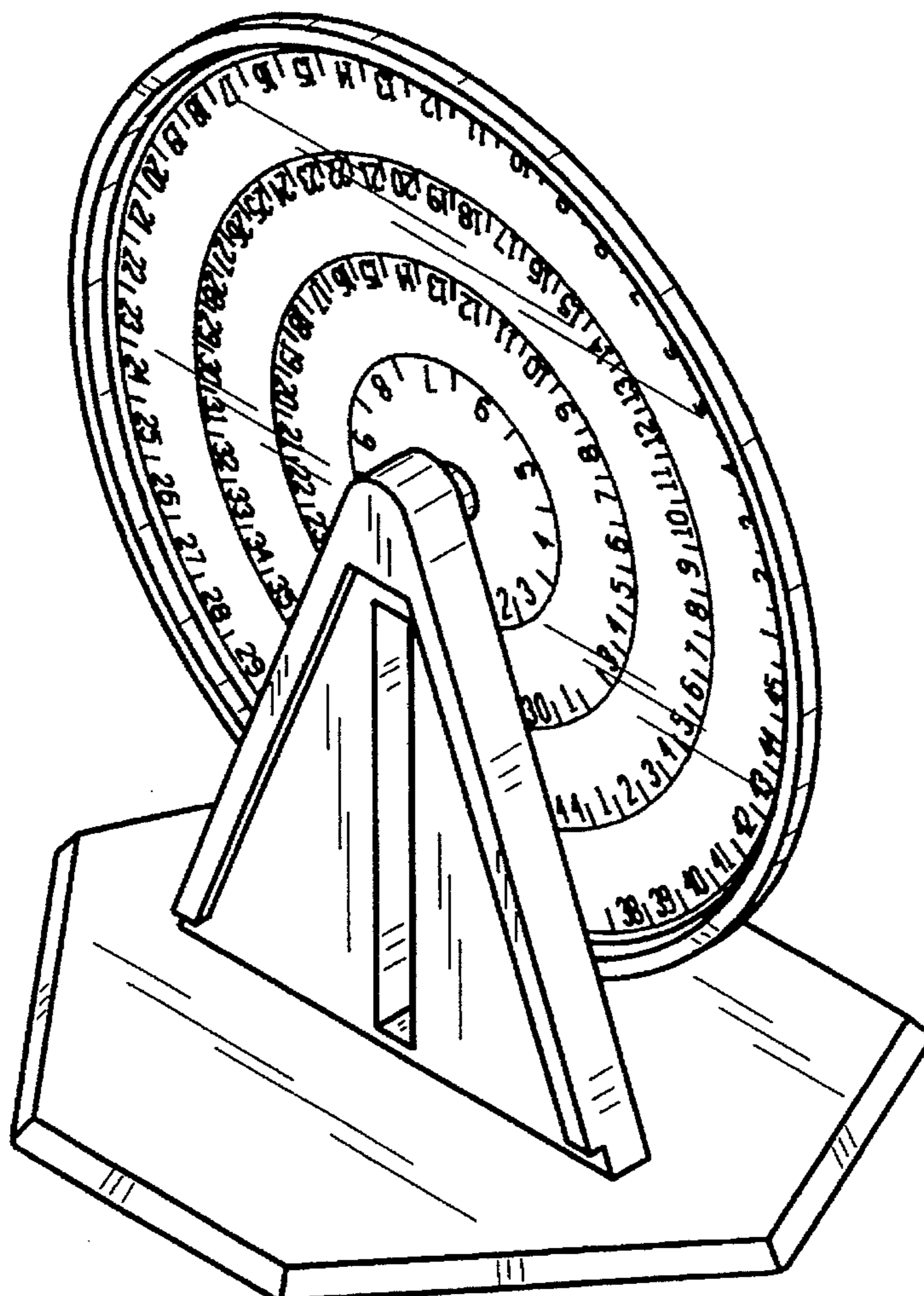

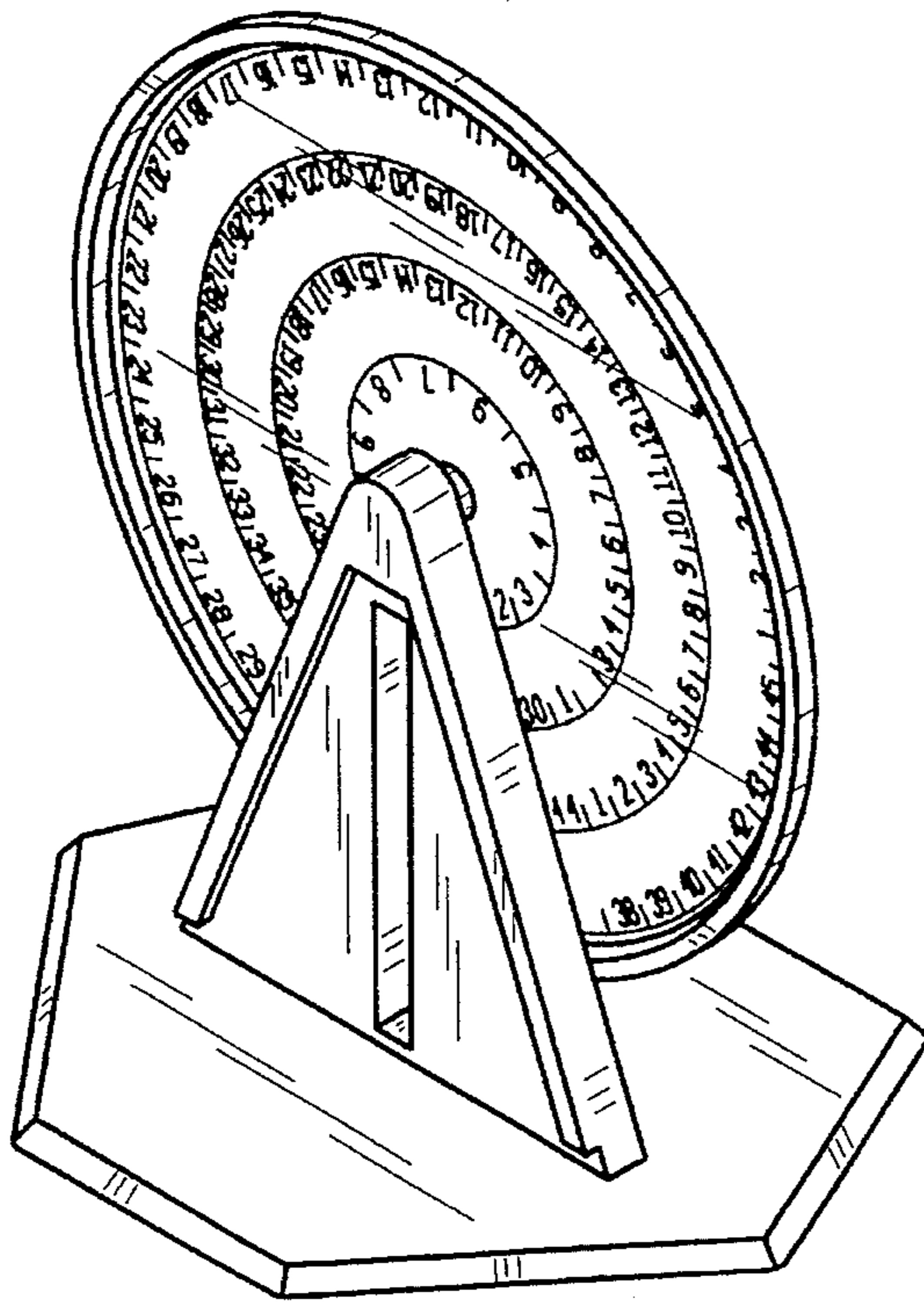

FIG. 1

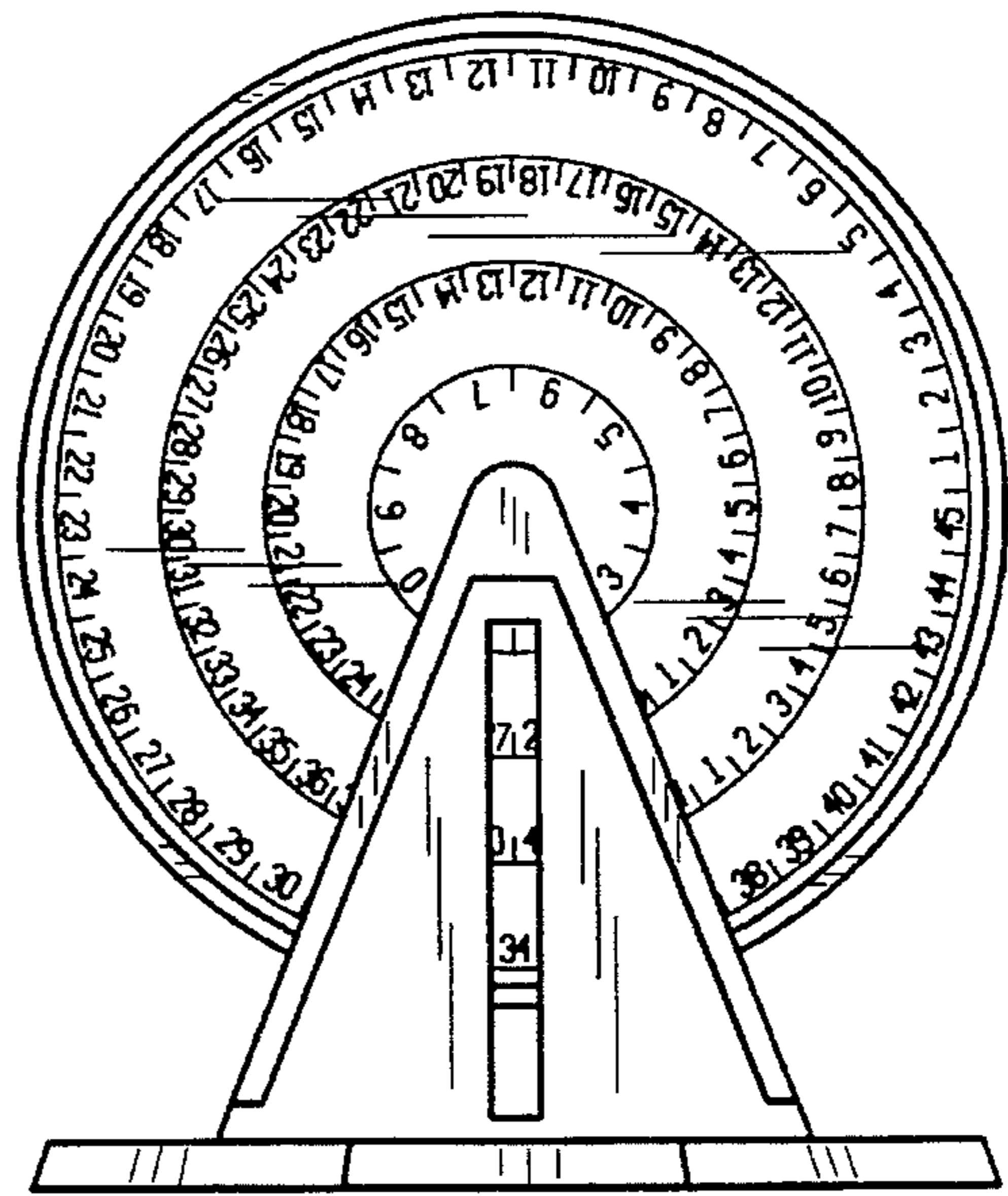

FIG. 2

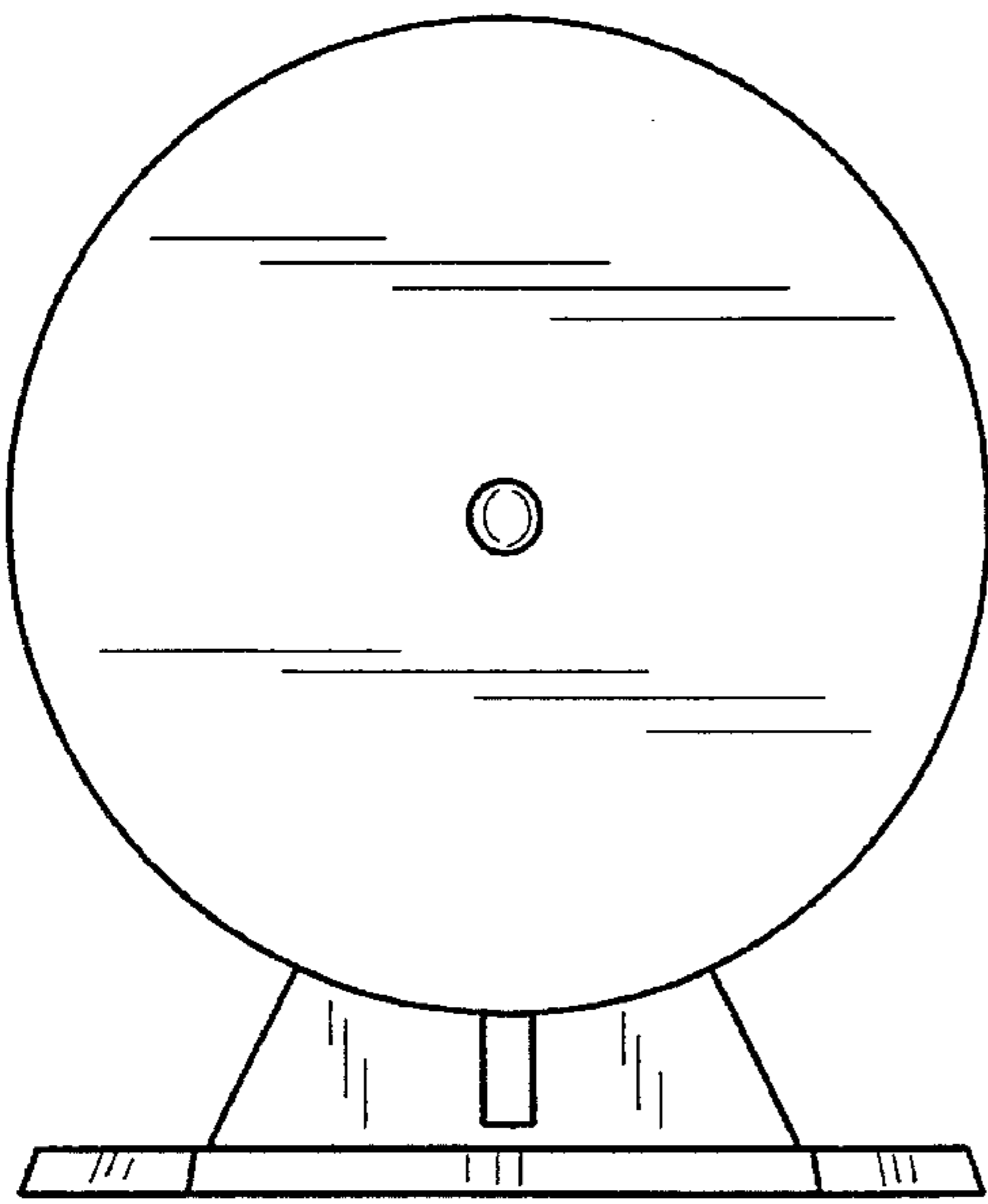

FIG. 3

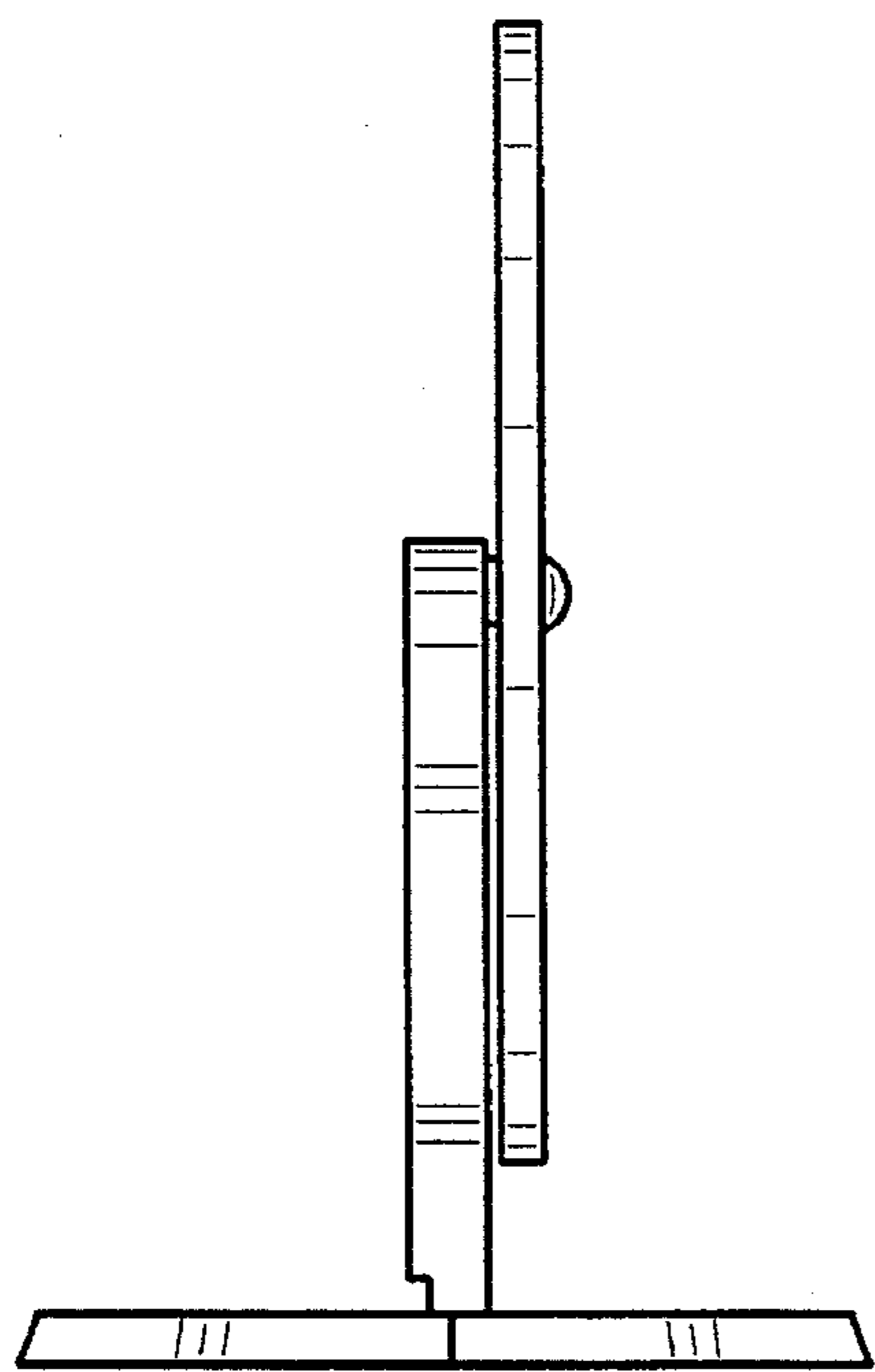

FIG. 4

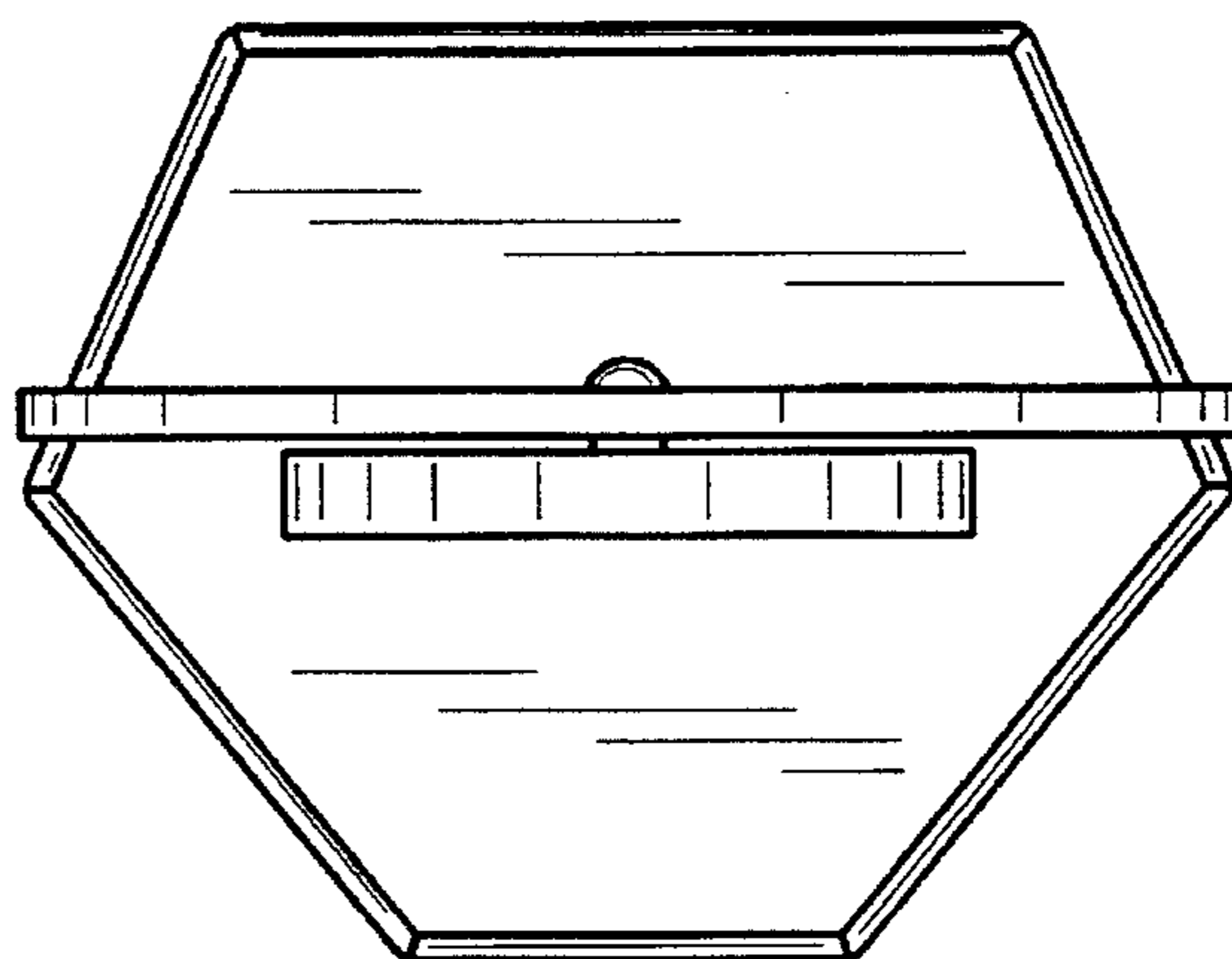

FIG. 5

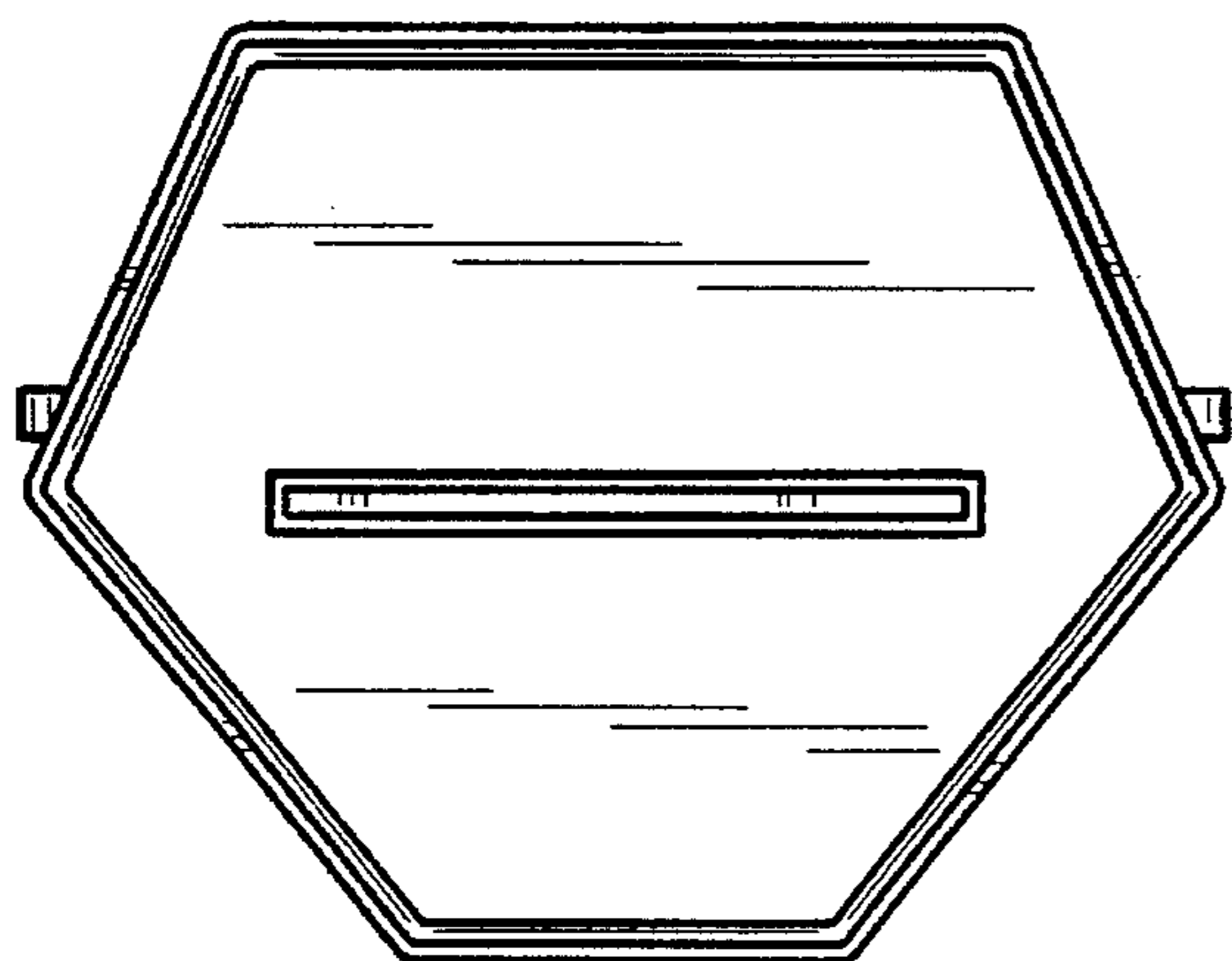

FIG. 6