



US00D378368S

# United States Patent [19]

[11] Patent Number: **Des. 378,368**

McGreevy

[45] Date of Patent: **\*\*Mar. 11, 1997**

[54] **LOW POWER TRANSMITTER AND RECEIVER**

D. 345,982	4/1994	Lucey .....	D14/230
D. 346,598	5/1994	McCay et al. ....	D14/137
D. 347,010	5/1994	Emmerling .....	D14/230

[75] Inventor: **William T. McGreevy**, Babylon, N.Y.

*Primary Examiner*—B. J. Bullock  
*Assistant Examiner*—Richelle Shelton  
*Attorney, Agent, or Firm*—Curtis, Morris & Safford

[73] Assignee: **Recoton Corporation**, Long Island City, N.Y.

[\*\*] Term: **14 Years**

[57] **CLAIM**

[21] Appl. No.: **23,183**

The ornamental design for a low power transmitter and receiver, as shown and described.

[22] Filed: **May 19, 1994**

**DESCRIPTION**

**Related U.S. Application Data**

FIG. 1 is a front perspective view of a low power transmitter and receiver showing my new design;

[63] Continuation-in-part of Ser. No. 1,641, Nov. 18, 1992, Pat. No. Des. 347,219.

FIG. 2 is a top plan view thereof;

[52] U.S. Cl. .... **D14/137**; D14/230

FIG. 3 is a front elevational view thereof;

[58] **Field of Search** ..... D14/124, 137, D14/138, 155, 159, 188, 192-198, 230, 257, 299; 455/73, 89, 90, 100, 128, 347

FIG. 4 is a right side elevational view thereof;

FIG. 5 is a left side elevational view thereof;

FIG. 6 is a bottom plan view thereof; and,

FIG. 7 is a rear elevational view thereof.

[56] **References Cited**

The broken line showing of a cord in FIGS. 2, 4 and 5 is for illustrative purposes only and forms no part of the claimed design.

**U.S. PATENT DOCUMENTS**

D. 310,671	9/1990	Weiss .....	D14/230
D. 321,883	11/1991	Borchardt .....	D14/230

**1 Claim, 4 Drawing Sheets**

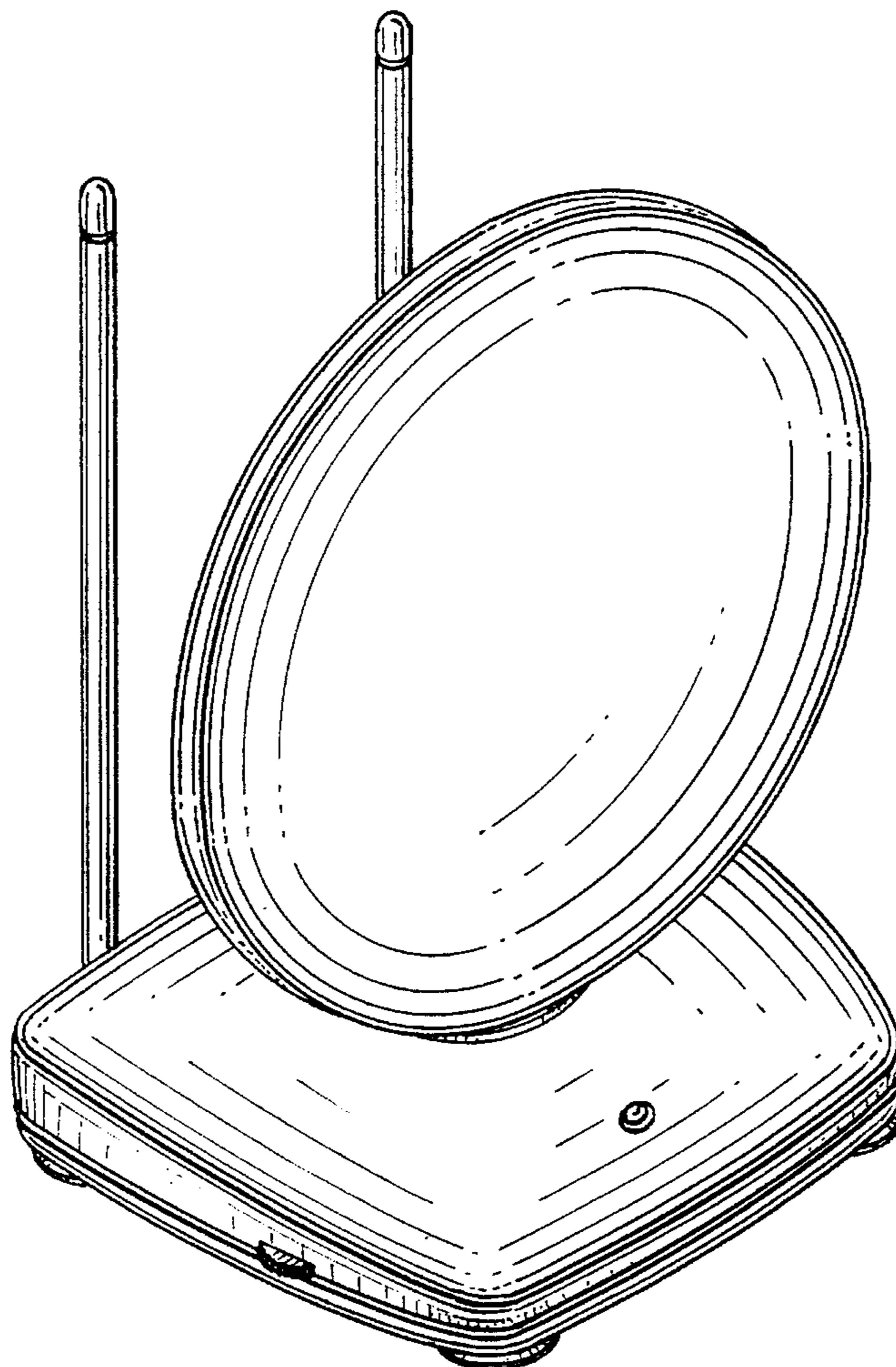

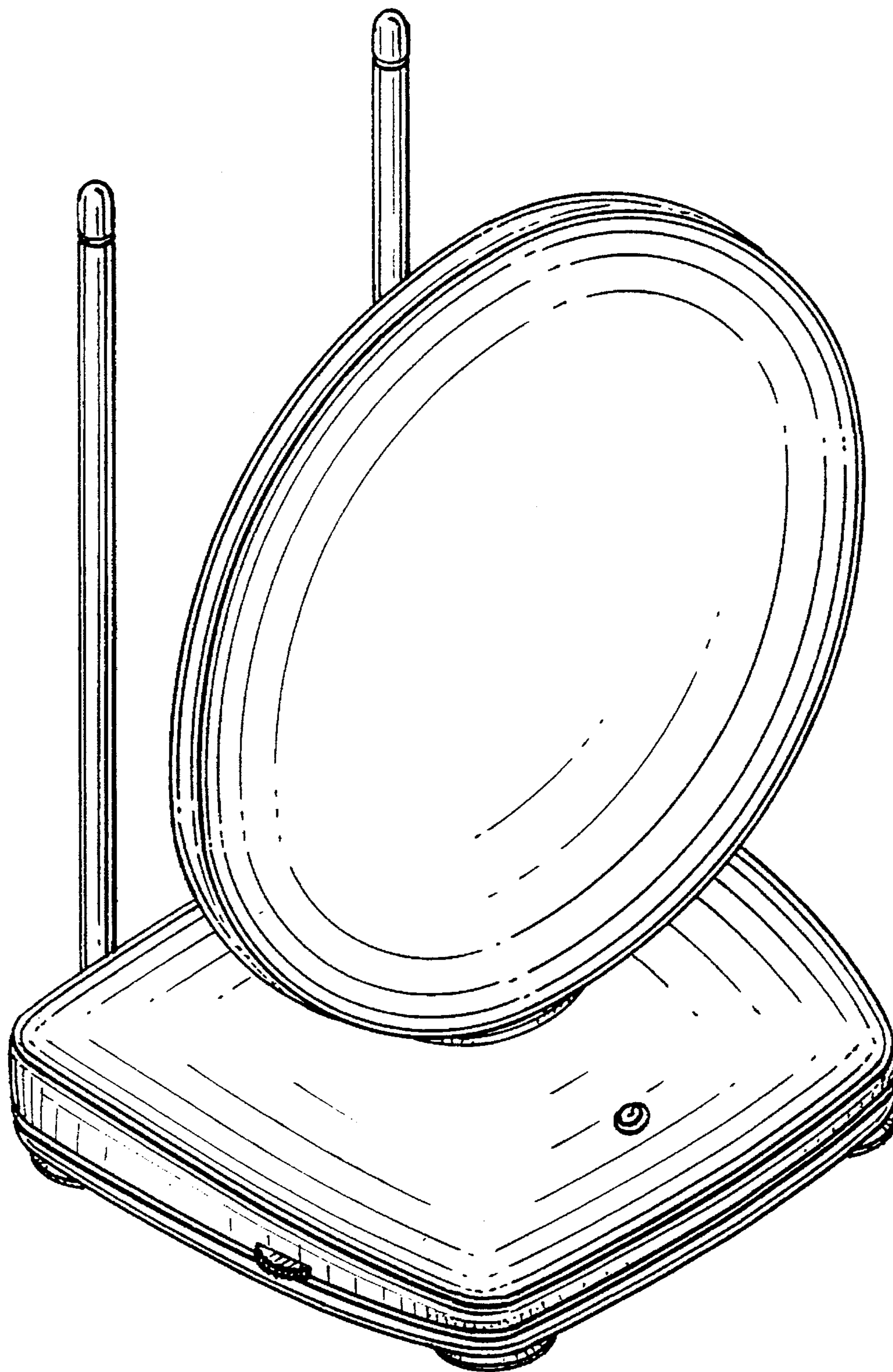

*FIG. 1*

FIG. 2

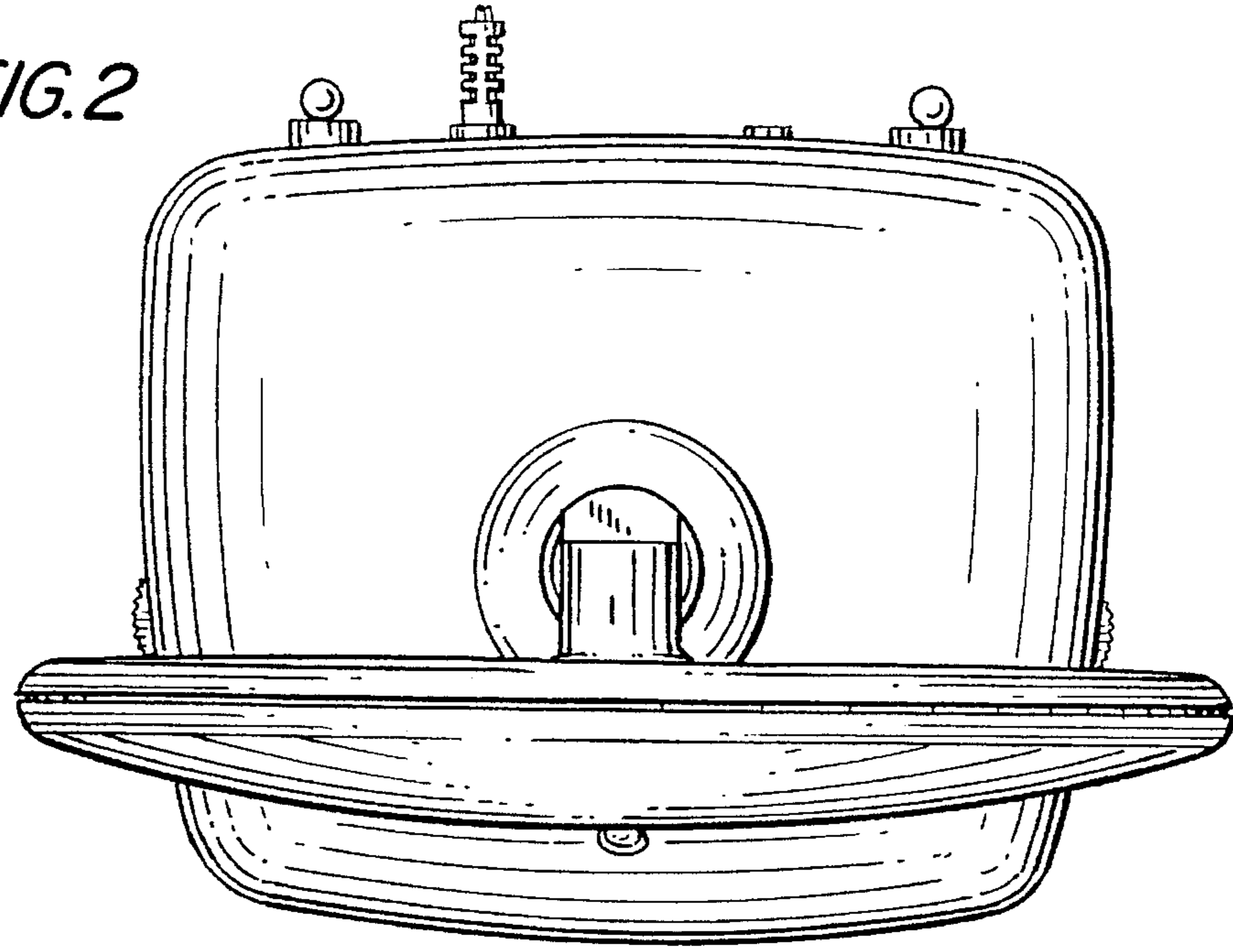
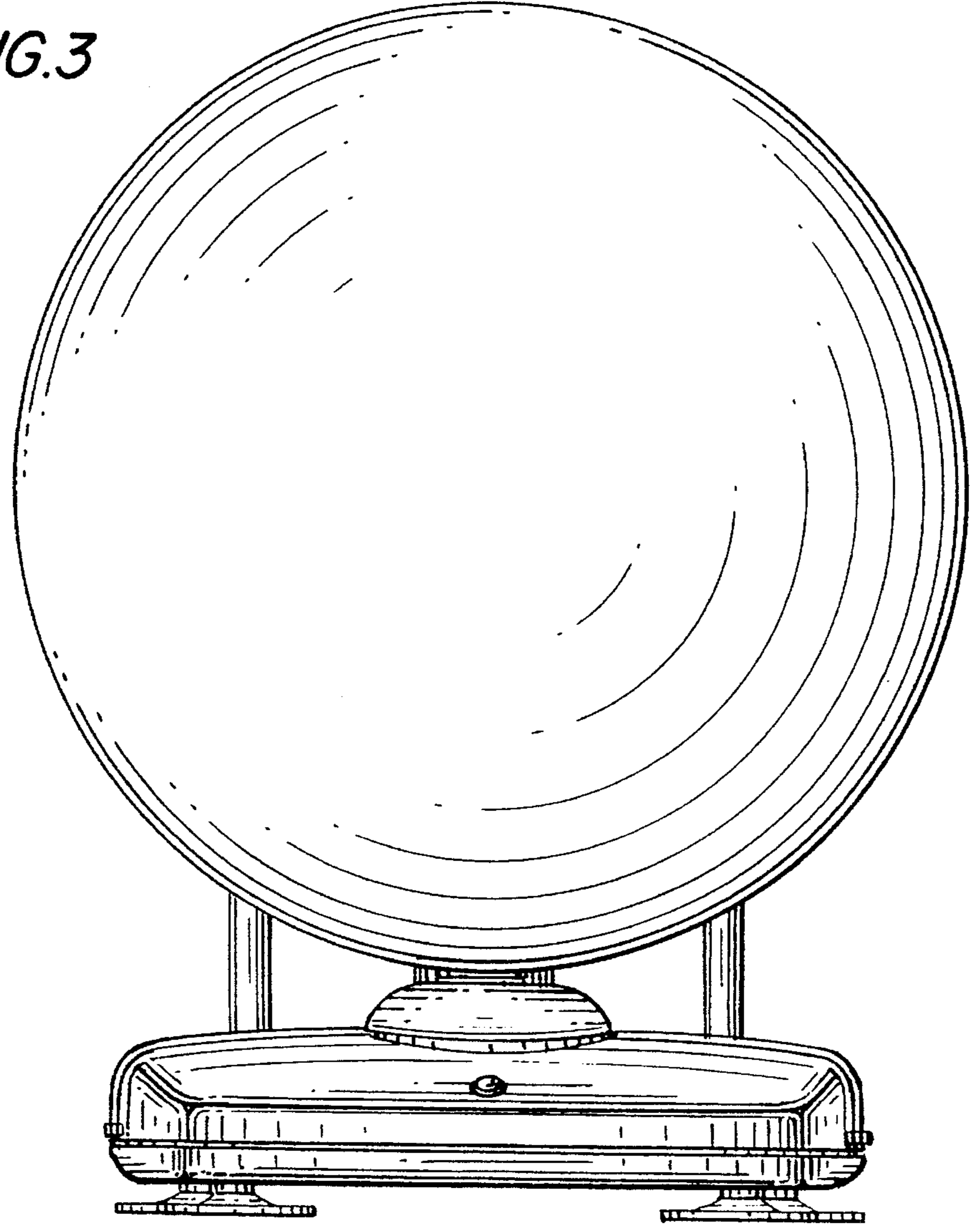

FIG. 3



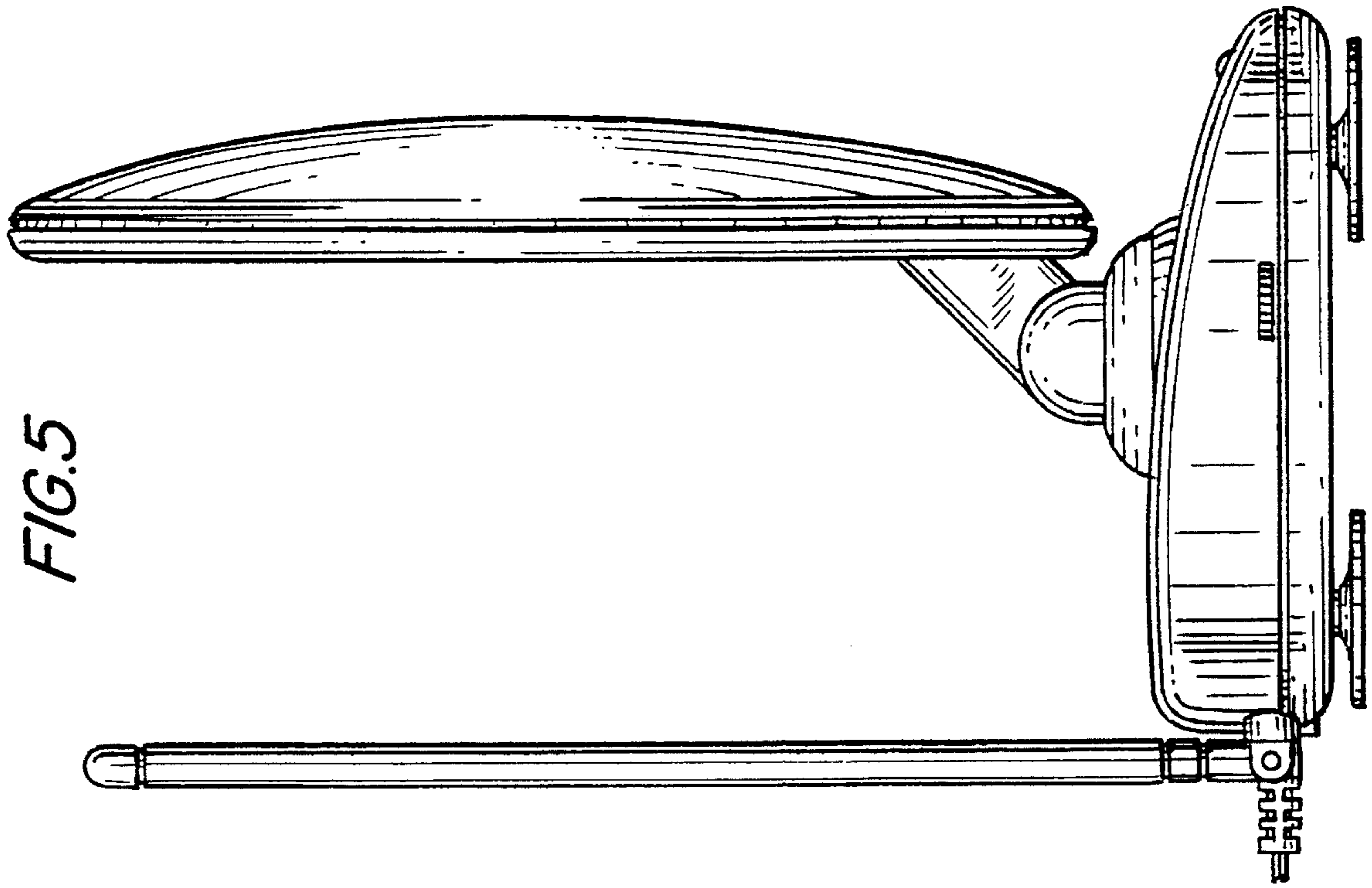

FIG. 5

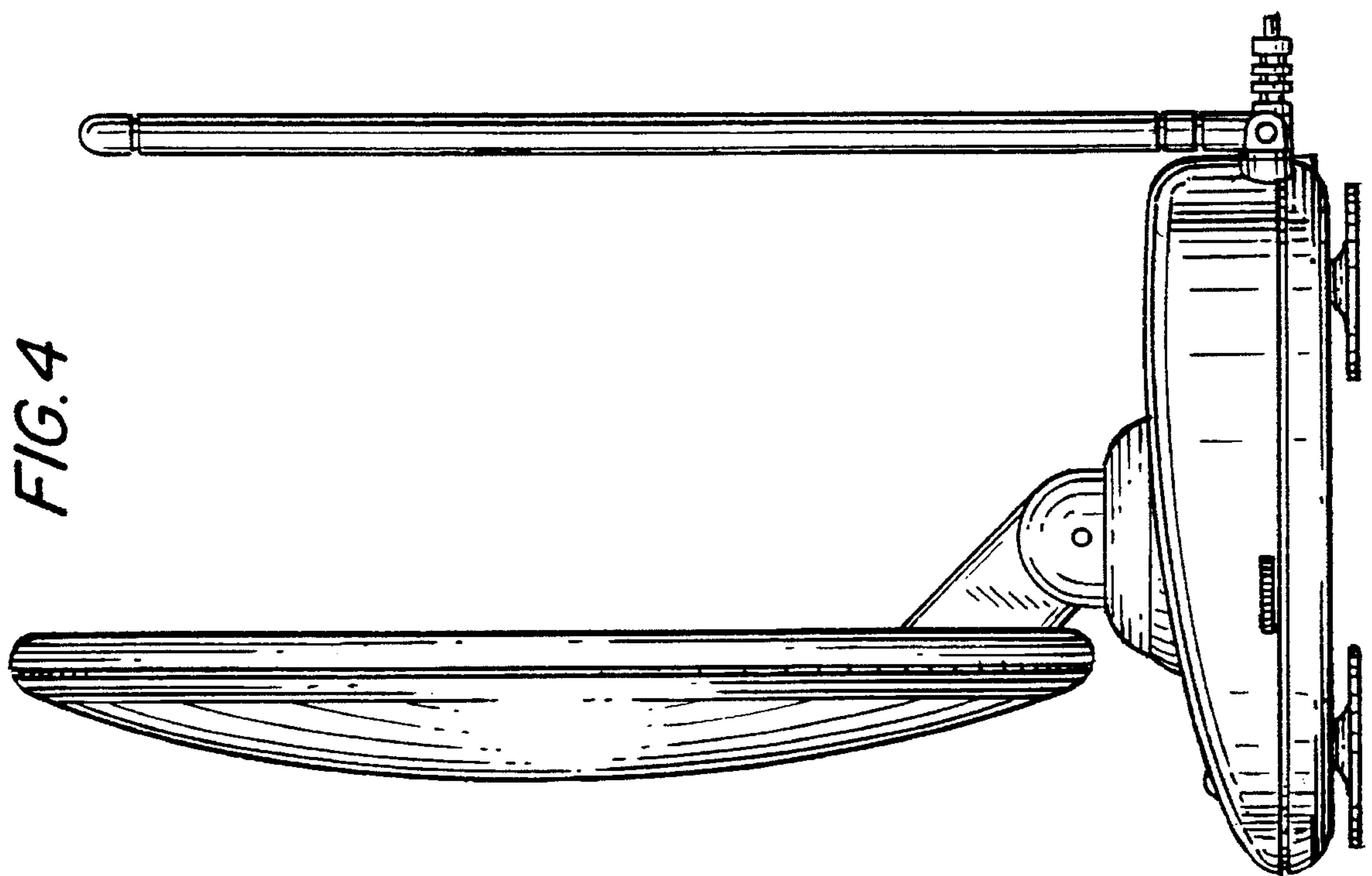

FIG. 4

FIG.6

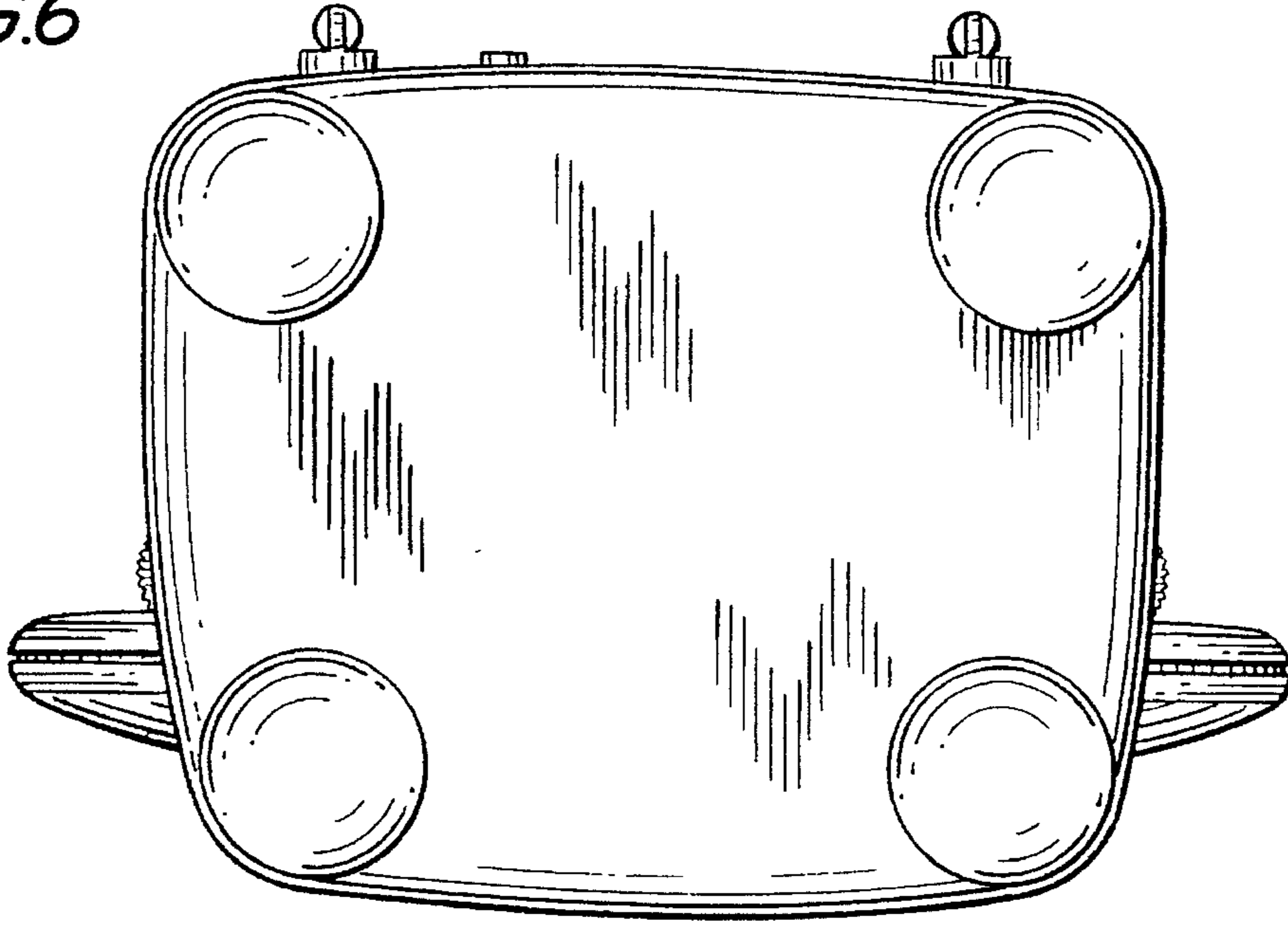

FIG.7

