



US00D378286S

United States Patent [19]
Chiu

[11] **Patent Number: Des. 378,286**

[45] **Date of Patent: **Mar. 4, 1997**

[54] **MINIATURE HOUSE DECORATION**

D. 195,723 7/1963 Banck D11/122
D. 216,704 3/1970 Mallory D11/122

[76] Inventor: **Li-Mei Chiu**, No. 67 Hong Nan St.,
Kuan Nan Village, Kung Kuan Hsiang,
Miaoli, Taiwan

Primary Examiner—Dominic Simone
Attorney, Agent, or Firm—Don B. Finkelstein

[**] Term: **14 Years**

[57] **CLAIM**

[21] Appl. No.: **42,610**

The ornamental design for a miniature house decoration, as shown and described.

[22] Filed: **Aug. 14, 1995**

DESCRIPTION

[52] U.S. Cl. D11/121; D11/125; D11/157;
D11/114

[58] **Field of Search** D11/117, 121,
D11/122, 125, 157; D25/1, 7, 17, 22; D21/114;
428/7

FIG. 1 is a left front perspective view of a miniature house decoration showing my new design;
FIG. 2 is a right side elevational view thereof;
FIG. 3 is a left side elevational view thereof;
FIG. 4 is a top plan view thereof;
FIG. 5 is a bottom plan view thereof;
FIG. 6 is a front elevational view thereof; and,
FIG. 7 is a rear elevational view thereof.

[56] **References Cited**

U.S. PATENT DOCUMENTS

D. 148,881 3/1948 Lawn D11/122
D. 164,450 9/1951 Rosenkranz et al. D11/122
D. 170,940 11/1953 Petry D11/125

1 Claim, 6 Drawing Sheets

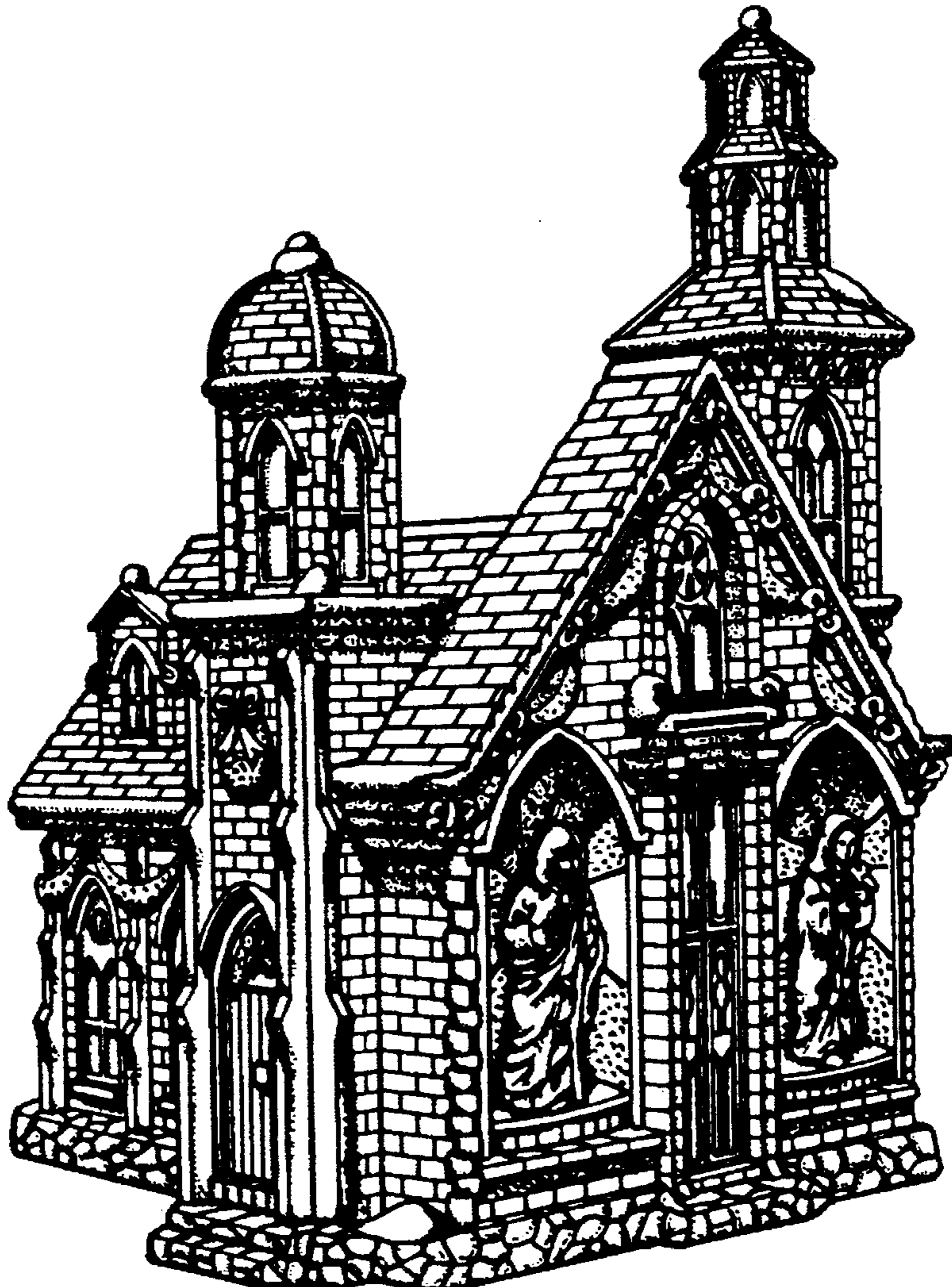

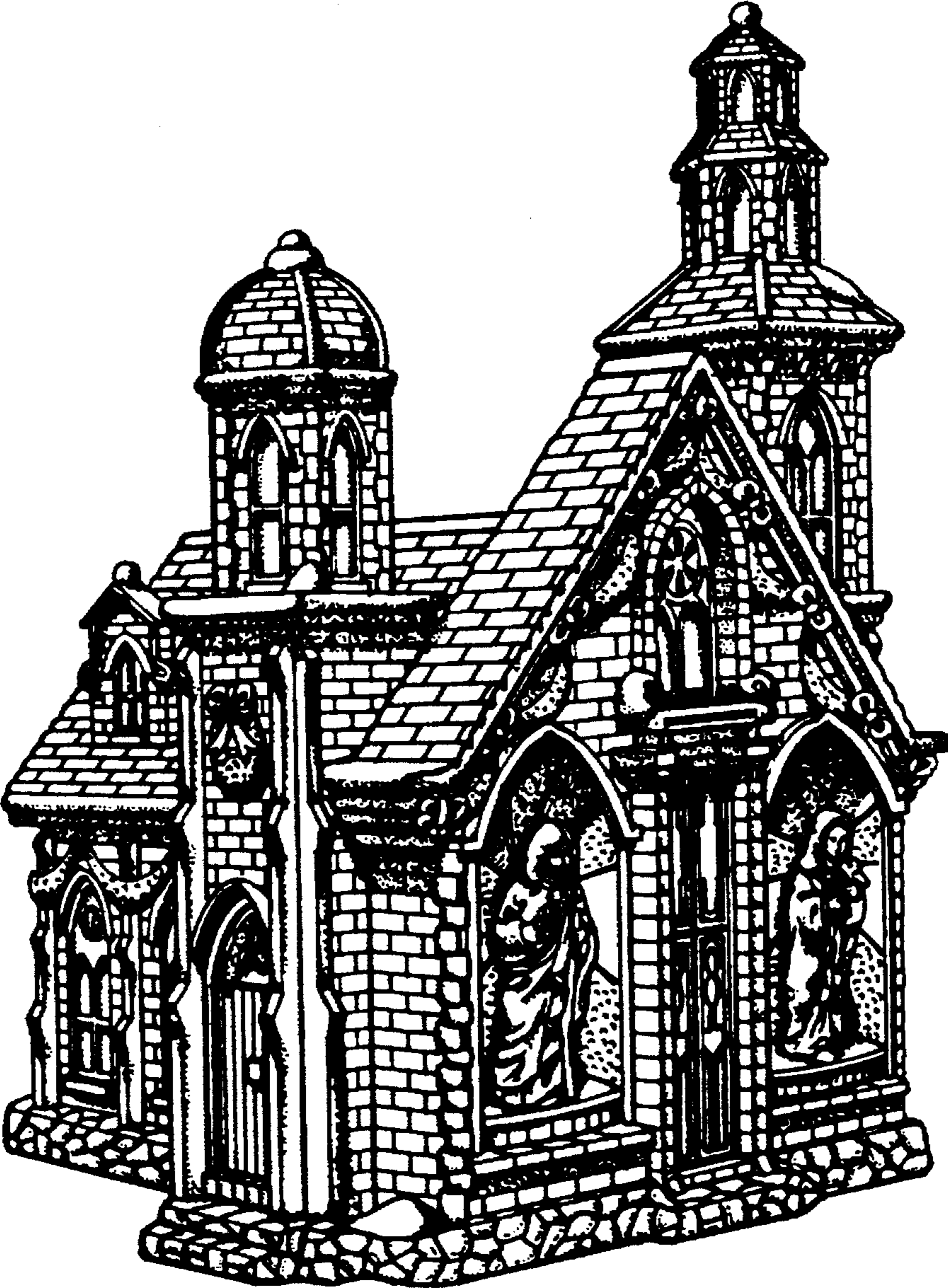

FIG. 1

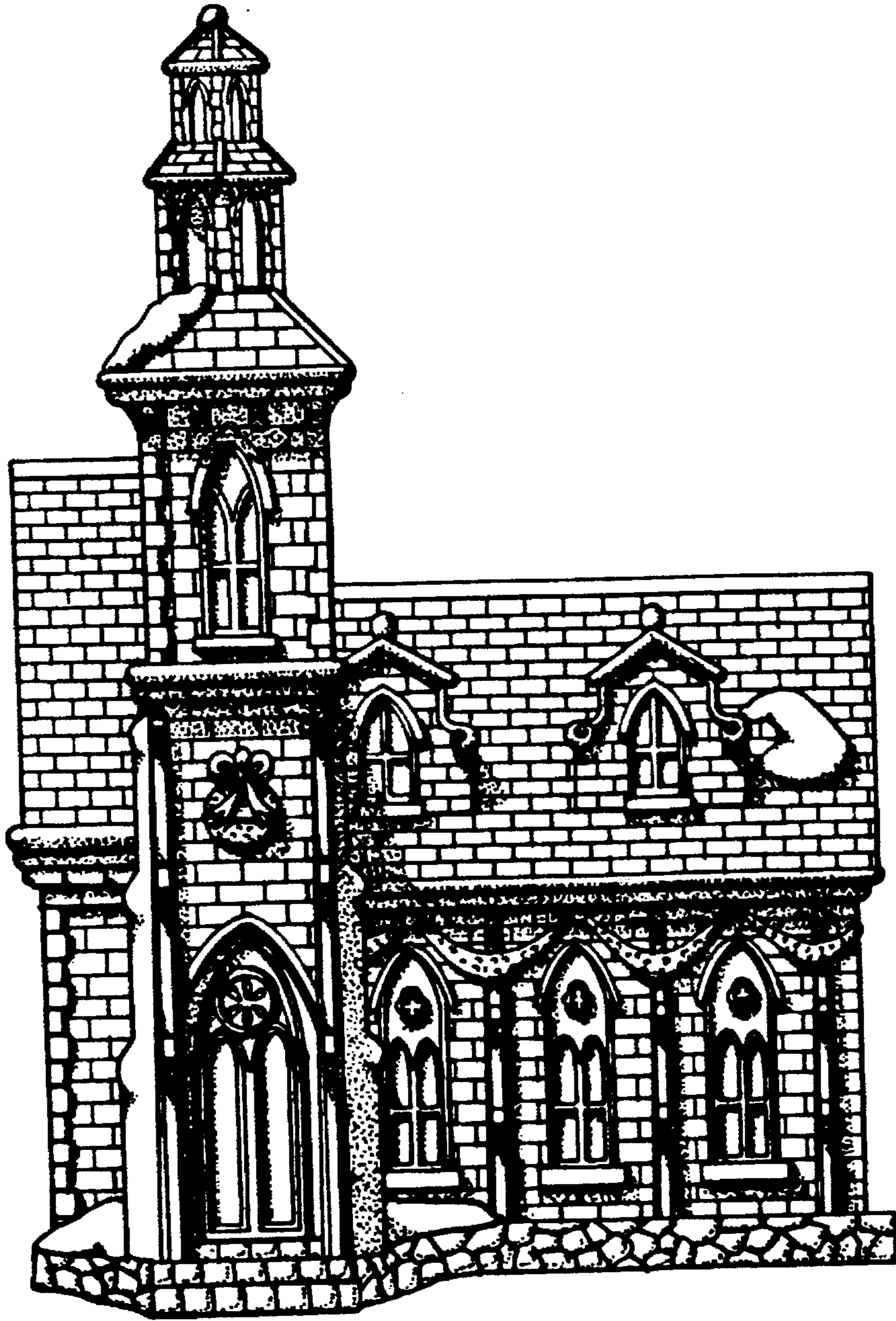

FIG. 2

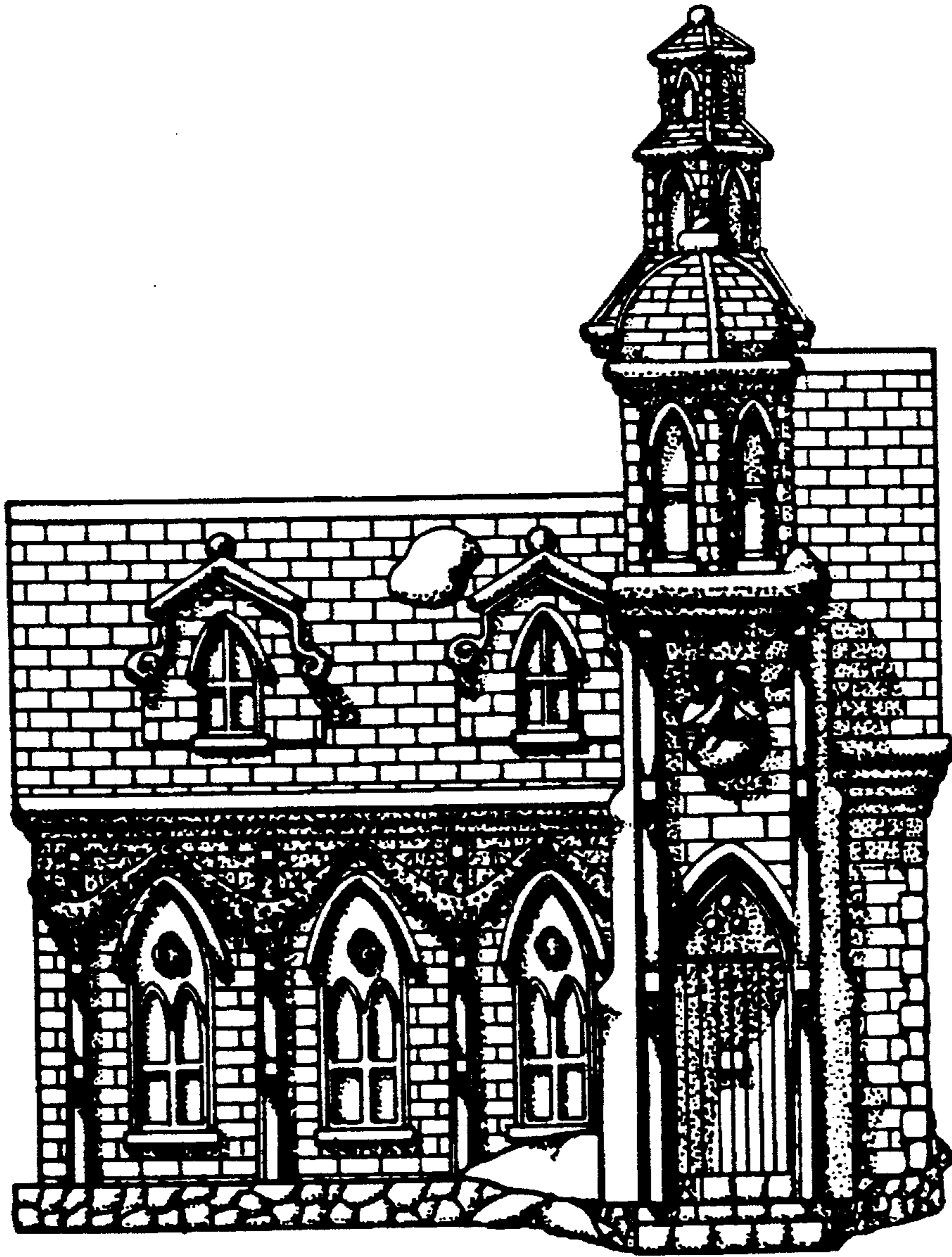

FIG. 3

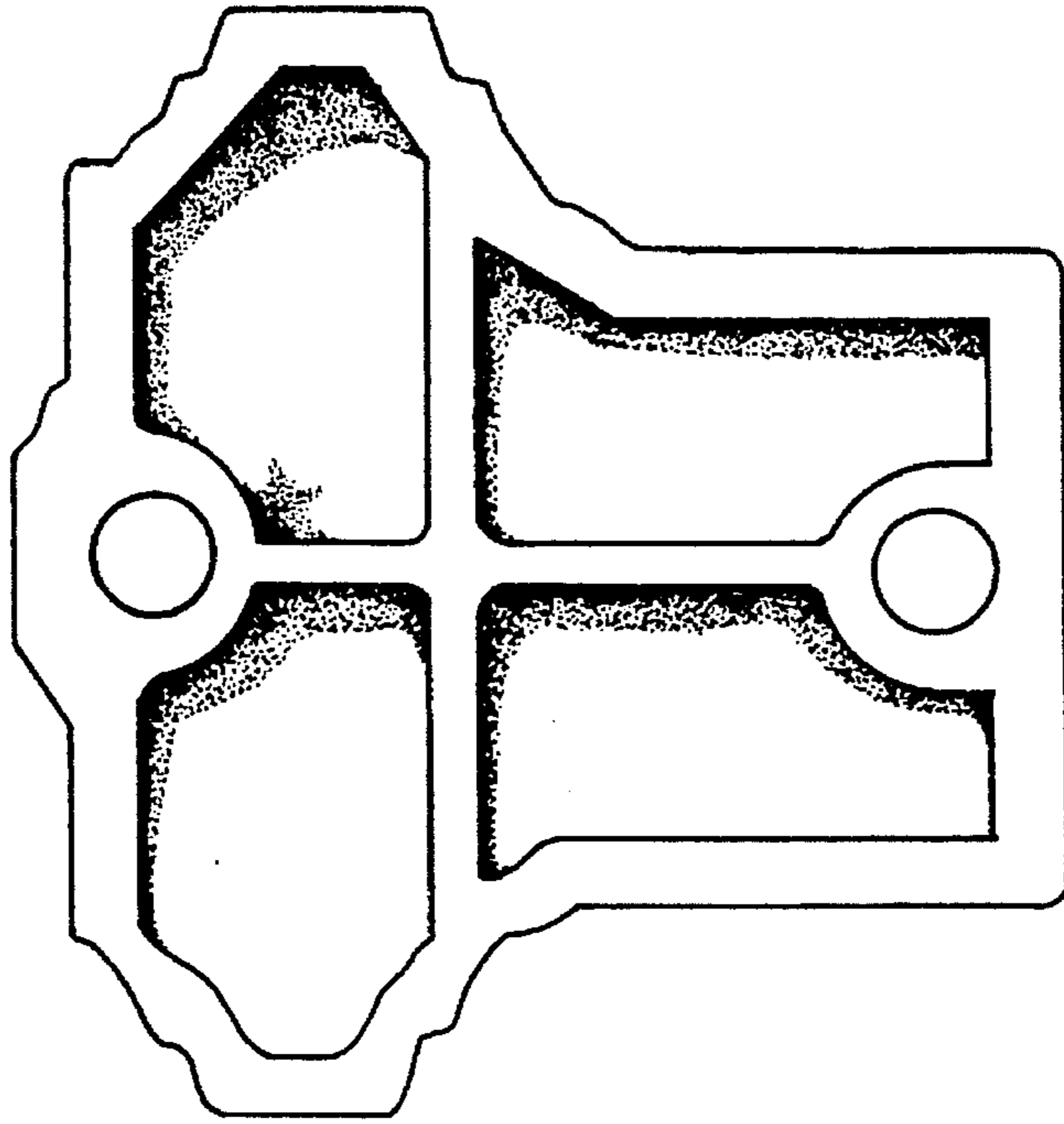

FIG. 5

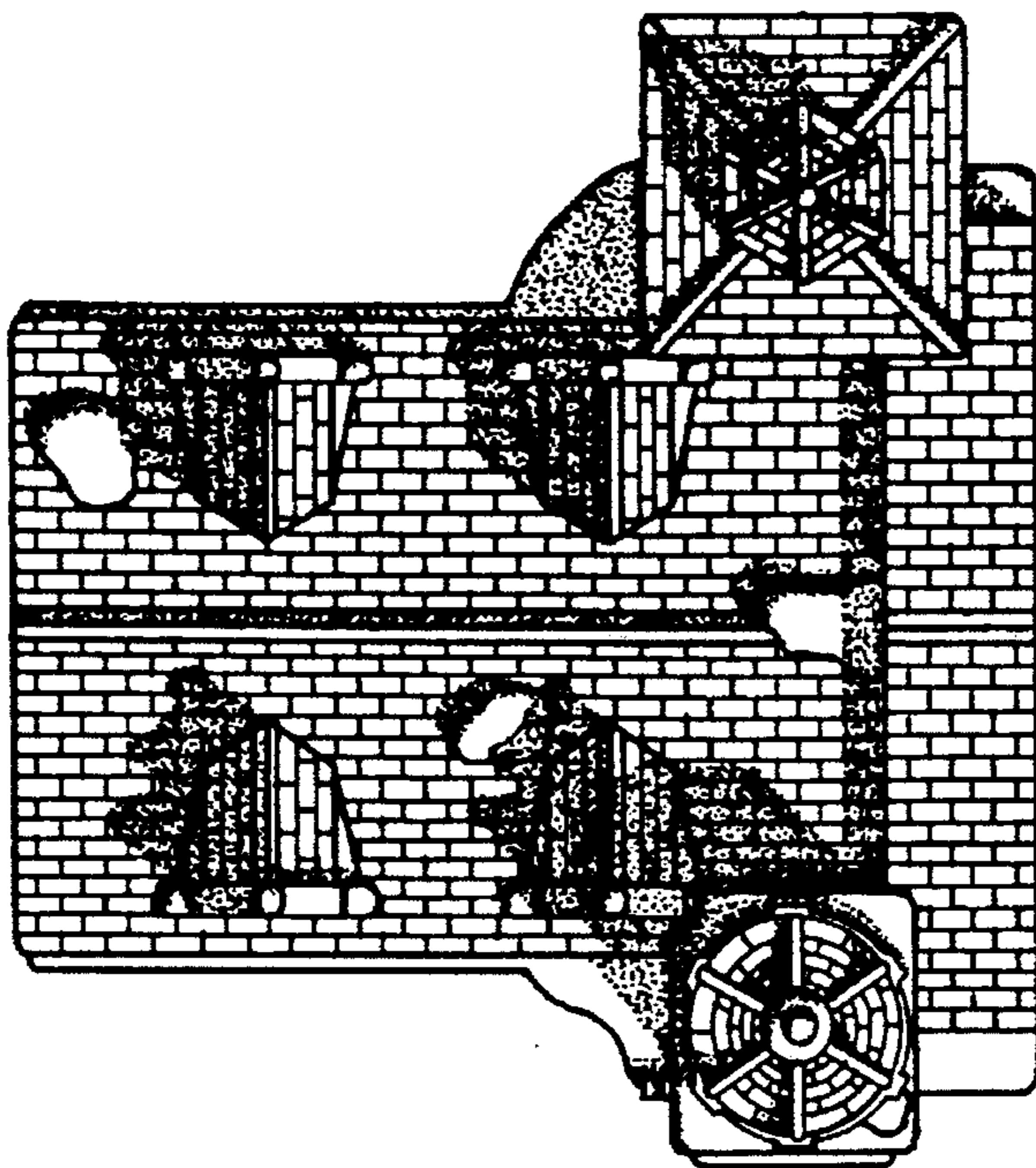

FIG. 4

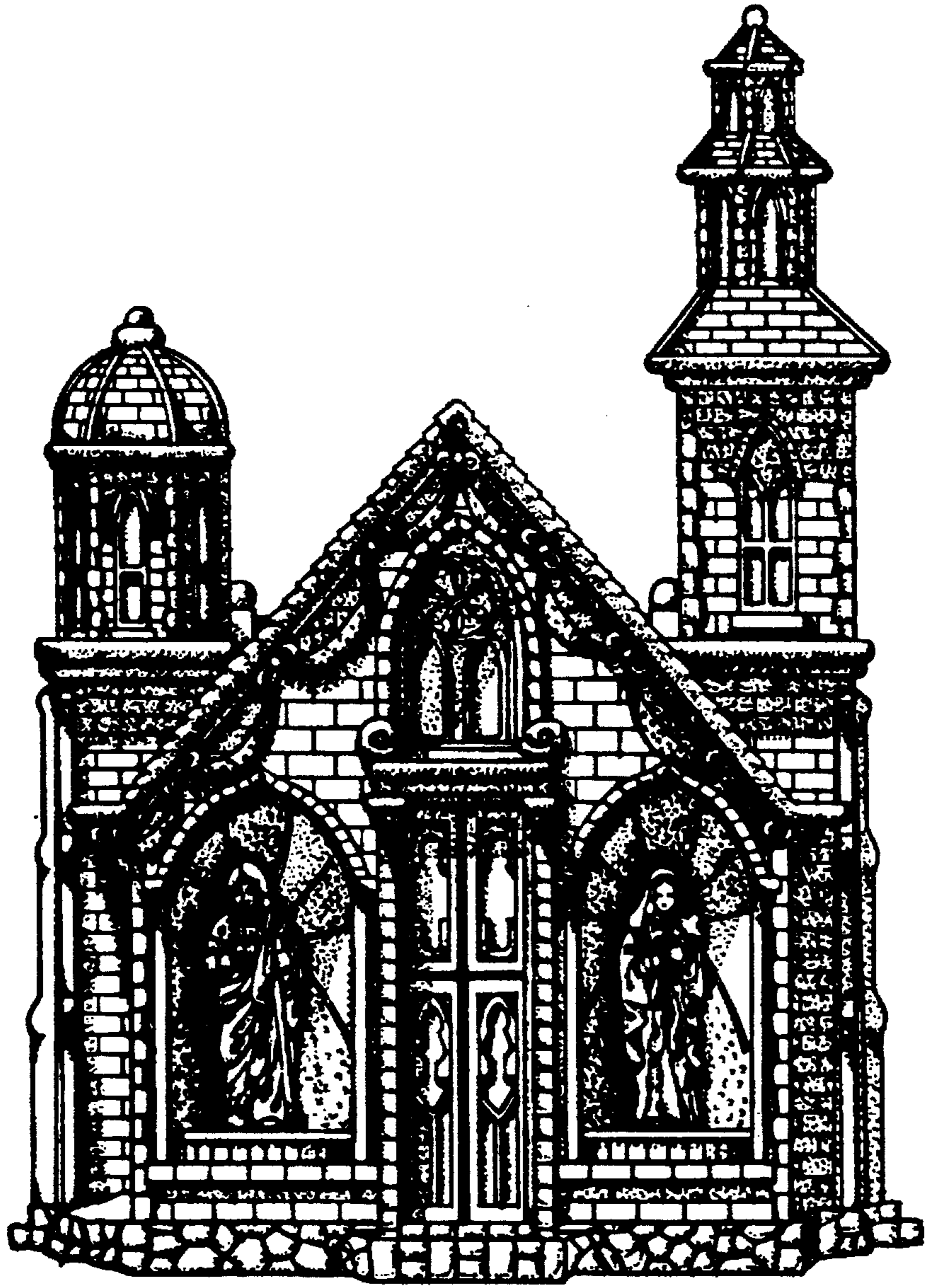

FIG. 6

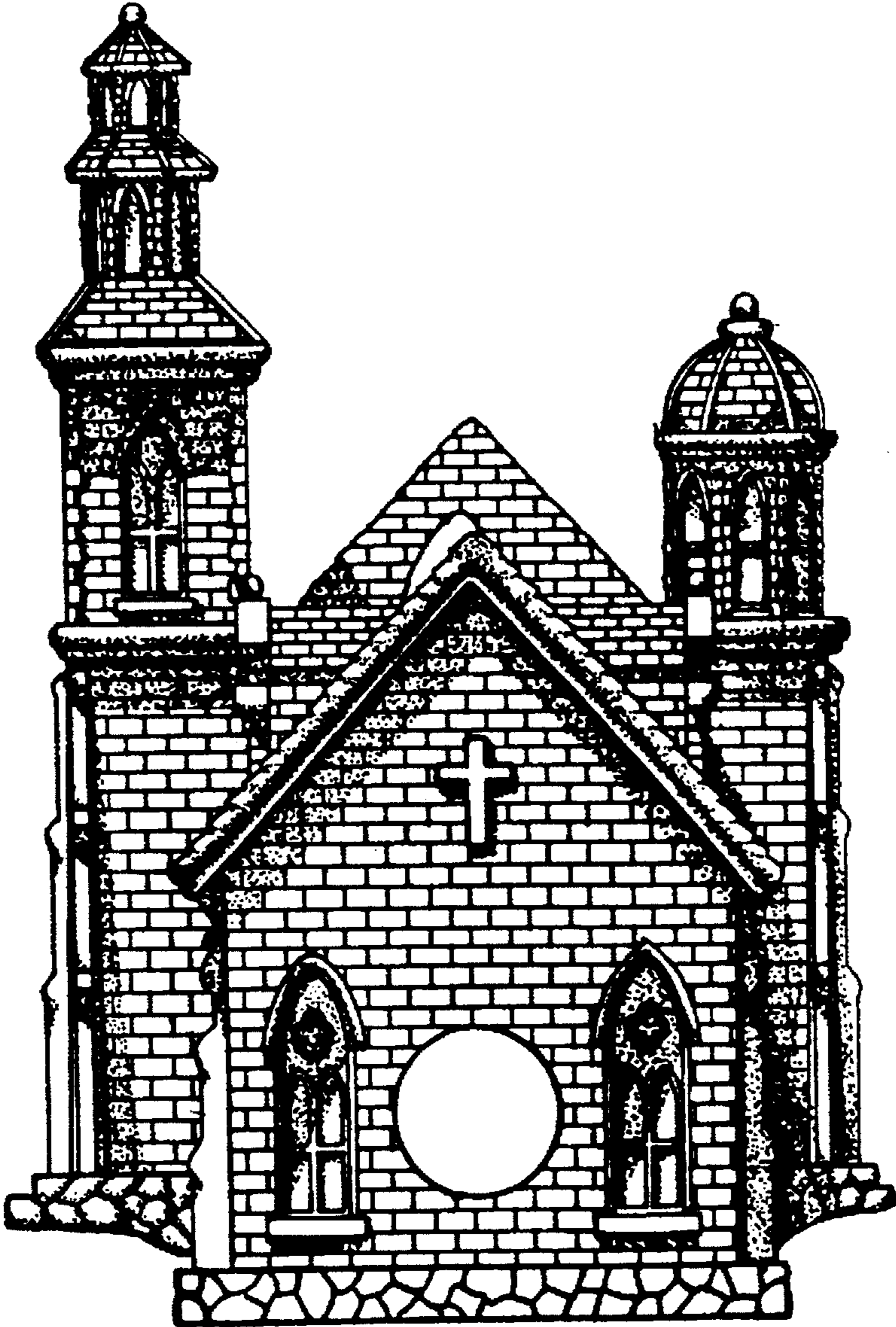

FIG. 7