



US00D378284S

# United States Patent [19]

Grilk et al.

[11] Patent Number: **Des. 378,284**

[45] Date of Patent: **\*\*Mar. 4, 1997**

[54] **LIQUID LEVEL SENDER**

[75] Inventors: **Henry G. Grilk**, Lancaster; **David P. Riegel**, Landisville; **John A. Roser**, Elizabethtown, all of Pa.

[73] Assignee: **Datcon Instrument Co., Inc.**, East Petersburg, Pa.

[\*\*] Term: **14 Years**

[21] Appl. No.: **40,941**

[22] Filed: **Jun. 30, 1995**

[52] U.S. Cl. .... **D10/101**

[58] Field of Search ..... D10/101; 73/290 R, 73/292, 304 C, 304 R, 312, 313, 316, 320, 620, 863.01, 863.02, 863.11, 863.85, 864.25; 137/392; 200/51 R, 84 C; 340/438, 625; 364/509

[56] **References Cited**

**U.S. PATENT DOCUMENTS**

D. 352,010 11/1994 Curbbun ..... D10/101

5,138,881 8/1992 Riley et al. .... 73/304 R  
5,146,785 9/1992 Riley ..... 73/313  
5,156,047 10/1992 Tuma et al. .... 73/304 C  
5,477,727 12/1995 Koga ..... 73/304 C

*Primary Examiner*—Antoine Duval Davis  
*Attorney, Agent, or Firm*—Dan Williams

[57] **CLAIM**

The ornamental design for a liquid level sender, as shown and described.

**DESCRIPTION**

FIG. 1 is a top perspective view of our new design; FIG. 2 is a top plan view of our new design; FIG. 3 is a left side elevational view of our new design, the right side elevational view being a mirror image thereof; FIG. 4 is a front elevational view of our new design, the rear elevational view being a mirror image thereof; FIG. 5 is a bottom perspective view of our new design; and, FIG. 6 is a bottom plan view of our new design.

**1 Claim, 3 Drawing Sheets**

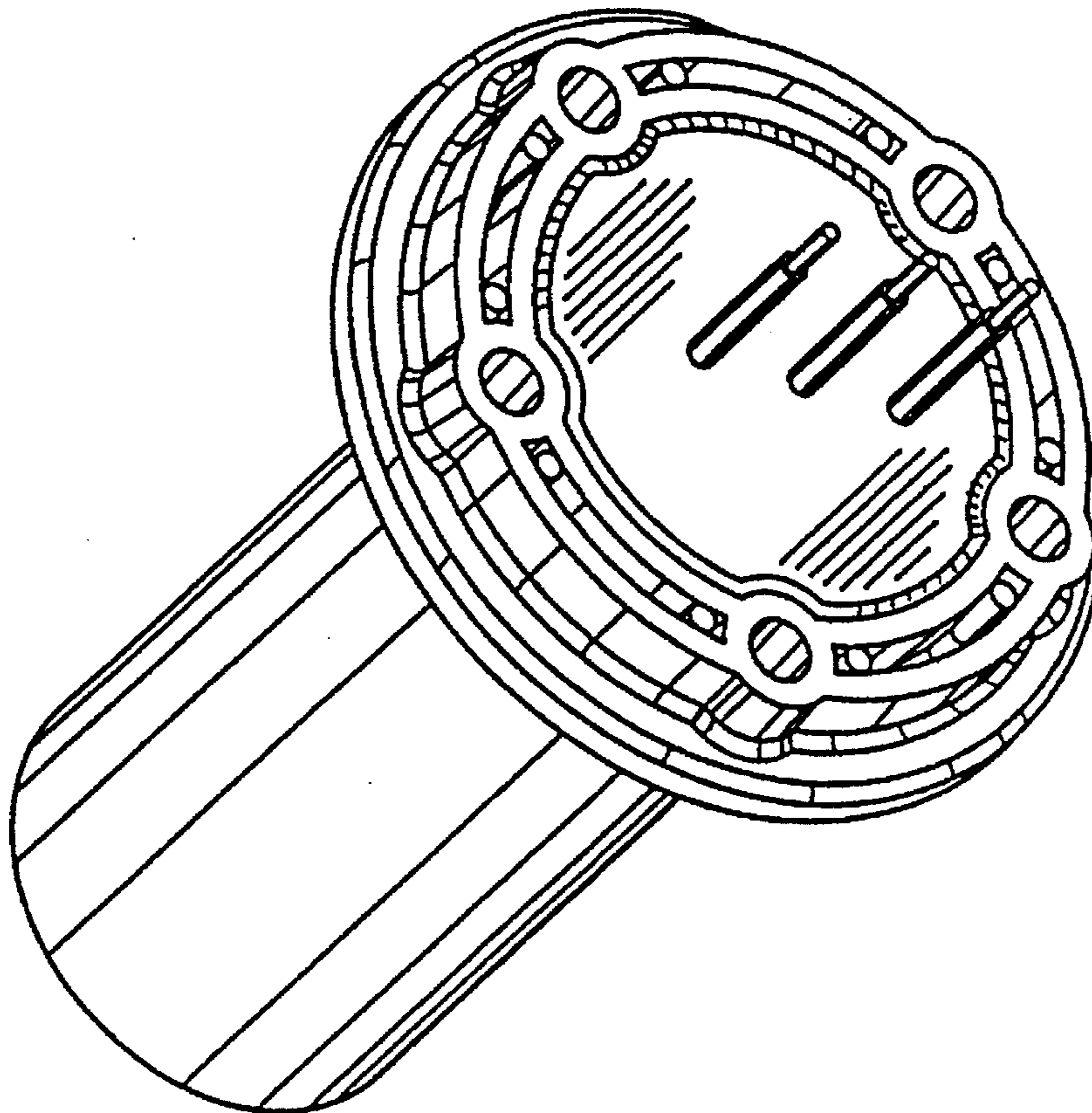

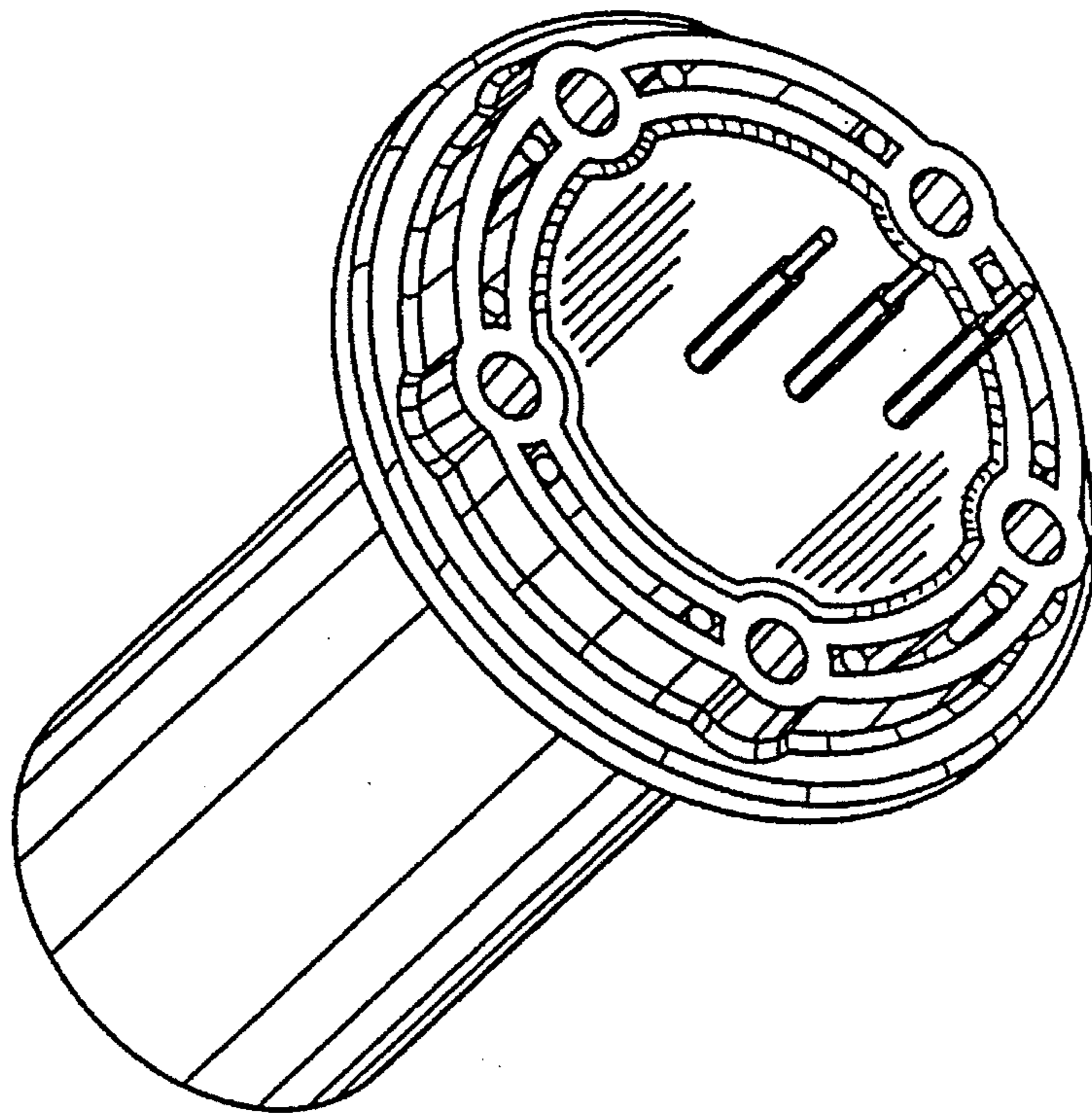

FIG. 1

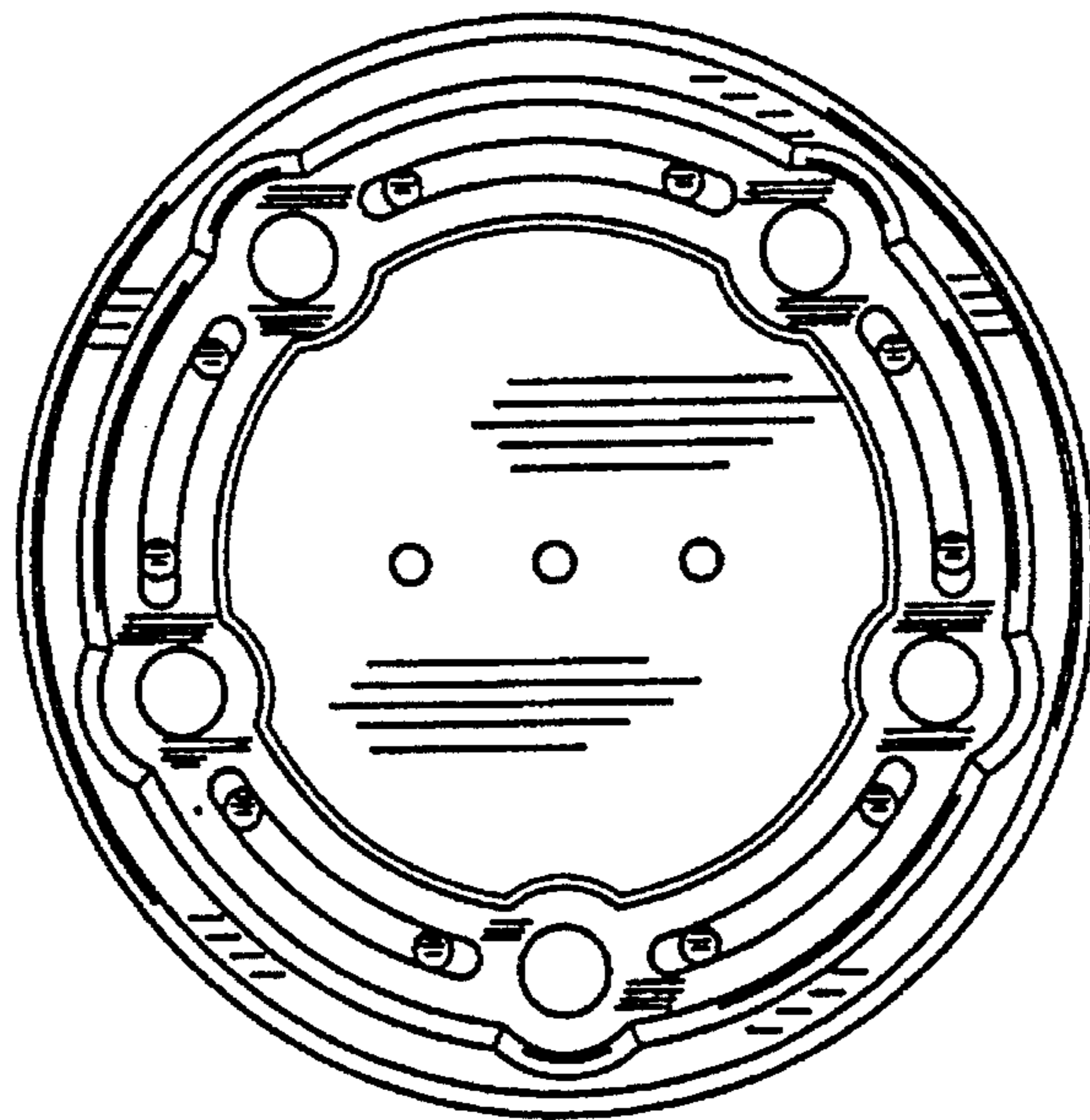

FIG. 2

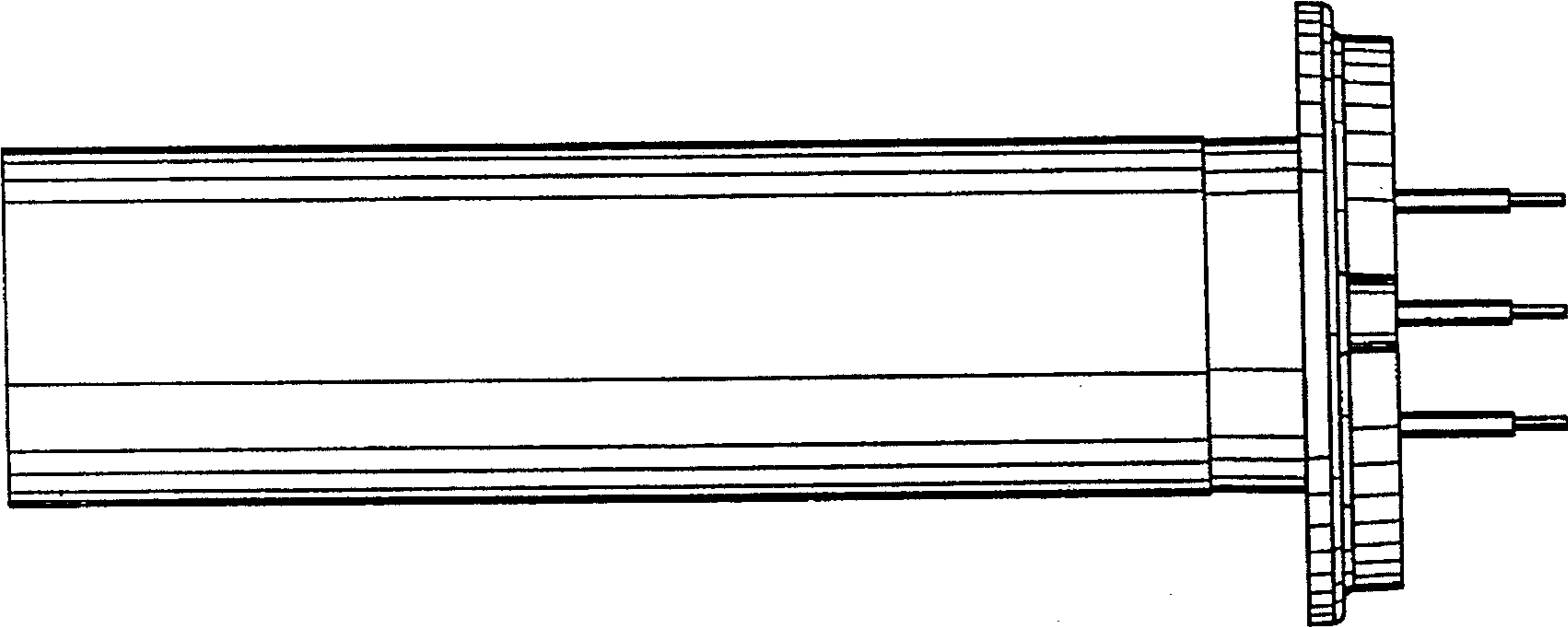

FIG. 3

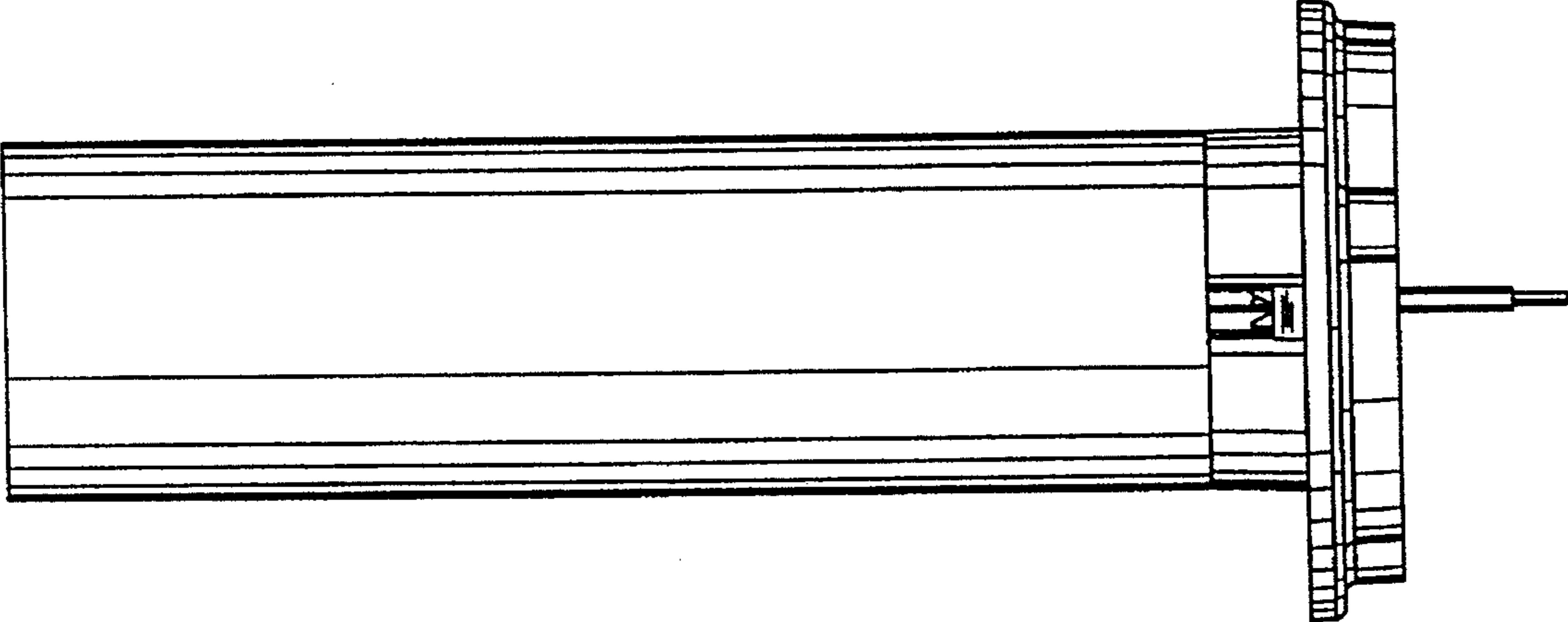

FIG. 4

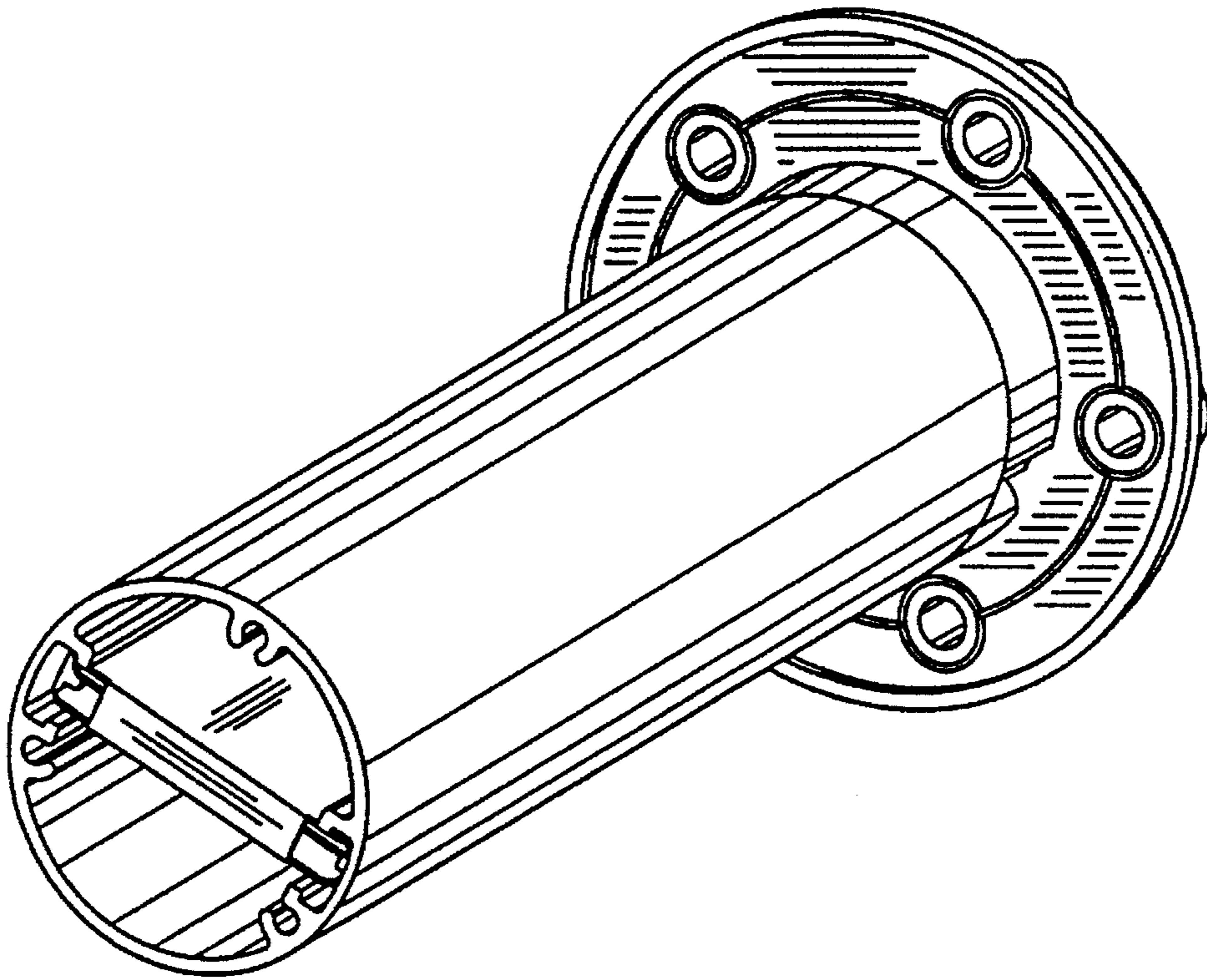

FIG. 5

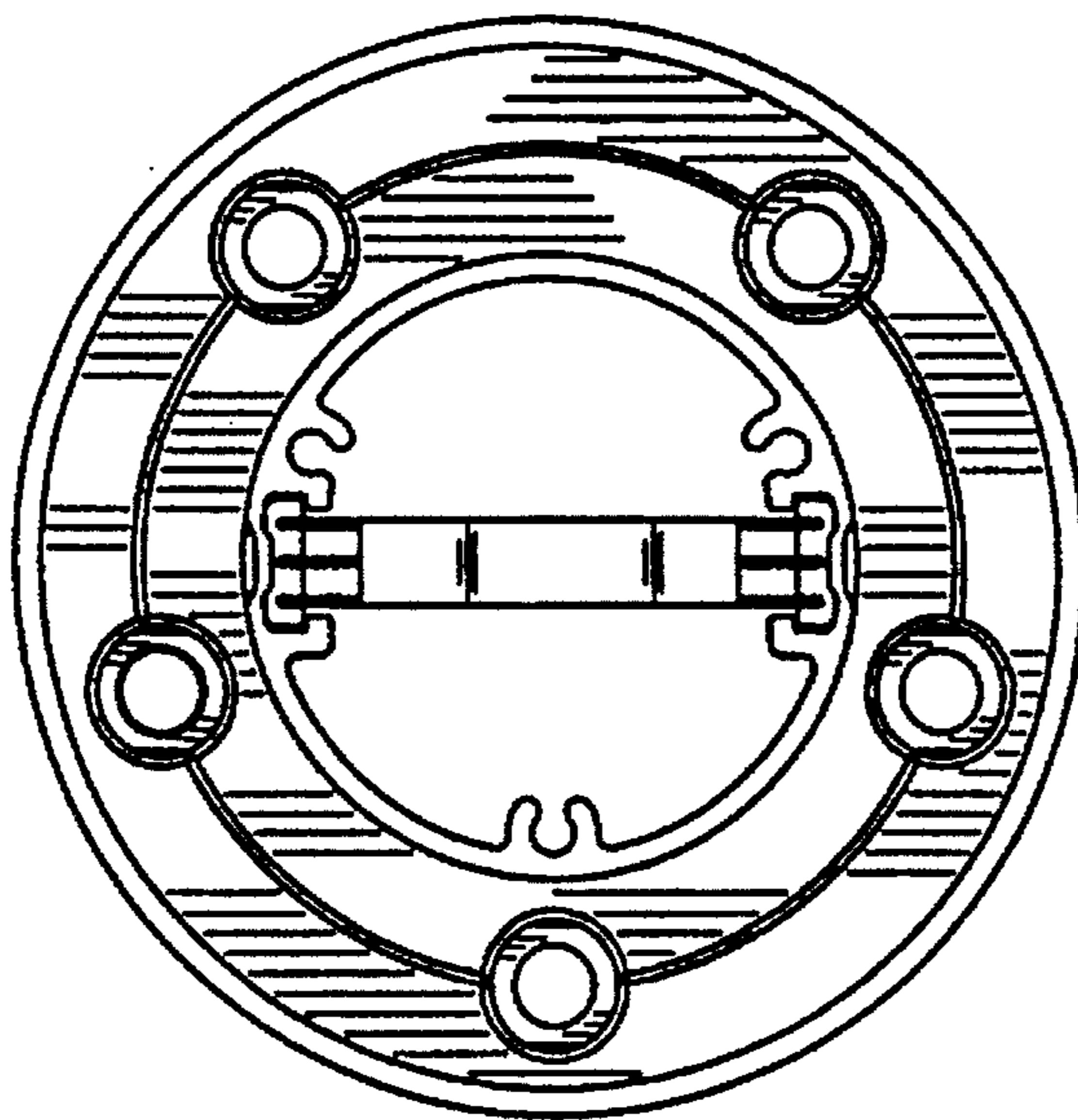

FIG. 6