



US00D378190S

**United States Patent** [19]  
**Sachs**

[11] **Patent Number: Des. 378,190**  
[45] **Date of Patent: \*\*Feb. 25, 1997**

[54] **BUCKLE ELEMENT**

**DESCRIPTION**

[75] Inventor: **Isaac Sachs**, Dollard-Des-Ormeaux,  
Canada  
[73] Assignee: **Diamond Communication Products,  
Inc.**, Garwood, N.J.  
[\*\*] Term: **14 Years**  
[21] Appl. No.: **47,851**  
[22] Filed: **Dec. 13, 1995**  
[52] U.S. Cl. .... **D8/383**  
[58] Field of Search ..... D11/200, 231;  
D8/382, 383, 364, 366, 373; 248/231; D13/129

FIG. 1 is a left side, top and front perspective view of a buckle element showing my new design;  
FIG. 2 is a front elevational view thereof;  
FIG. 3 is a right side elevational view thereof;  
FIG. 4 is a left side elevational view thereof;  
FIG. 5 is a top plan view thereof;  
FIG. 6 is a bottom plan view thereof;  
FIG. 7 is a rear elevational view thereof;  
FIG. 8 is a left side, top and front perspective view of a buckle element showing a second embodiment of my new design;  
FIG. 9 is a front elevational view of FIG. 8;  
FIG. 10 is a right side elevational view of FIG. 8;  
FIG. 11 is a left side elevational view of FIG. 8;  
FIG. 12 is a top plan view of FIG. 8;  
FIG. 13 is a bottom plan view of FIG. 8;  
FIG. 14 is a rear elevational view of FIG. 8;  
FIG. 15 is a left side, top and front perspective view of a buckle element showing a third embodiment of my new design;  
FIG. 16 is a front elevational view of FIG. 15;  
FIG. 17 is a right side elevational view of FIG. 15;  
FIG. 18 is a left side elevational view of FIG. 15;  
FIG. 19 is a top plan view of FIG. 15;  
FIG. 20 is a bottom plan view of FIG. 15; and,  
FIG. 21 is a rear elevational view of FIG. 15.

[56] **References Cited**

**U.S. PATENT DOCUMENTS**

D. 308,017	5/1990	Fujioka	.....	D8/382
D. 308,819	6/1990	Anscher	.....	D8/382
D. 310,020	8/1990	Fujioka	.....	D8/382
D. 314,359	2/1991	Viglianti et al.	.....	D11/200
D. 331,358	12/1992	Sachs	.....	D8/394
D. 344,448	2/1994	Sachs	.....	
2,775,010	12/1956	Bedford, Jr.	.....	D8/382

*Primary Examiner*—Ralf Seifert  
*Attorney, Agent, or Firm*—Foley & Lardner

[57] **CLAIM**

The ornamental design for a “buckle element”, as shown and described.

**1 Claim, 3 Drawing Sheets**

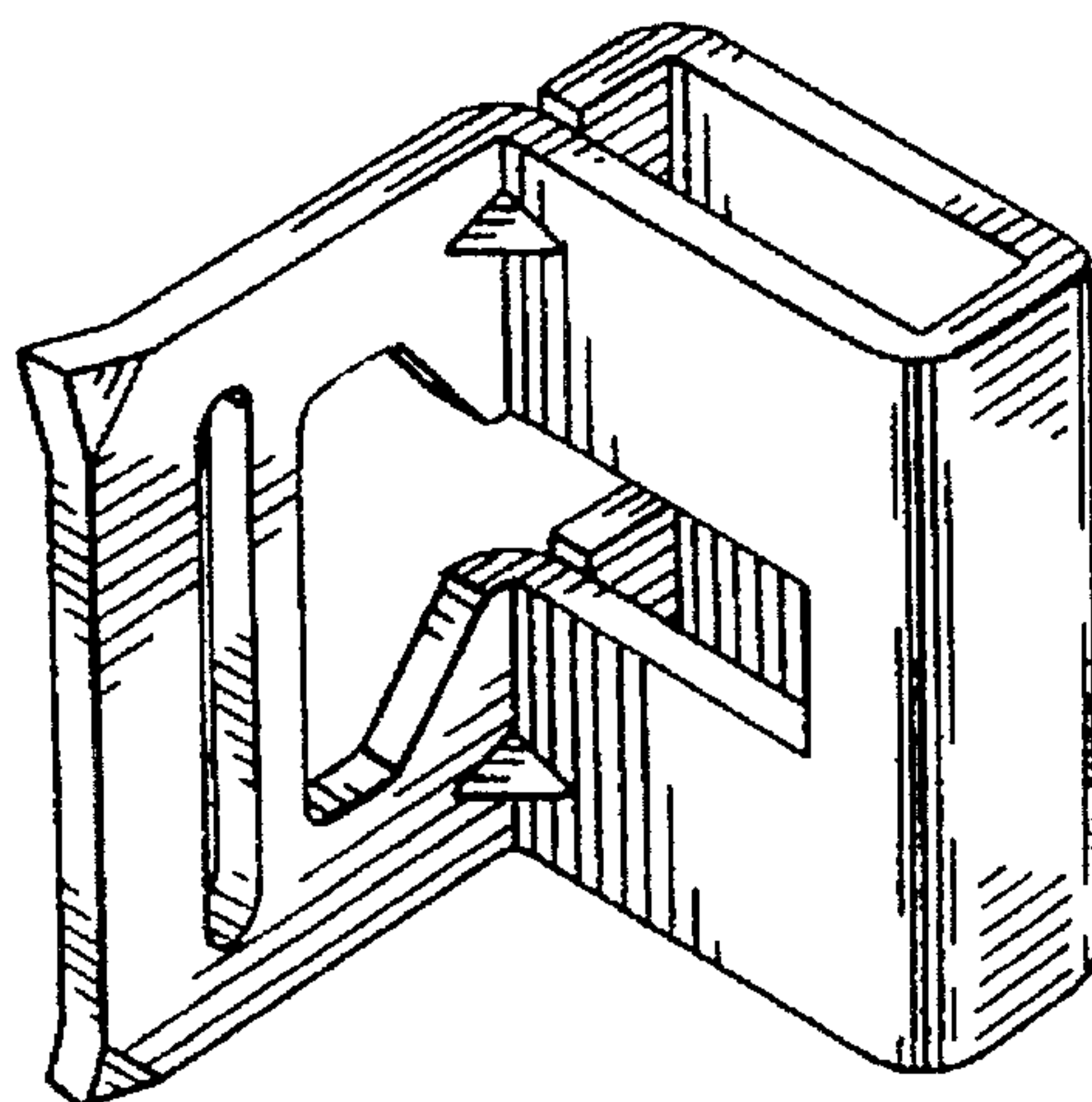

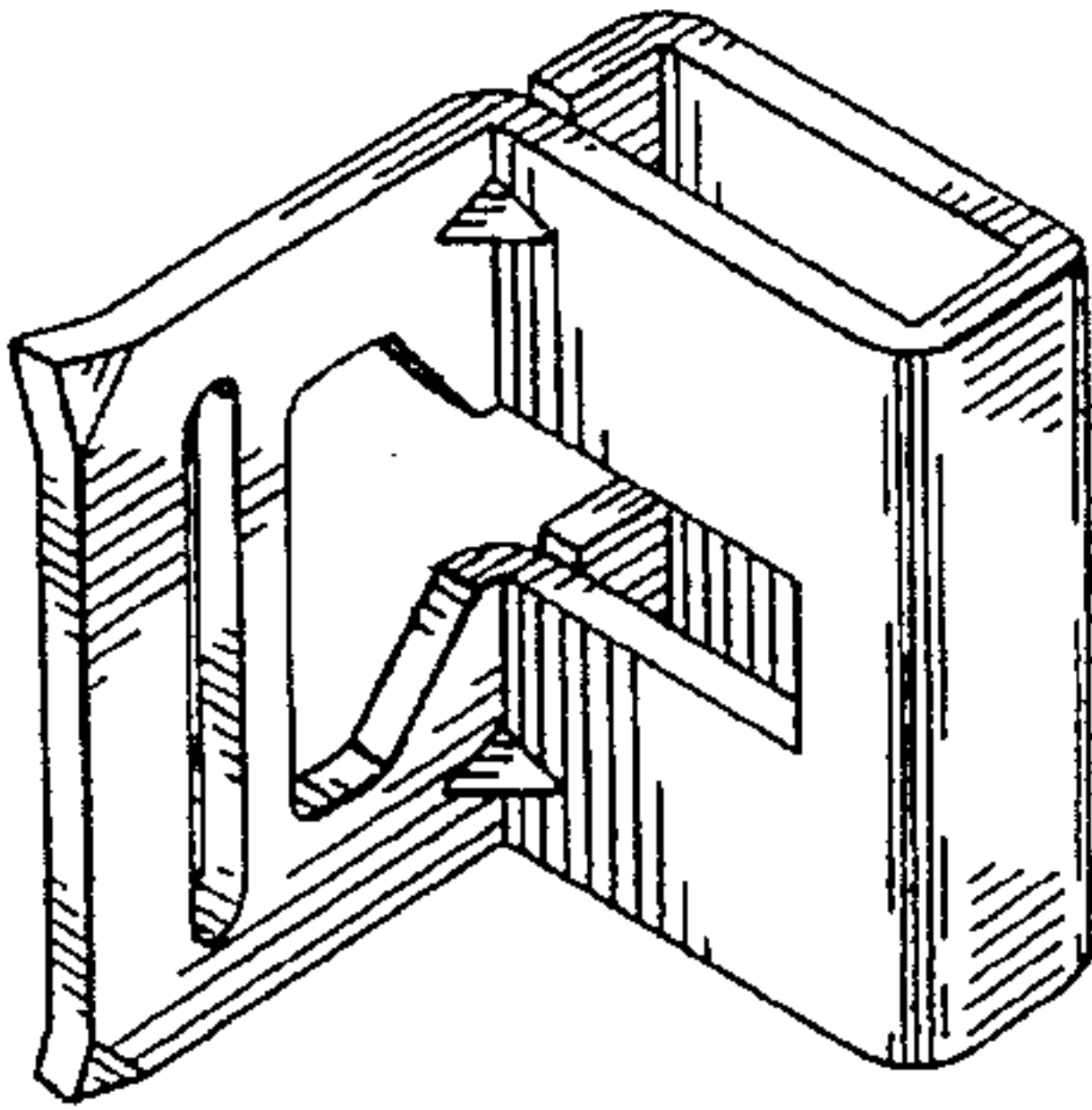

FIG. 1

FIG. 2

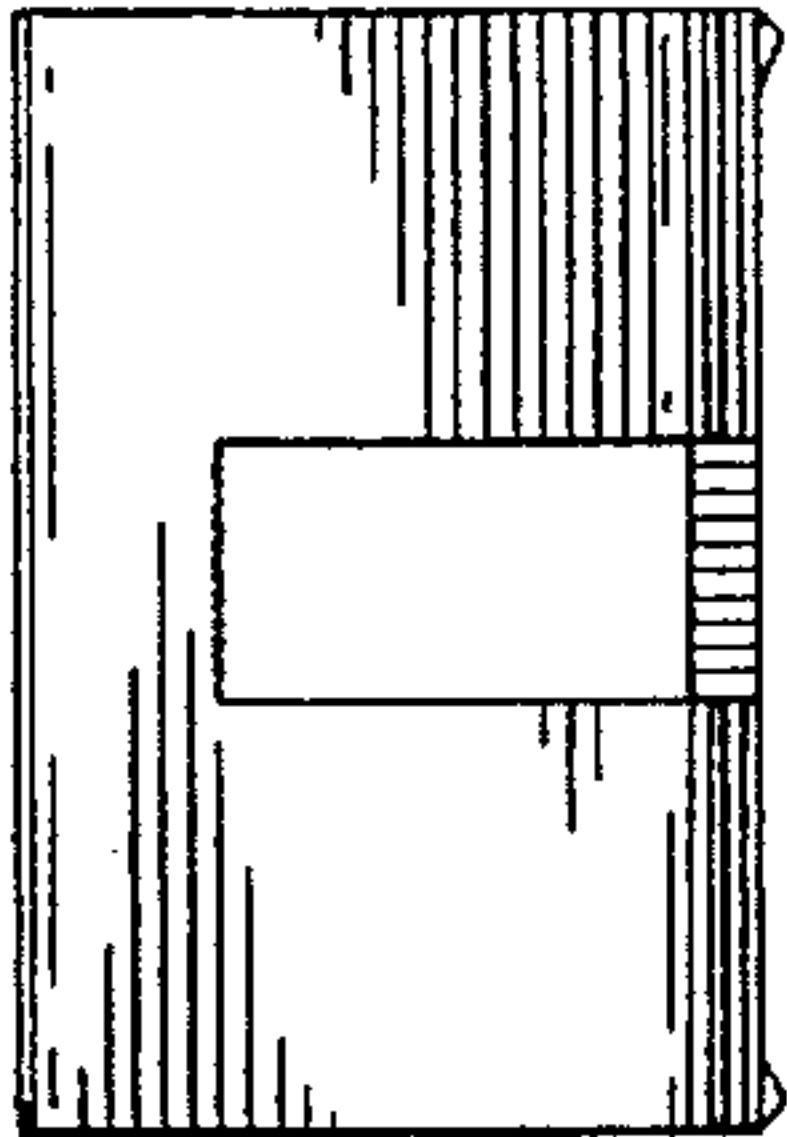
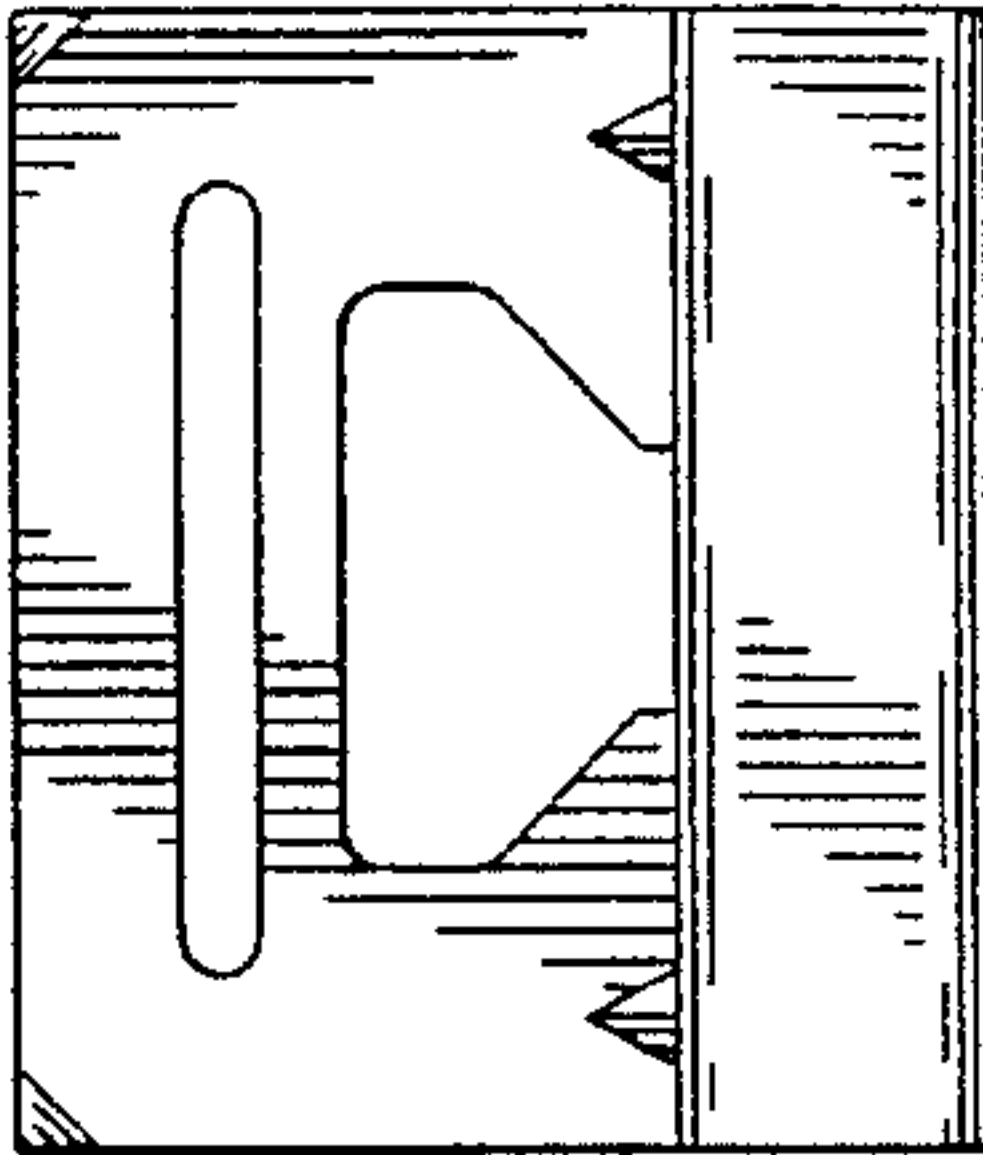

FIG. 3

FIG. 4

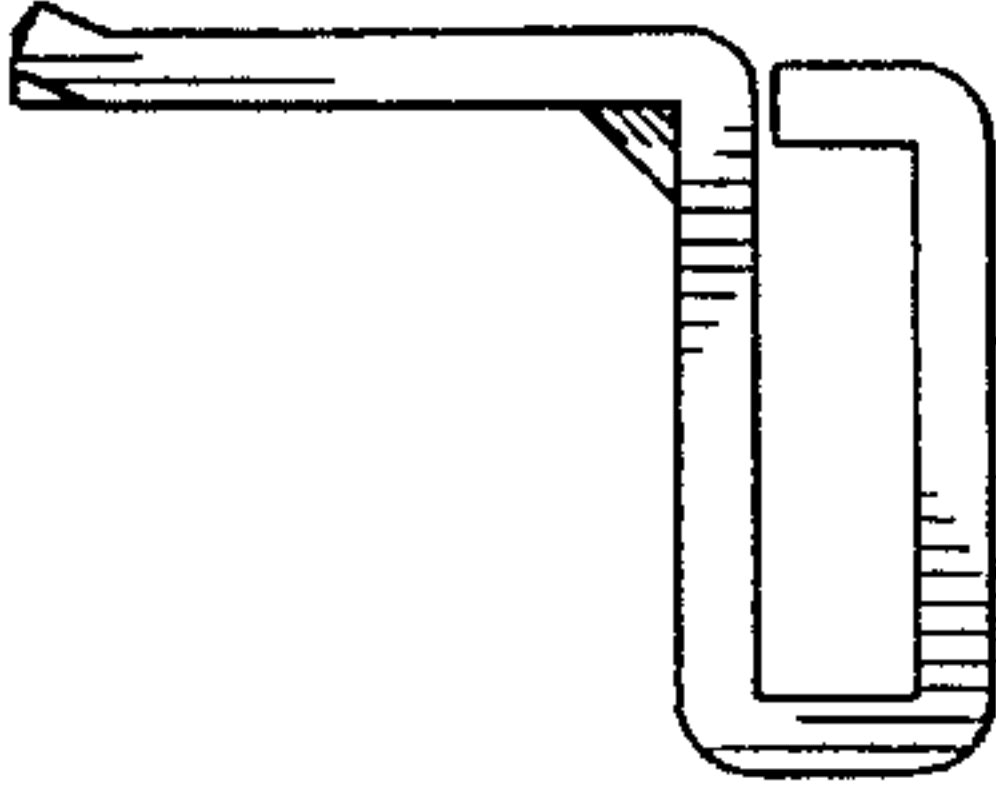
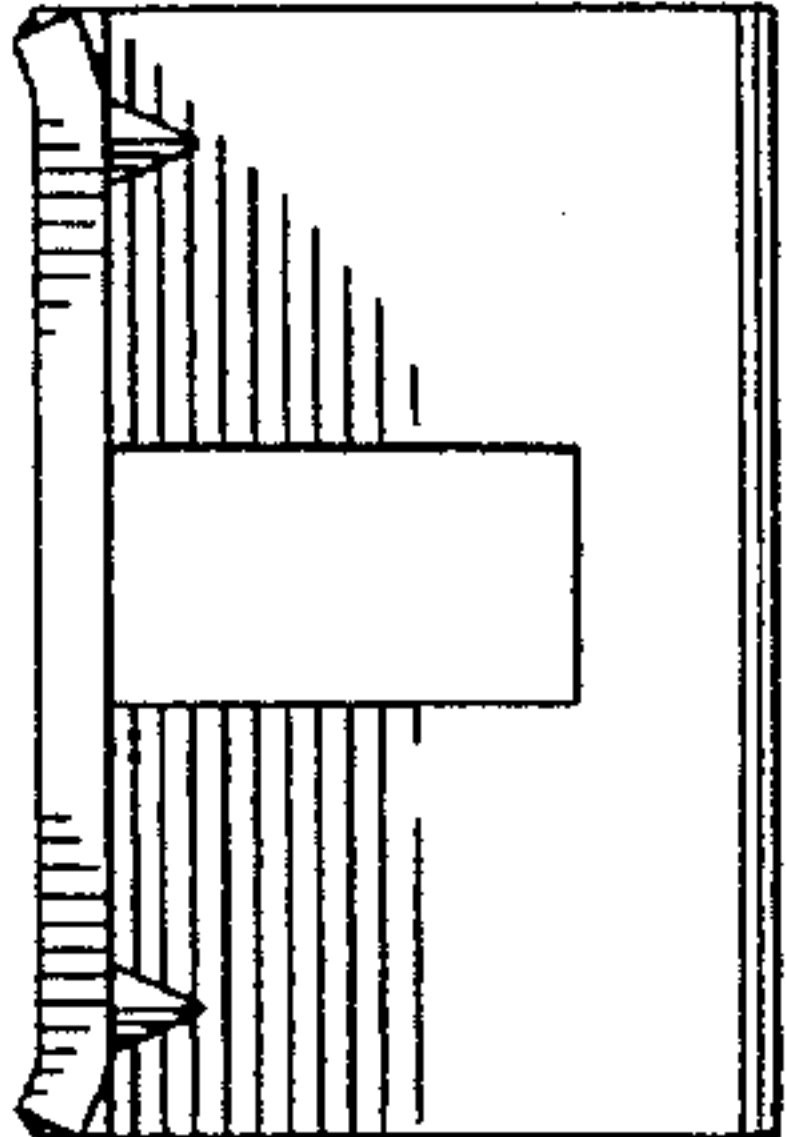

FIG. 5

FIG. 6

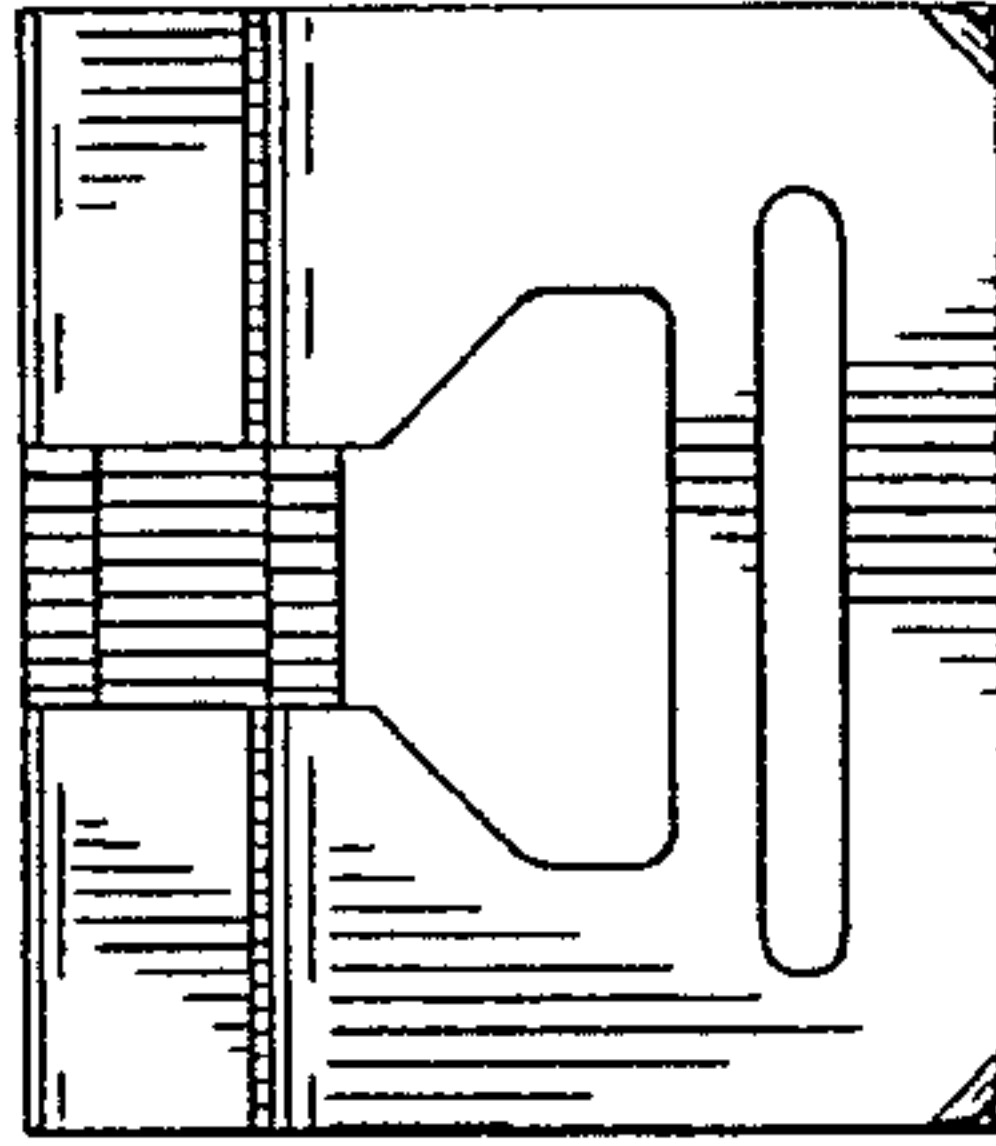
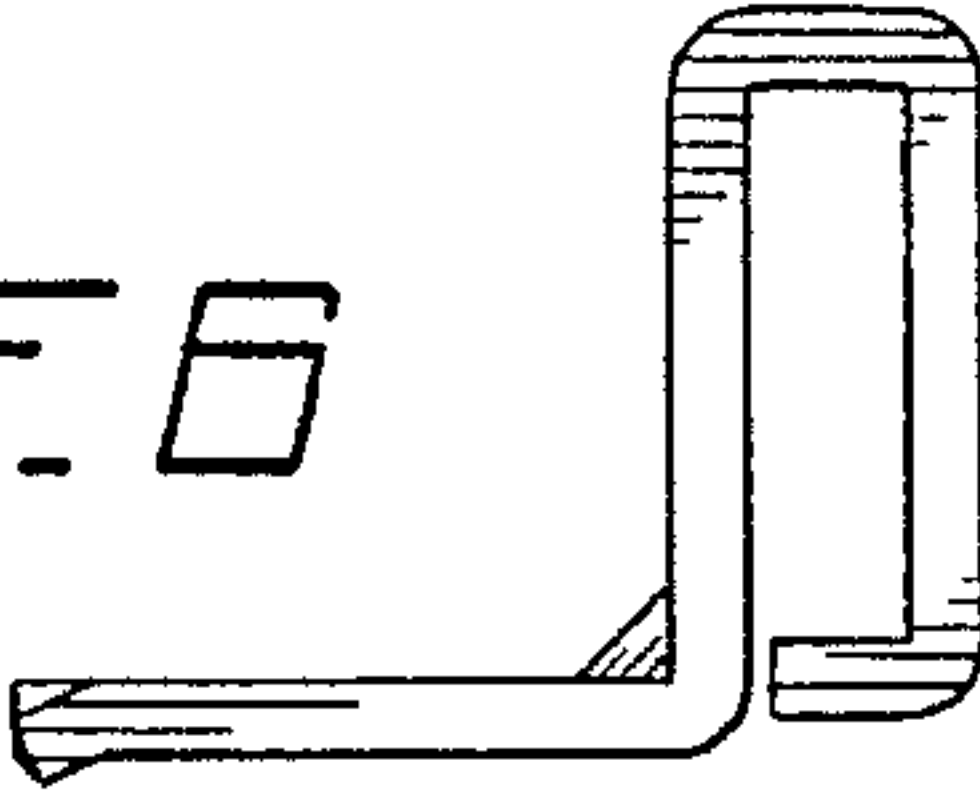
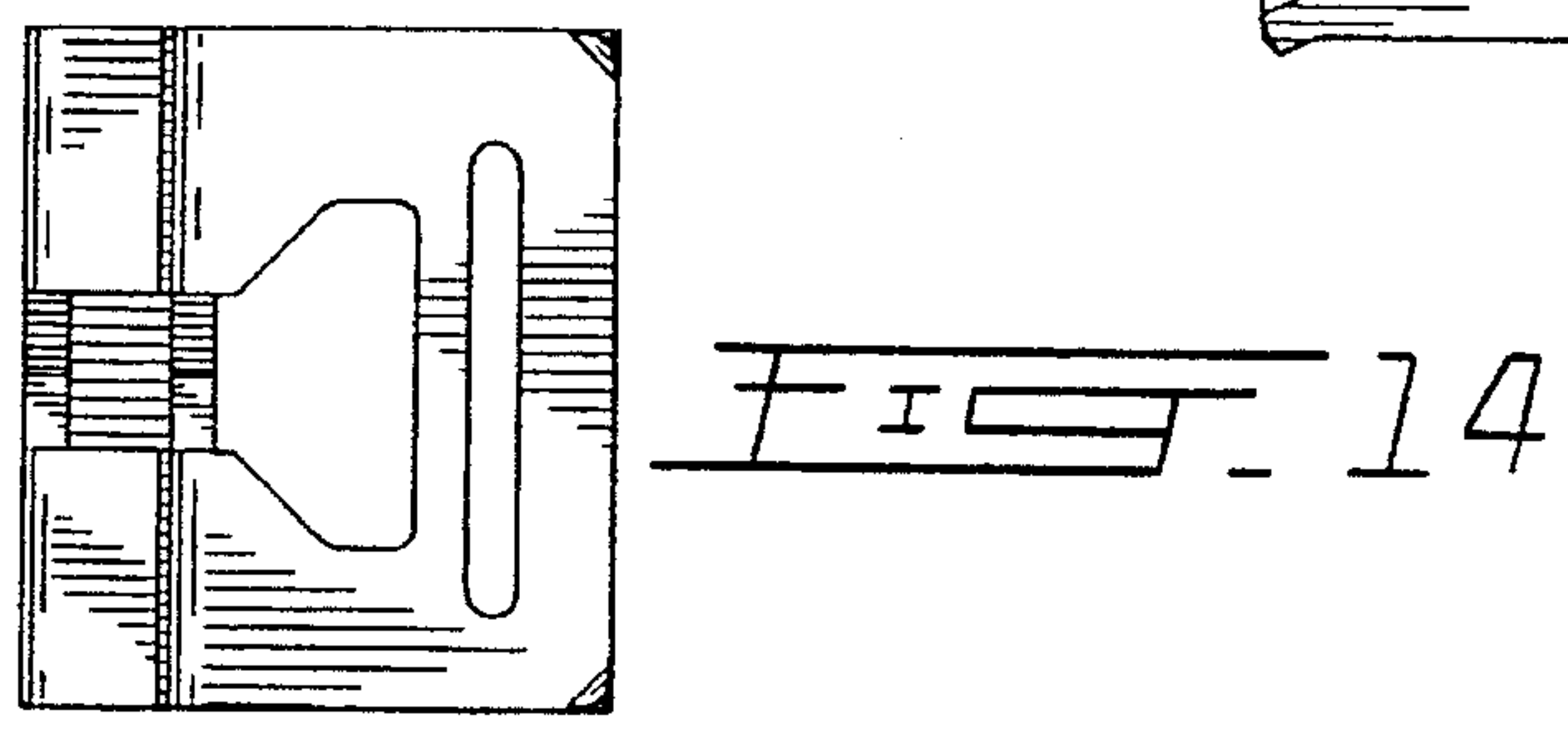
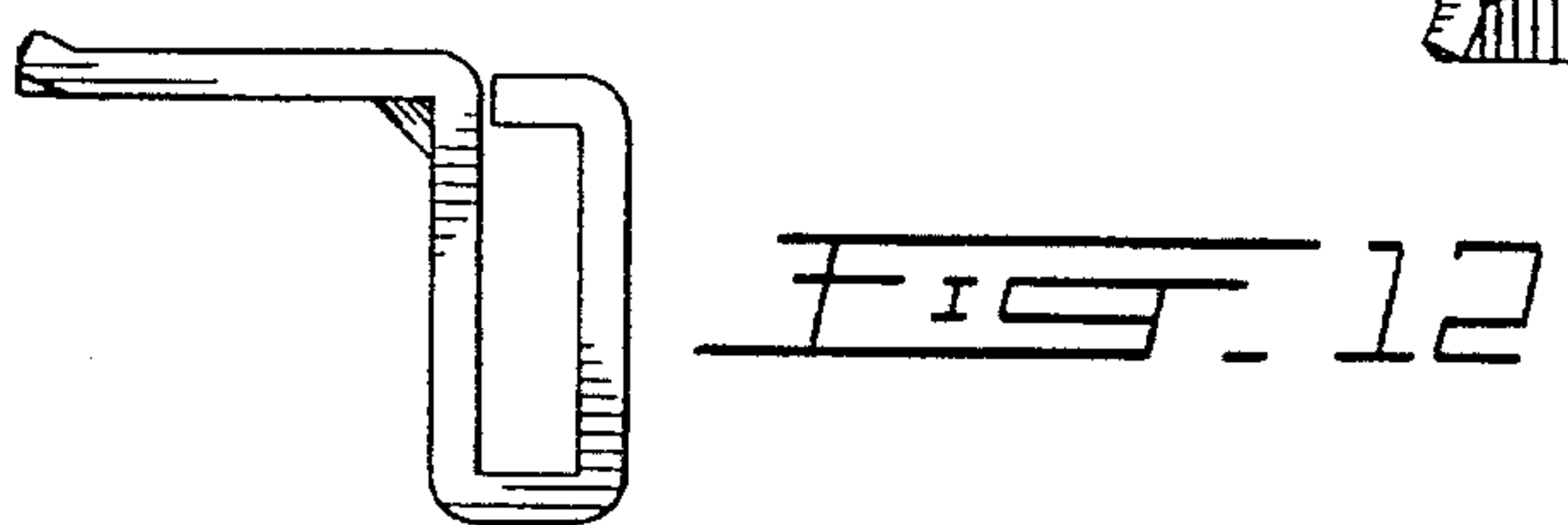
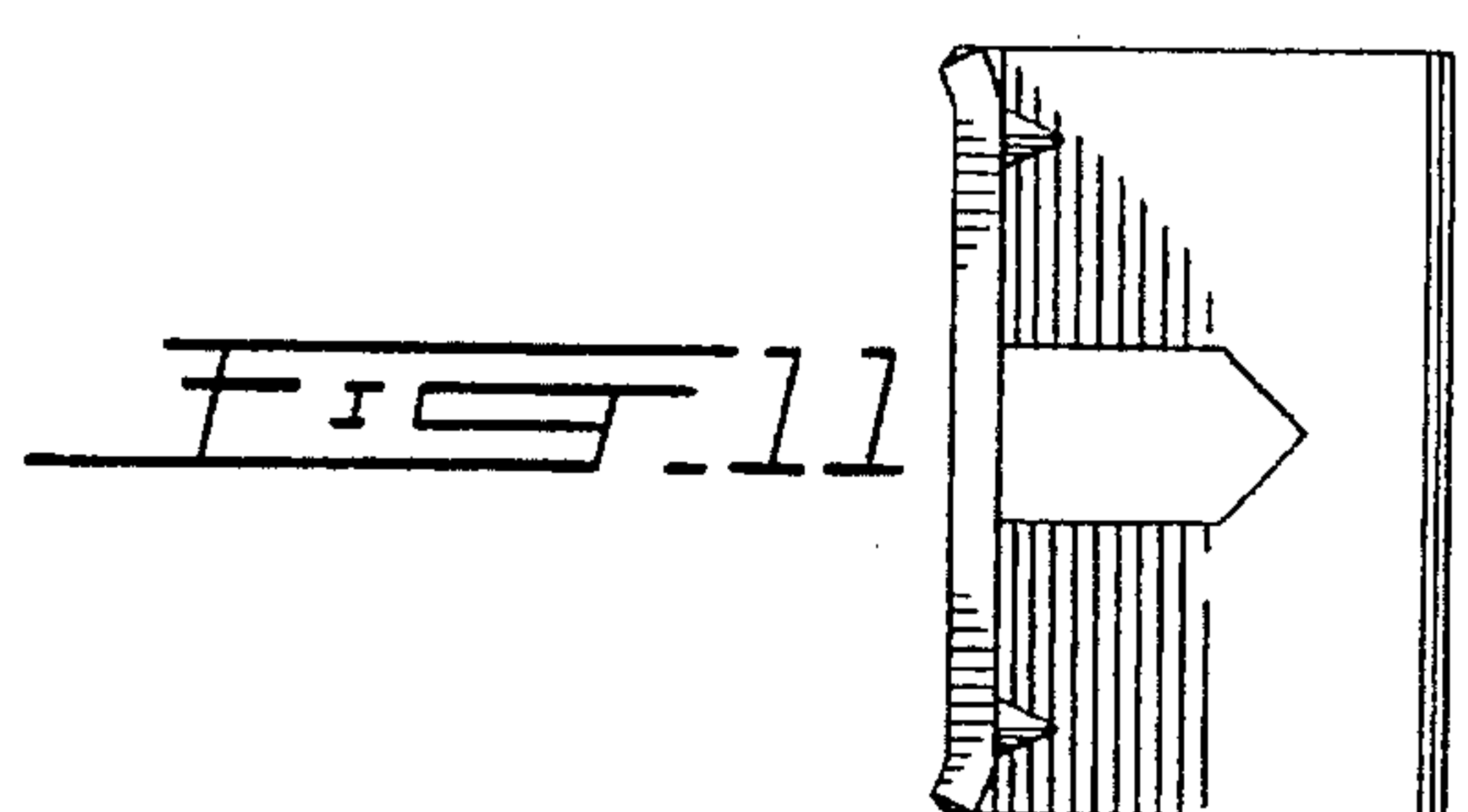
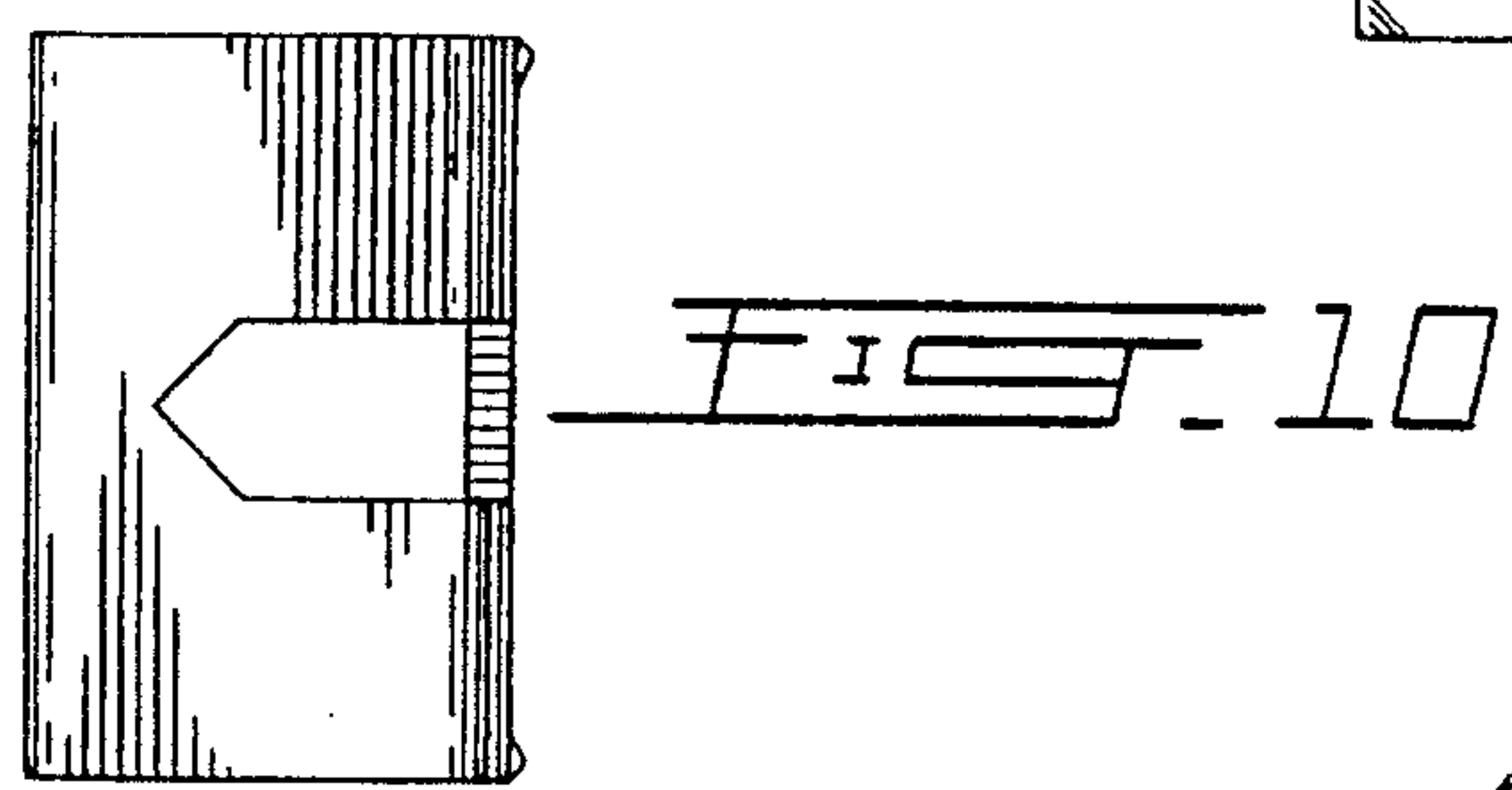
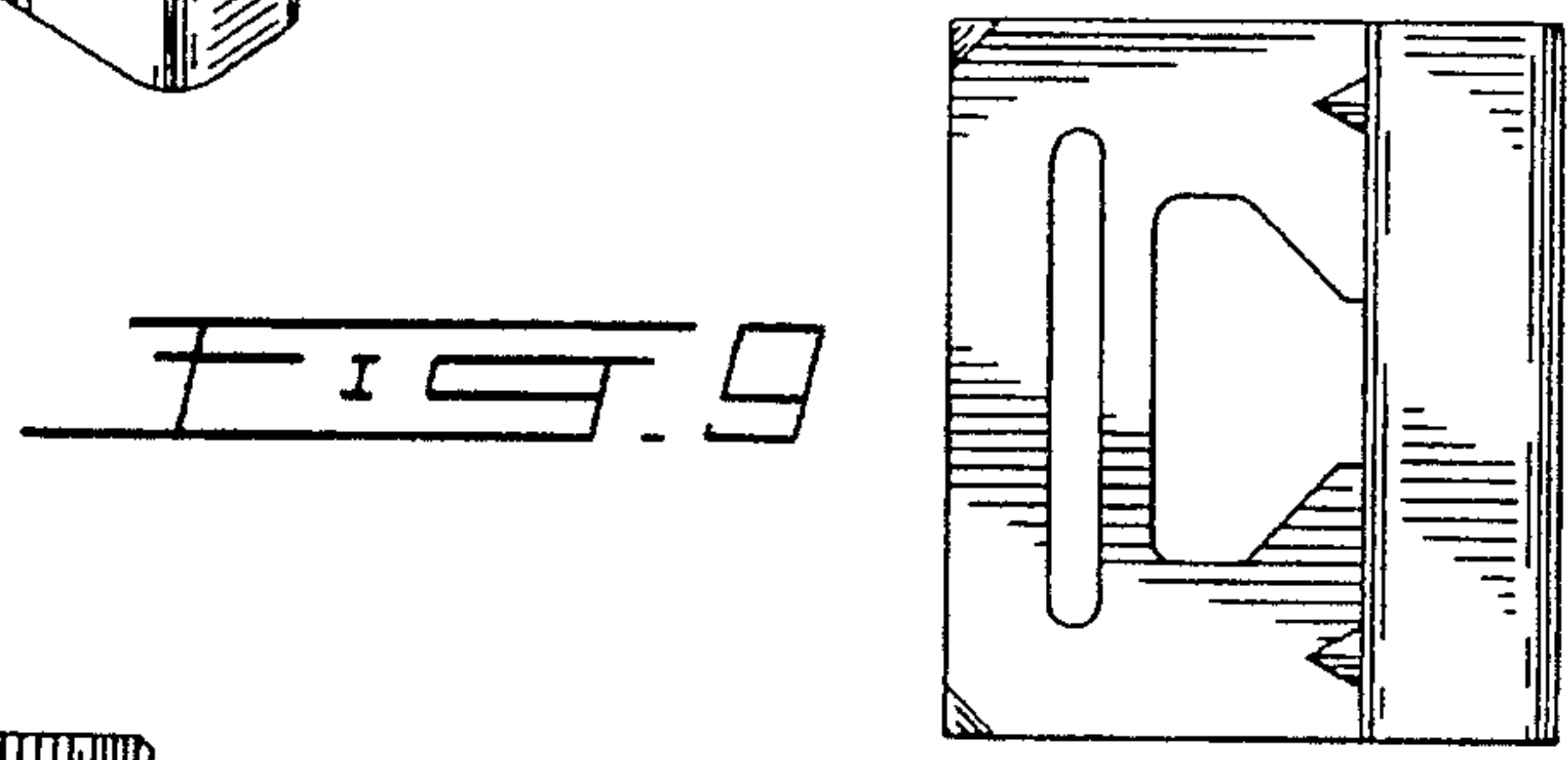
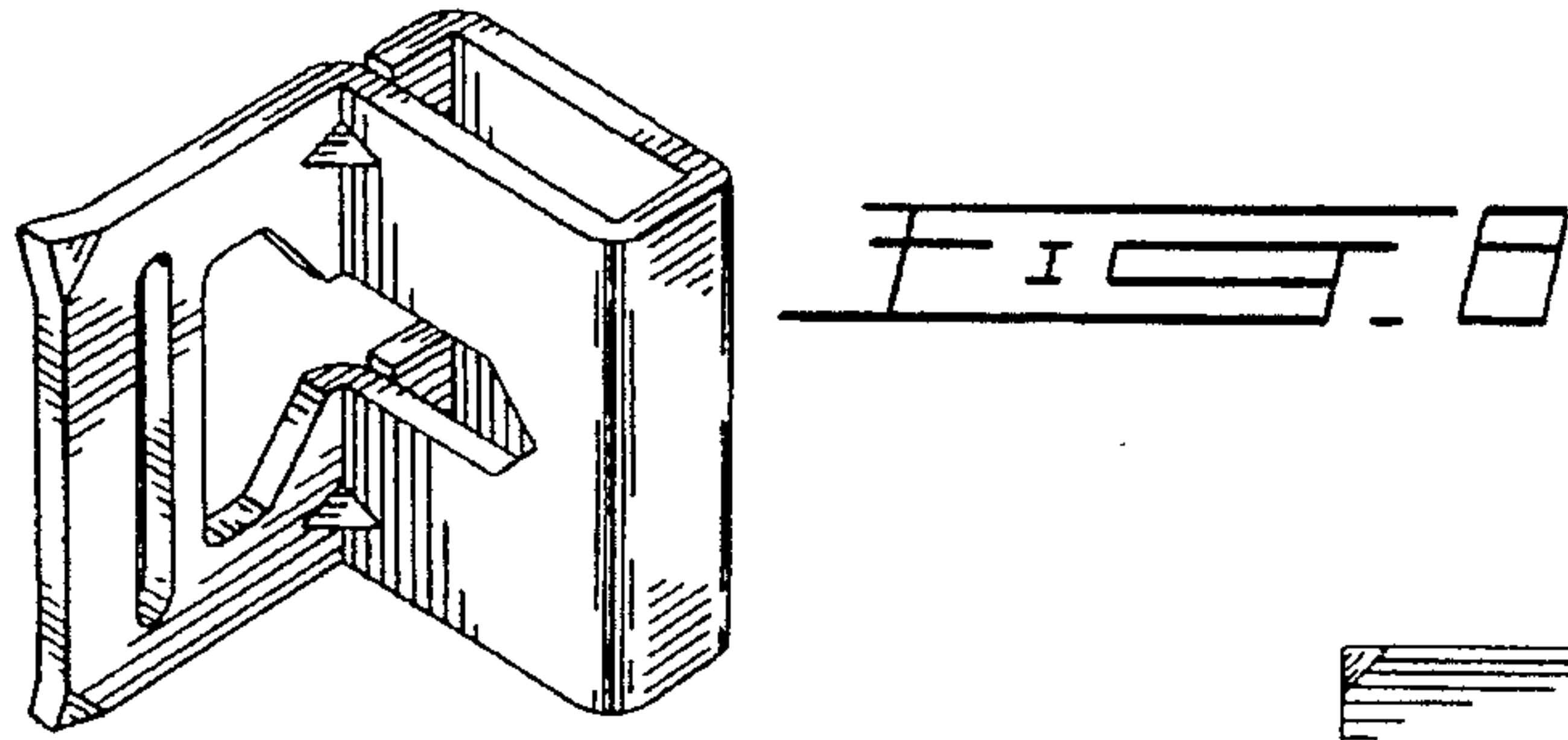

FIG. 7



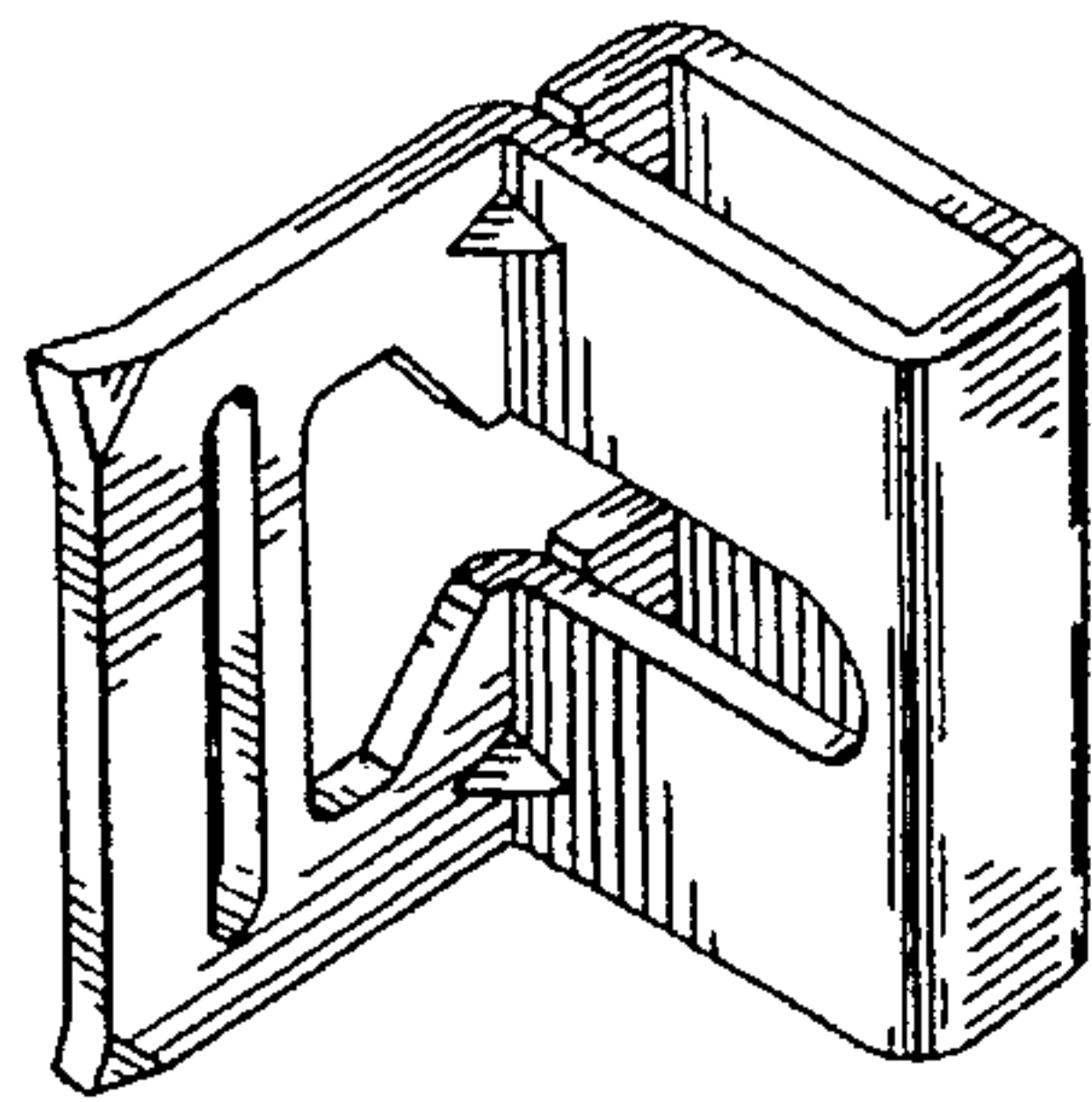

FIG. 15

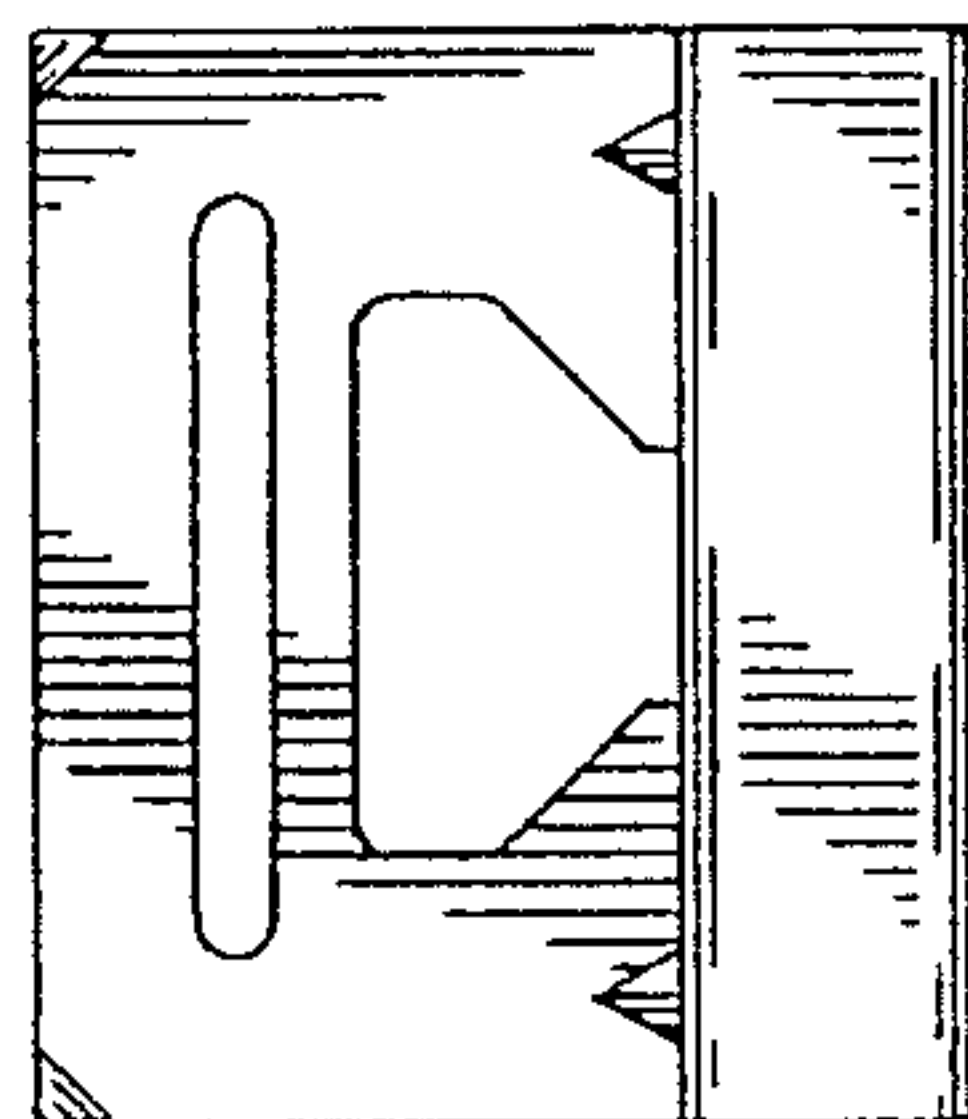

FIG. 16

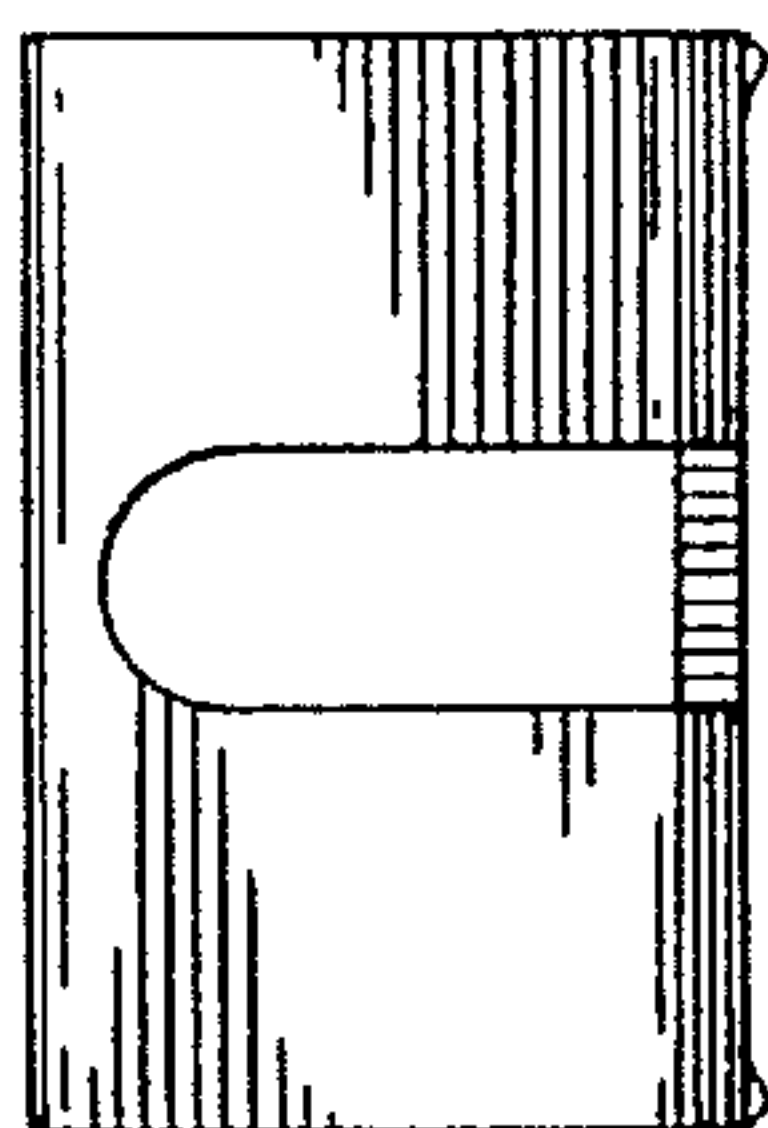

FIG. 17

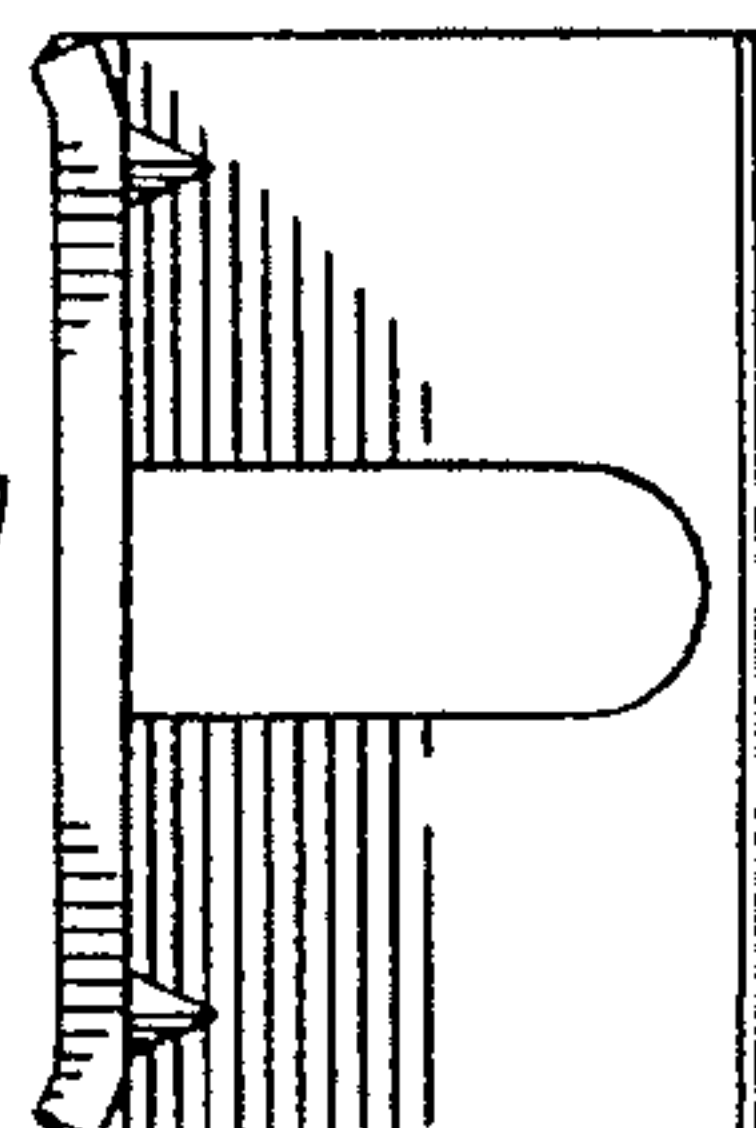

FIG. 18

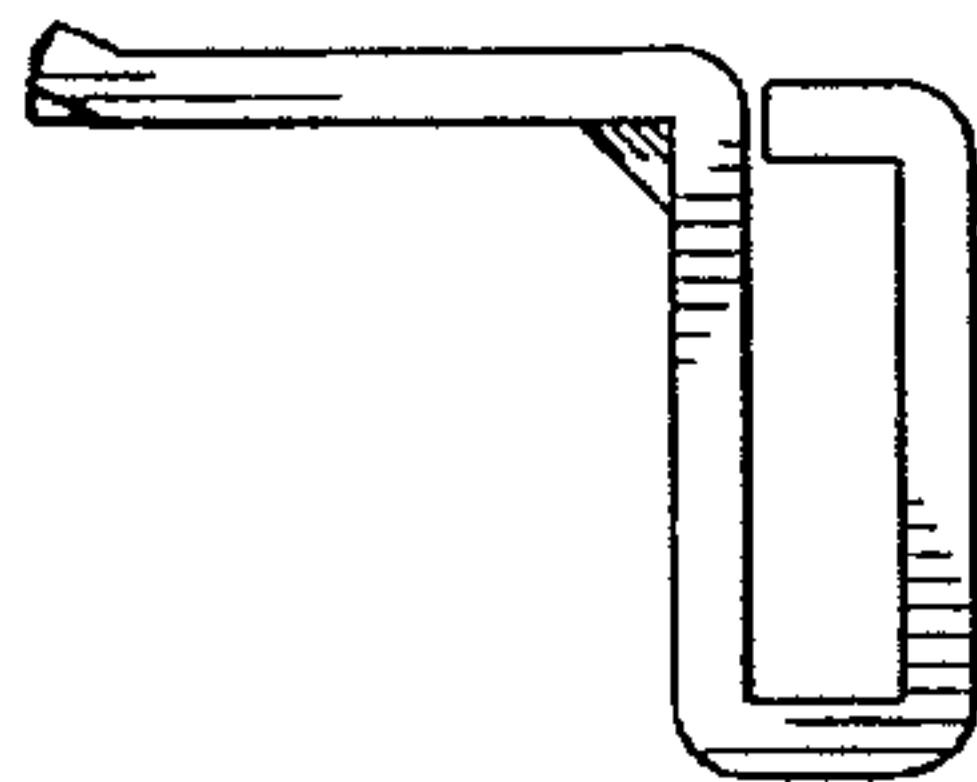

FIG. 19

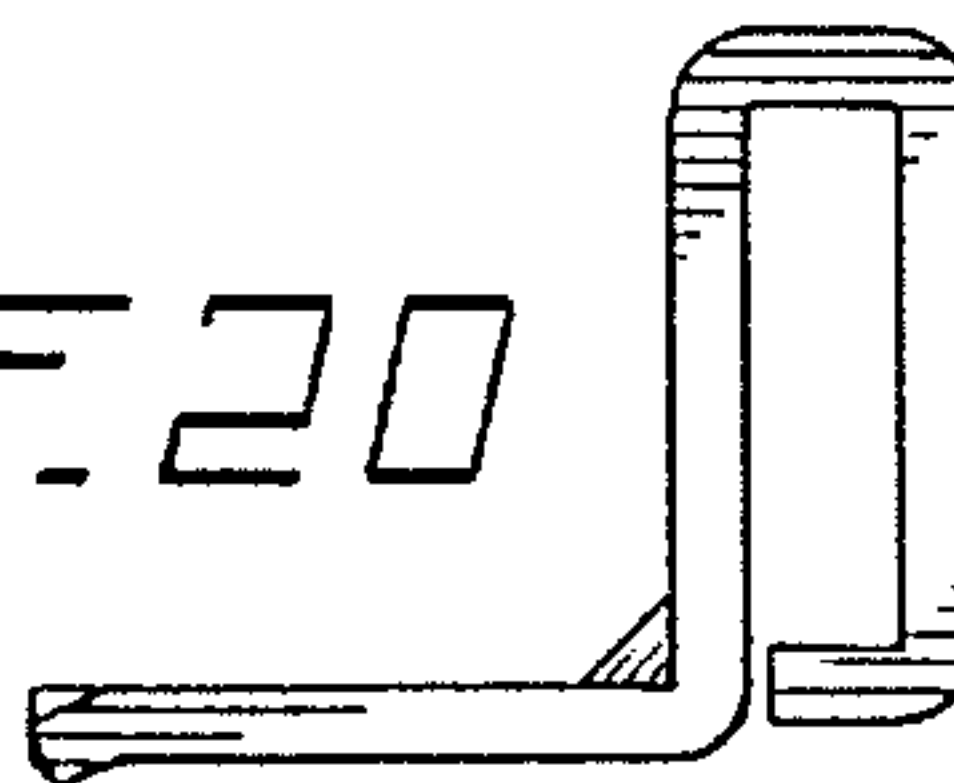

FIG. 20

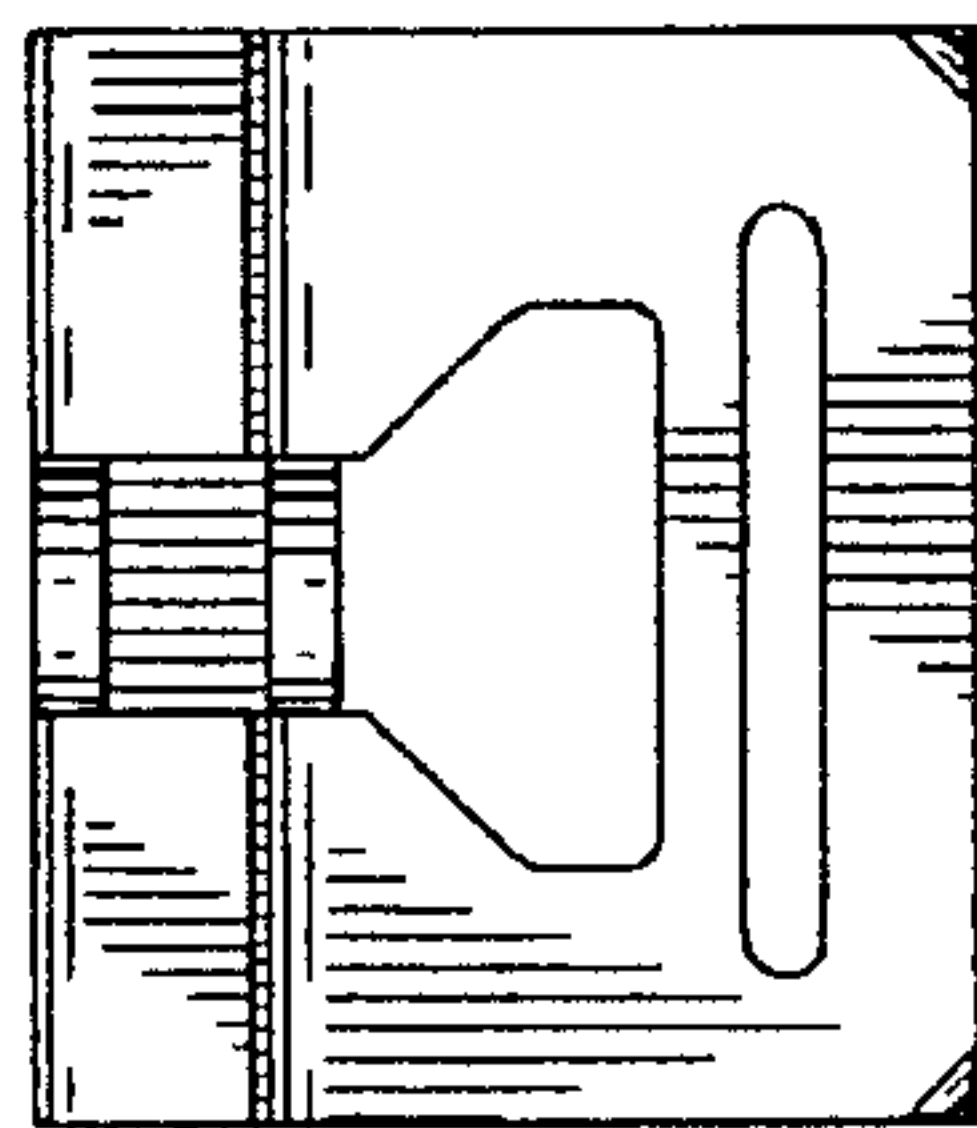

FIG. 21