



US00D378126S

United States Patent [19]

[11] **Patent Number: Des. 378,126**

Williams

[45] **Date of Patent: **Feb. 18, 1997**

[54] **AIR FRESHENER FOR MICROWAVE OVENS**

Primary Examiner—Lisa P. Lichtenstein

[76] **Inventor: Diana Williams**, 1009-B Charlotte,
Austin, Tex. 78703

Attorney, Agent, or Firm—Harold H. Dutton, Jr.; W. Charles
L. Jamison; Diane F. Liebman

[**] **Term: 14 Years**

[57] **CLAIM**

[21] **Appl. No.: 51,059**

The ornamental design for an air freshener for microwave
ovens, as shown.

[22] **Filed: Mar. 1, 1996**

DESCRIPTION

[52] **U.S. Cl. D23/366; D23/369**

[58] **Field of Search D23/366-369;**
239/55, 56; D9/414, 418, 420, 423, 426;
422/120, 305; 261/DIG. 65

FIG. 1 is a perspective view of an air freshener for micro-
wave ovens showing my new design;

FIG. 2 is a top view thereof;

FIG. 3 is a bottom view thereof;

FIG. 4 is a front view thereof;

FIG. 5 is a rear view thereof;

FIG. 6 is a right side view thereof; and,

FIG. 7 is a left side view thereof.

[56] **References Cited**

U.S. PATENT DOCUMENTS

D. 359,311	6/1995	Stangarone	D20/10
1,742,962	1/1930	McCrosky	239/55
4,960,240	10/1990	McElfresh	239/56

1 Claim, 5 Drawing Sheets

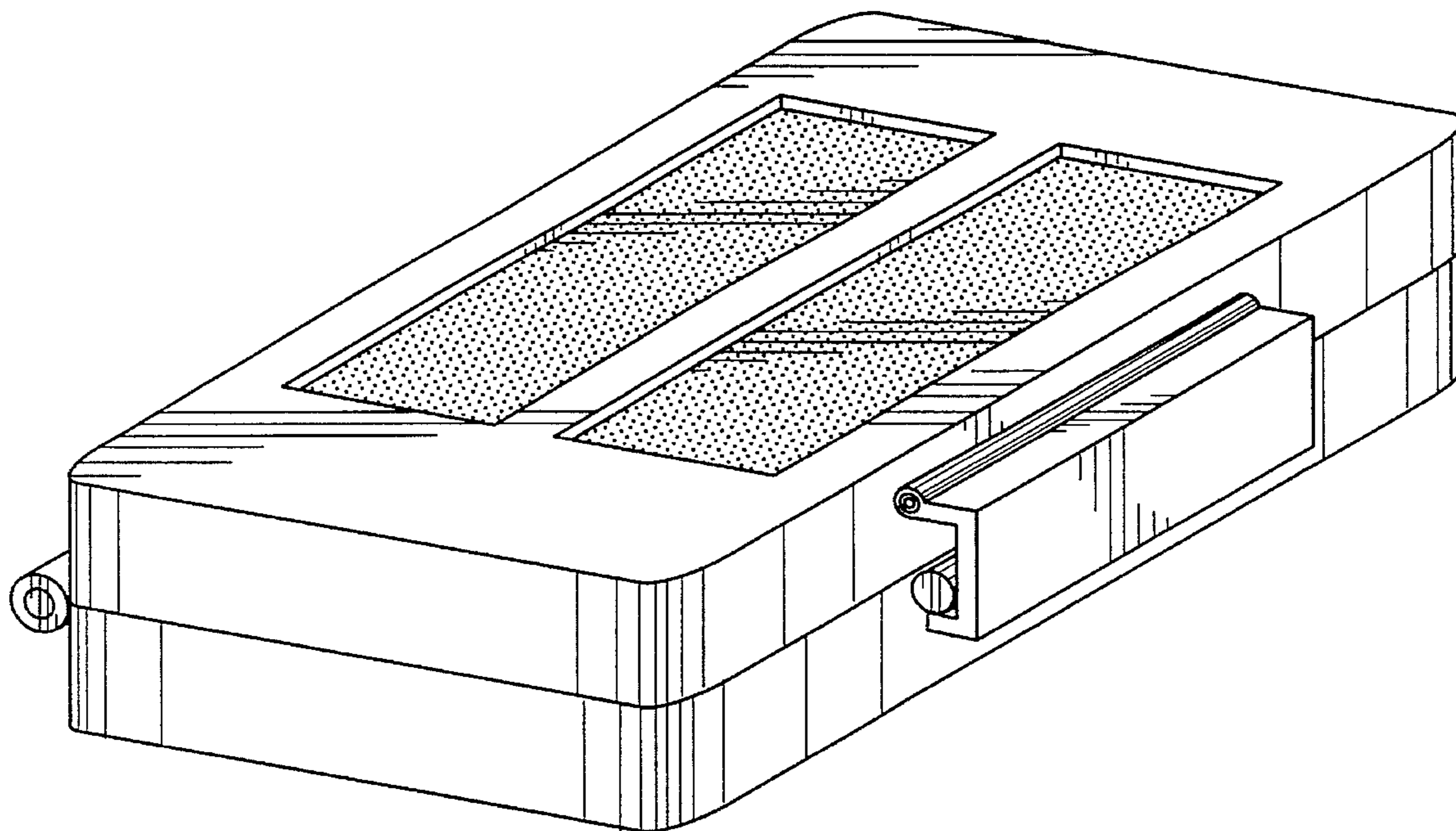

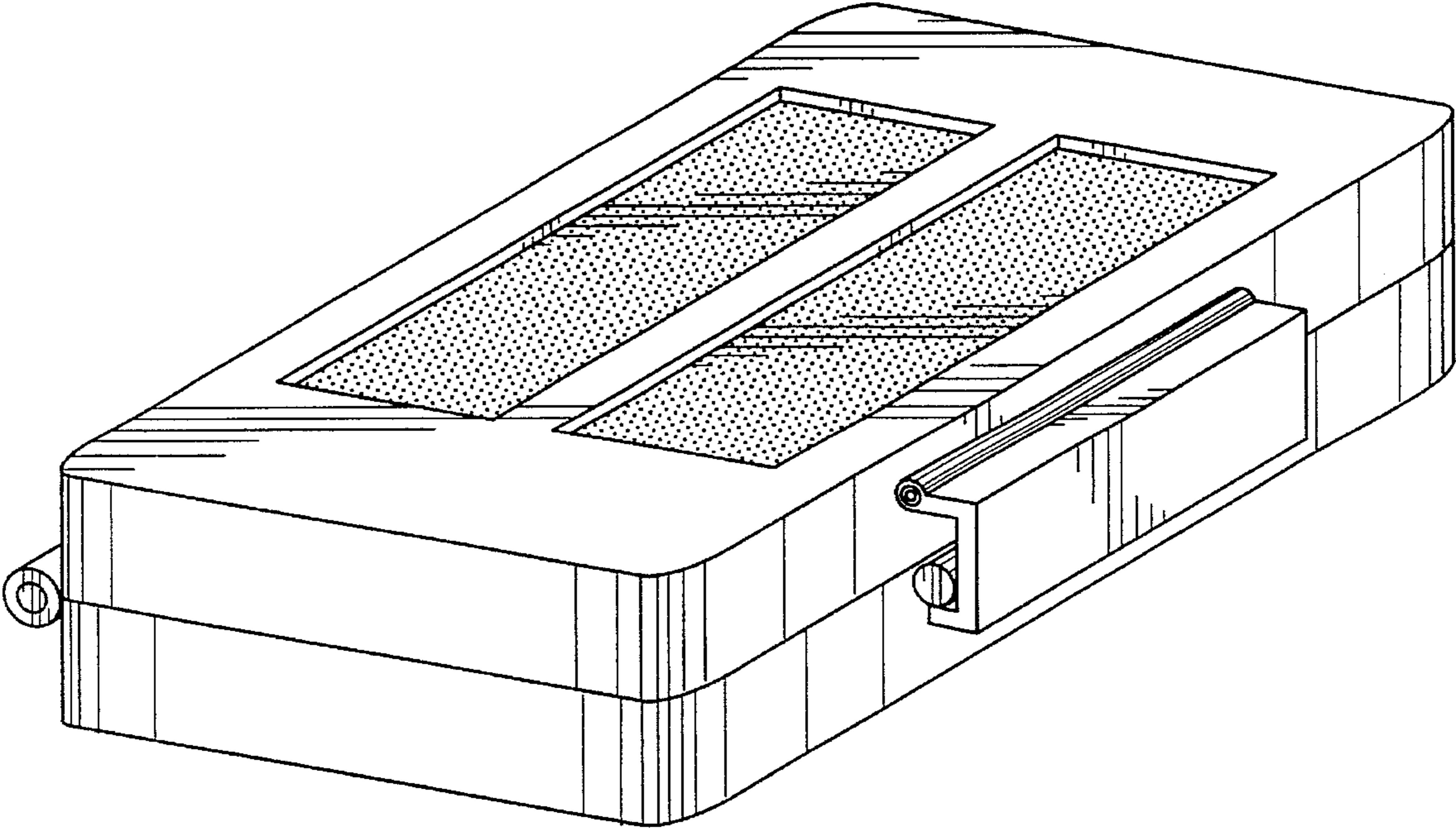

FIG. 1

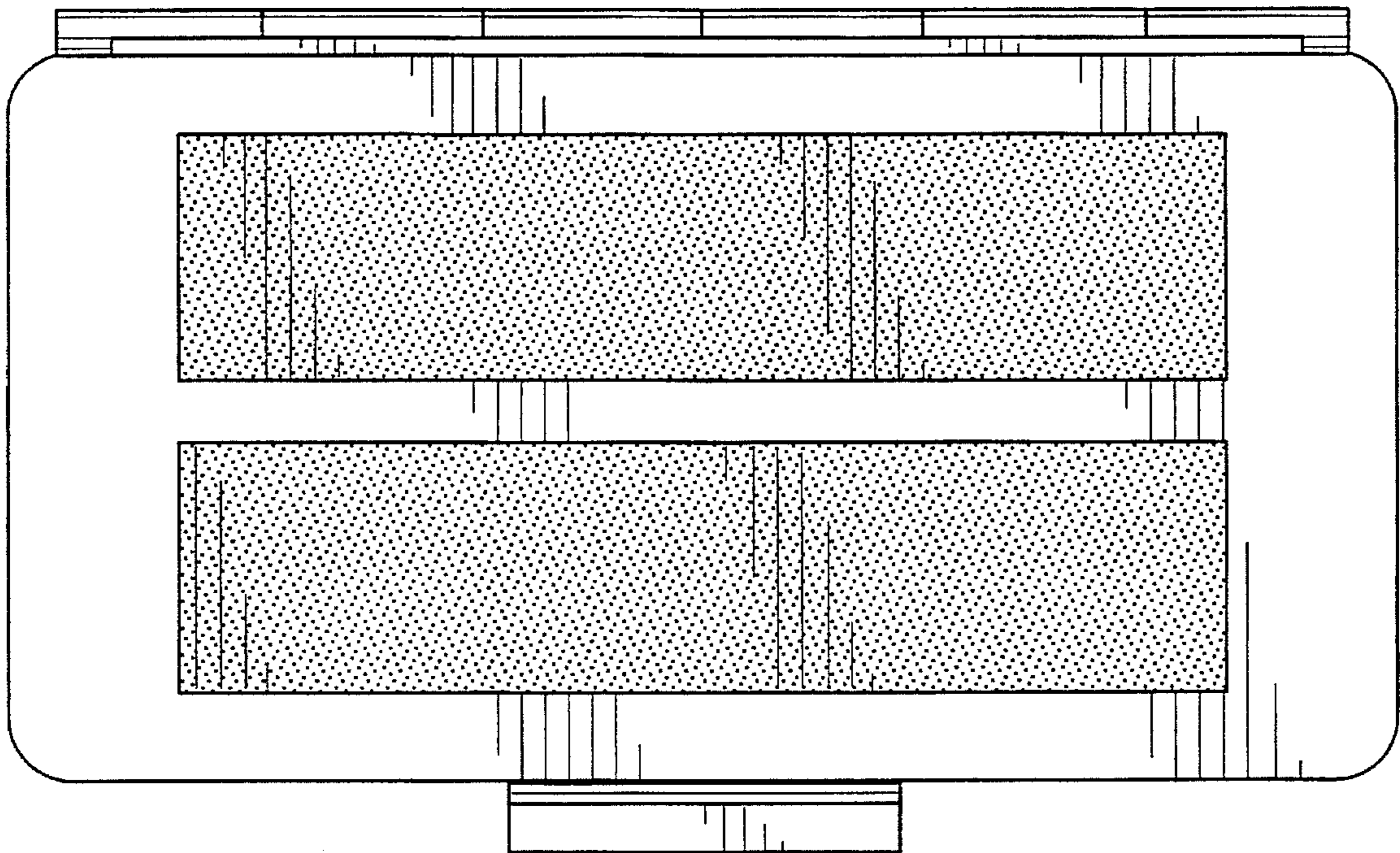

FIG. 2

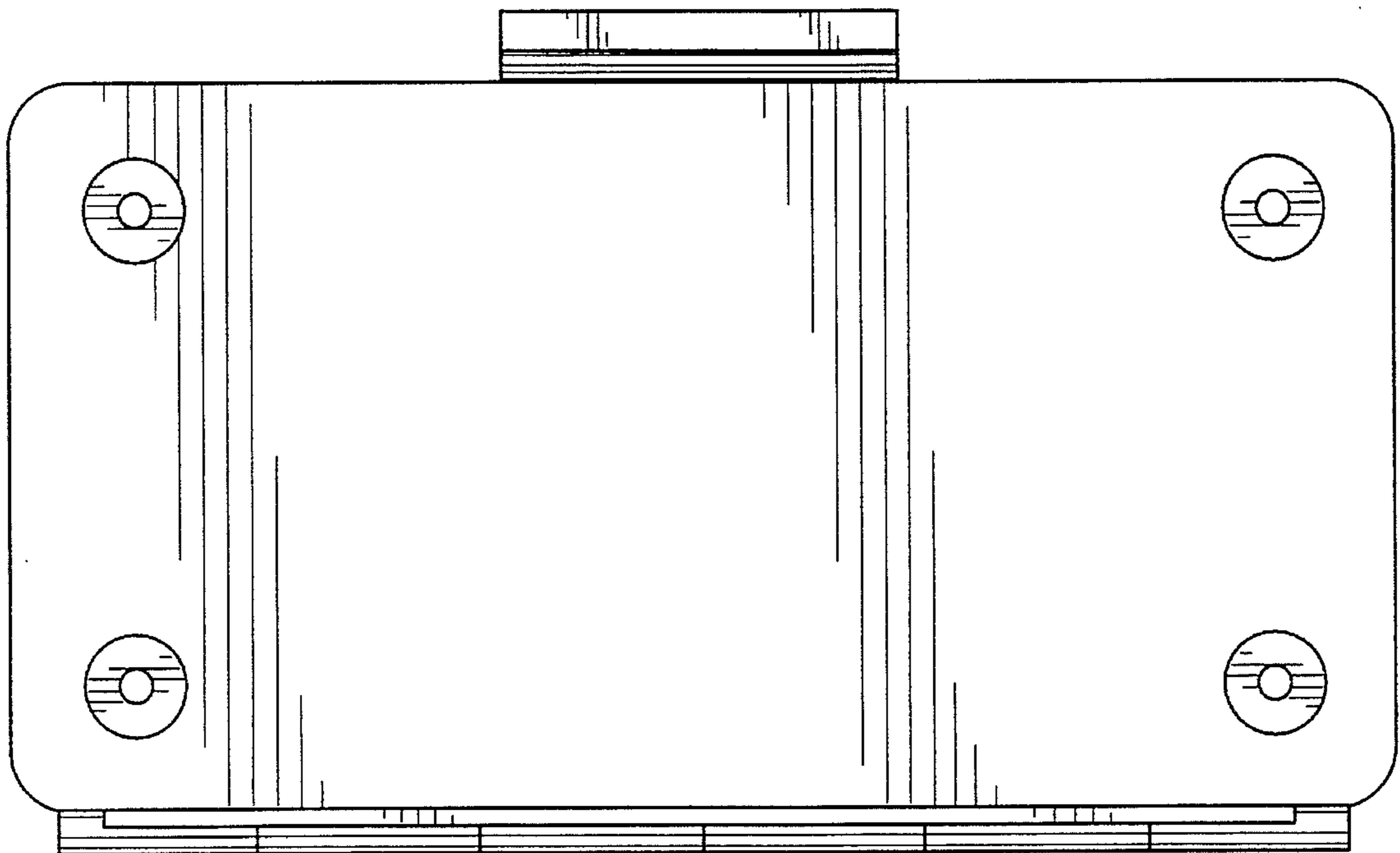

FIG. 3

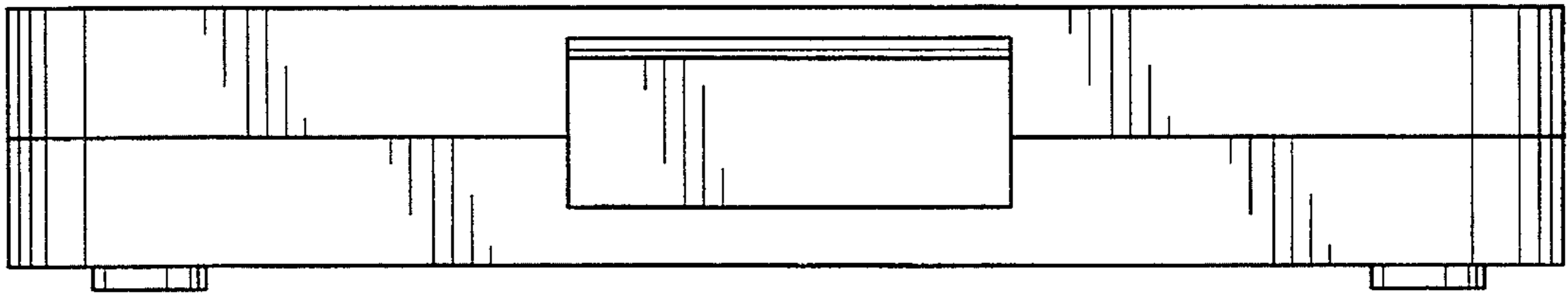

FIG. 4

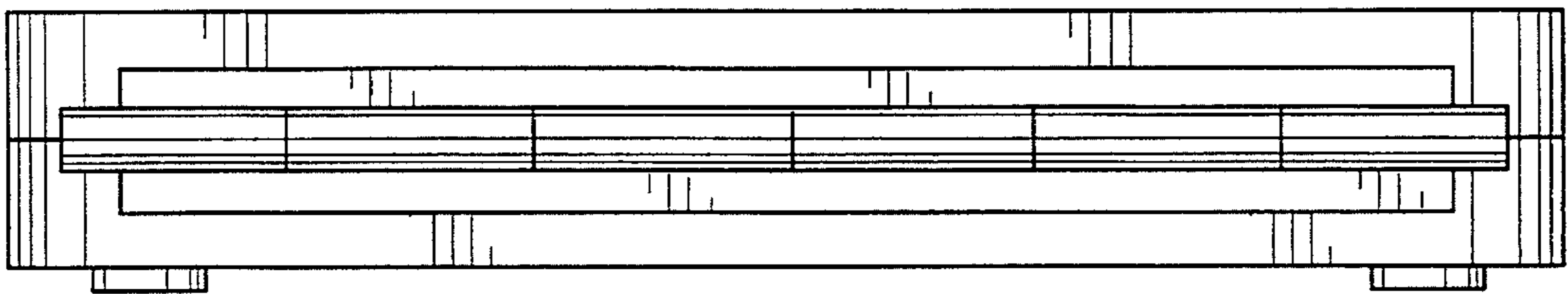

FIG. 5

FIG. 6

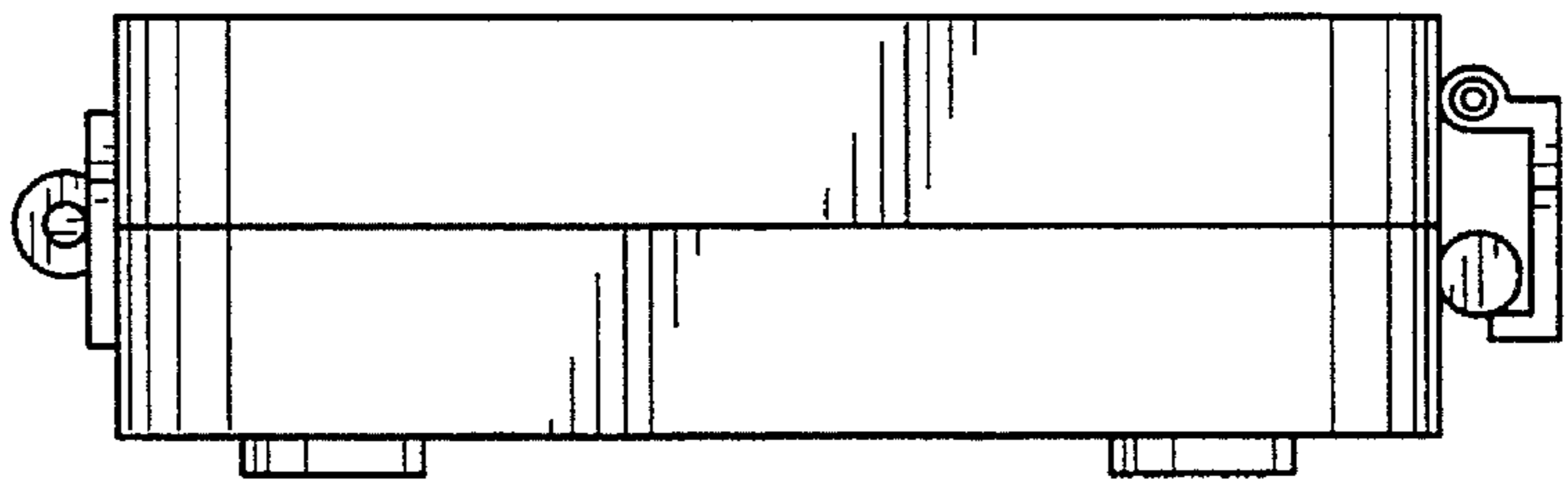
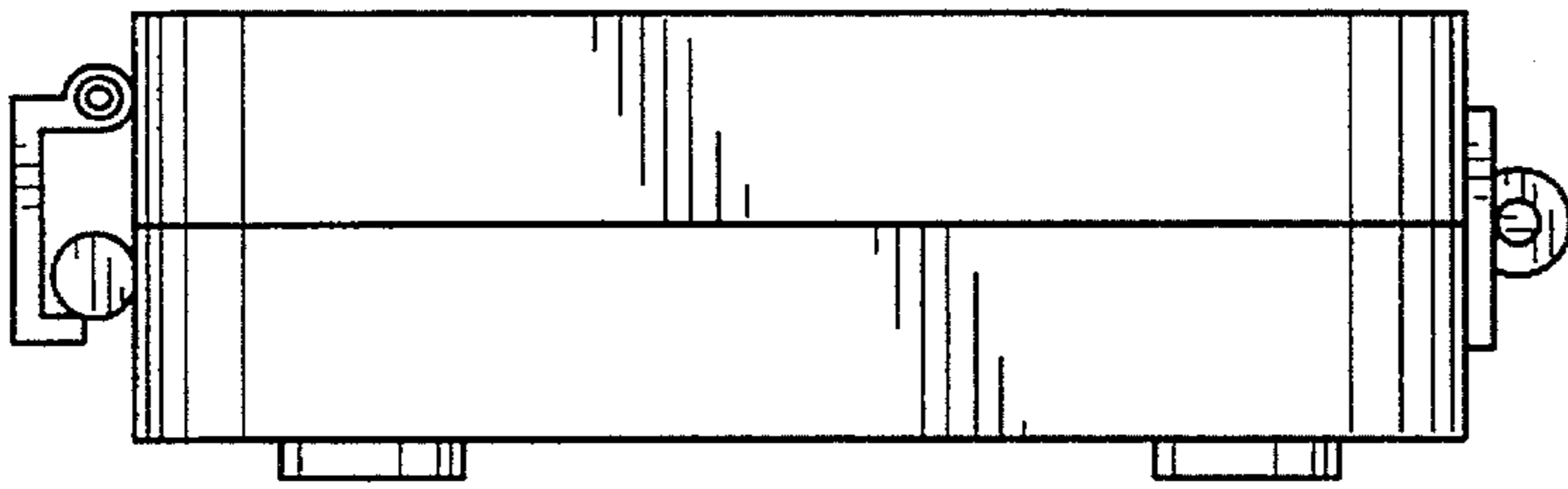

FIG. 7