



US00D378099S

# United States Patent [19]

[11] Patent Number: **Des. 378,099**

Yoshida et al.

[45] Date of Patent: **\*\*Feb. 18, 1997**

[54] **COPIER**

[75] Inventors: **Kenzo Yoshida**, Nara-ken; **Kenji Ohta**, Osaka-fu; **Akira Tanabe**, Nara-ken, all of Japan

[73] Assignee: **Sharp Kabushiki Kaisha**, Osaka, Japan

[\*\*] Term: **14 Years**

[21] Appl. No.: **52,339**

[22] Filed: **Mar. 27, 1996**

### [30] Foreign Application Priority Data

Sep. 27, 1995 [JP] Japan ..... 7-28851

[52] U.S. Cl. .... **D18/36**

[58] Field of Search ..... D18/36-39, 54; D14/111, 112, 116, 118; 355/200, 210, 231, 233-236, 245, 260, 326-328

### [56] References Cited

#### U.S. PATENT DOCUMENTS

- D. 278,152 3/1985 Hara et al. .... D18/36
- D. 286,785 11/1986 Okuyama et al. .... D18/36

- D. 297,436 8/1988 Okuyama et al. .... D18/36
- D. 313,038 12/1990 Hara et al. .... D18/36
- D. 334,205 3/1993 Ratzlaff ..... D18/39
- D. 339,151 9/1993 Ratzlaff ..... D18/36
- D. 339,152 9/1993 Hirose et al. .... D18/39
- D. 354,076 1/1995 Fukuda et al. .... D18/36
- D. 362,675 9/1995 Umeda et al. .... D18/36 X

*Primary Examiner*—James Gandy  
*Assistant Examiner*—Caron D. Veynar  
*Attorney, Agent, or Firm*—Nixon & Vanderhye

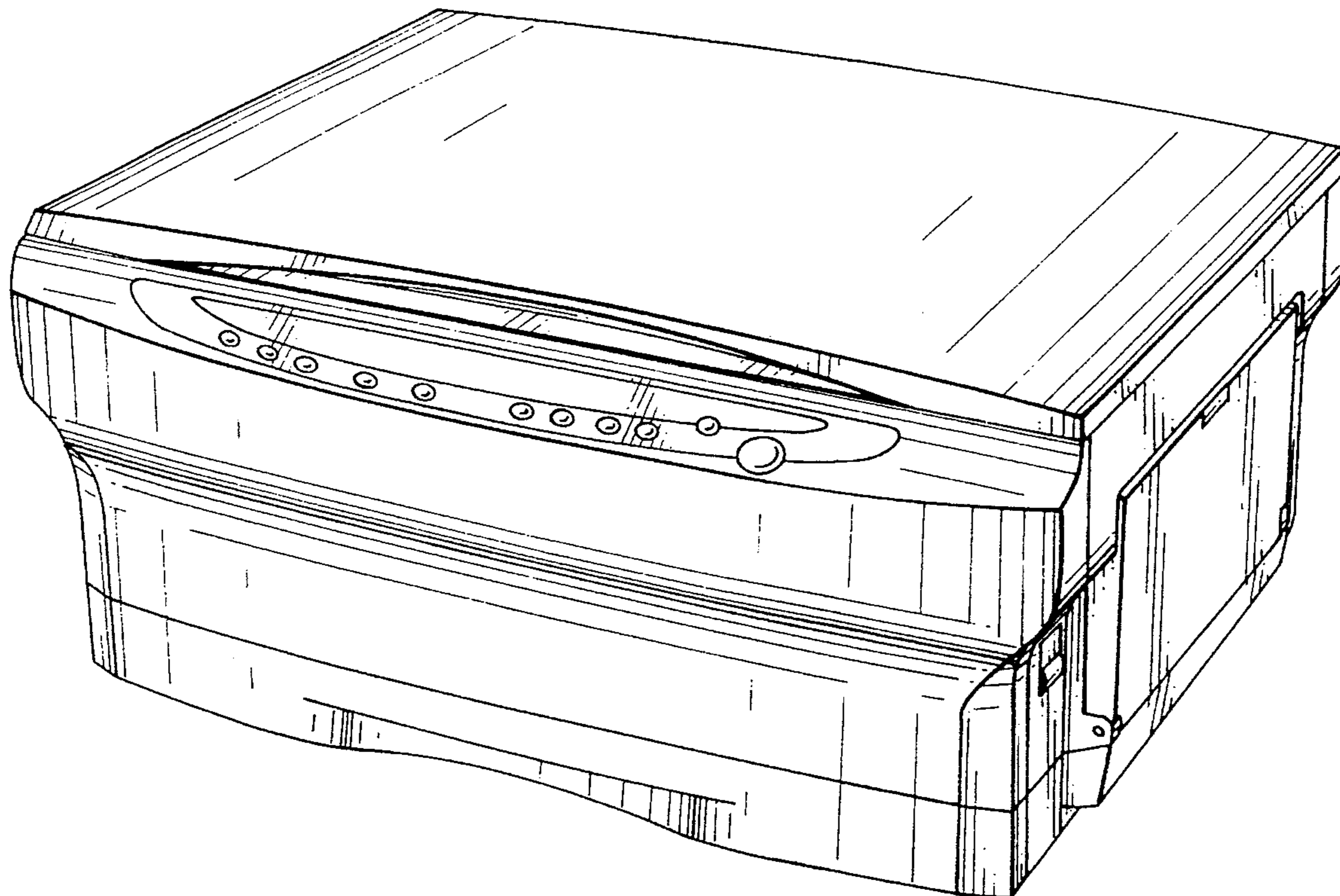
### [57] CLAIM

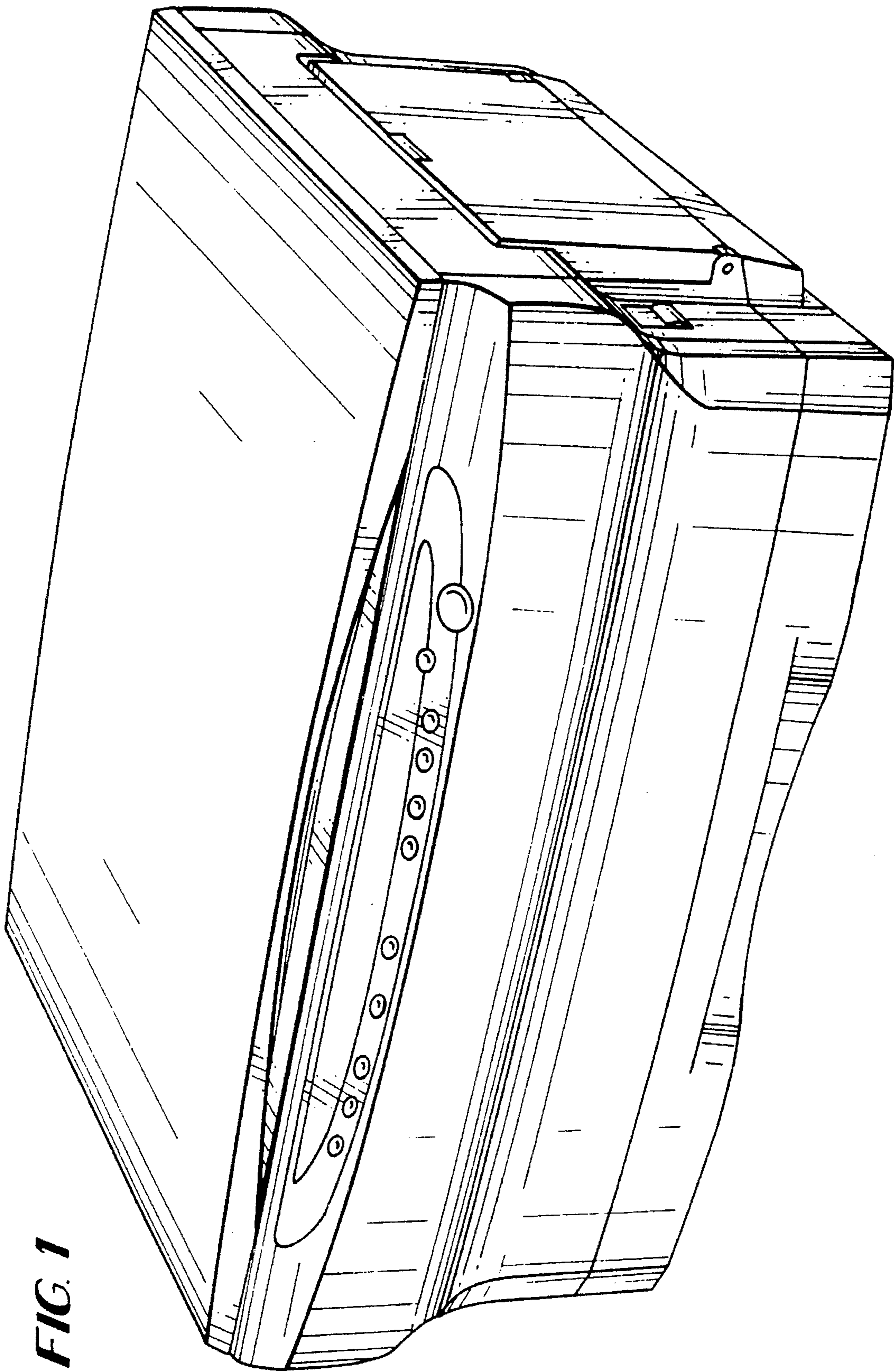
The ornamental design for a copier, as shown and described.

### DESCRIPTION

FIG. 1 is a top, front and right side perspective view of a copier according to our design;  
FIG. 2 is a top plan view thereof;  
FIG. 3 is a front elevational view thereof;  
FIG. 4 is a right side elevational view thereof;  
FIG. 5 is a rear elevational view thereof;  
FIG. 6 is a left side elevational view thereof; and,  
FIG. 7 is a bottom plan view thereof.

**1 Claim, 5 Drawing Sheets**





**FIG. 1**

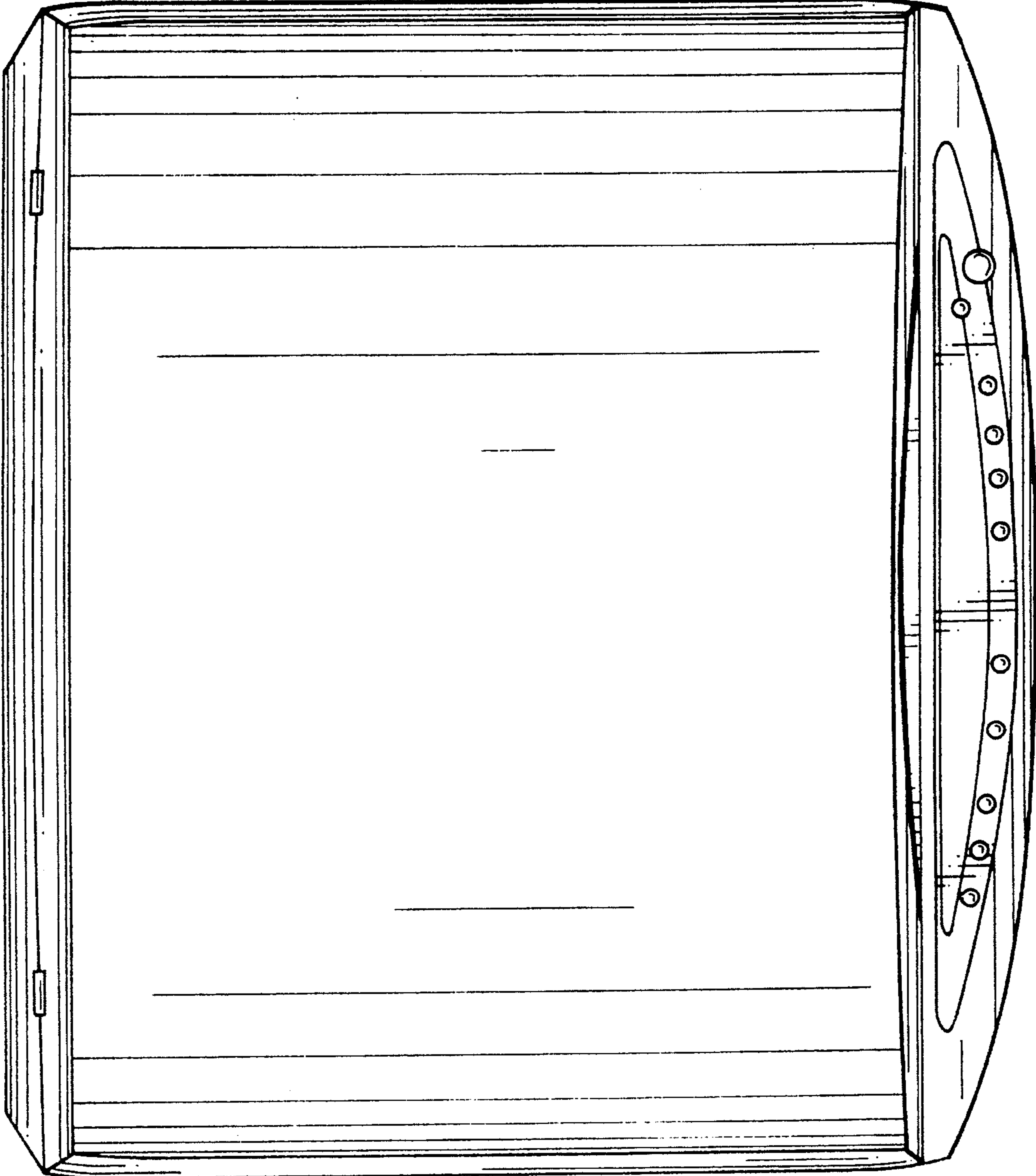
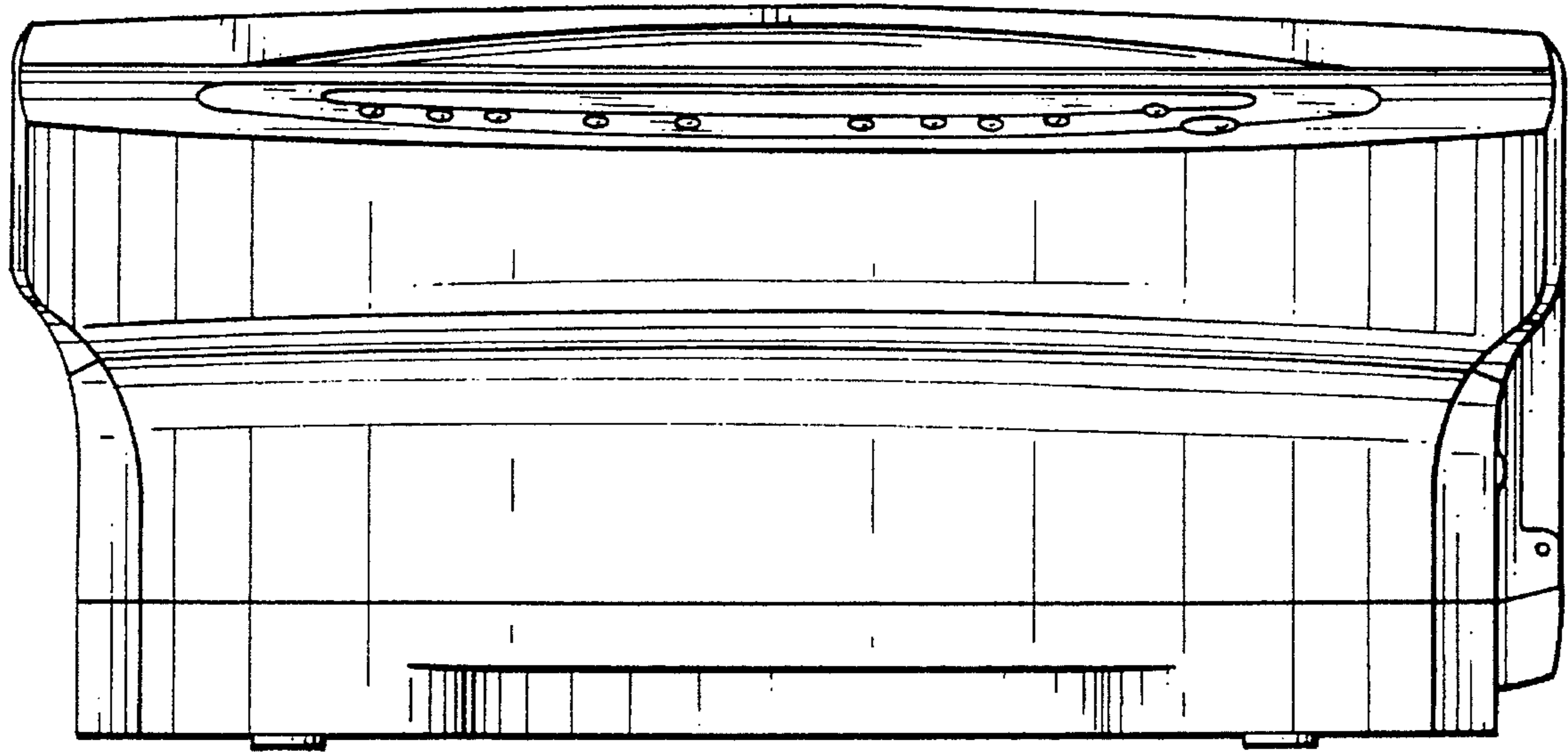
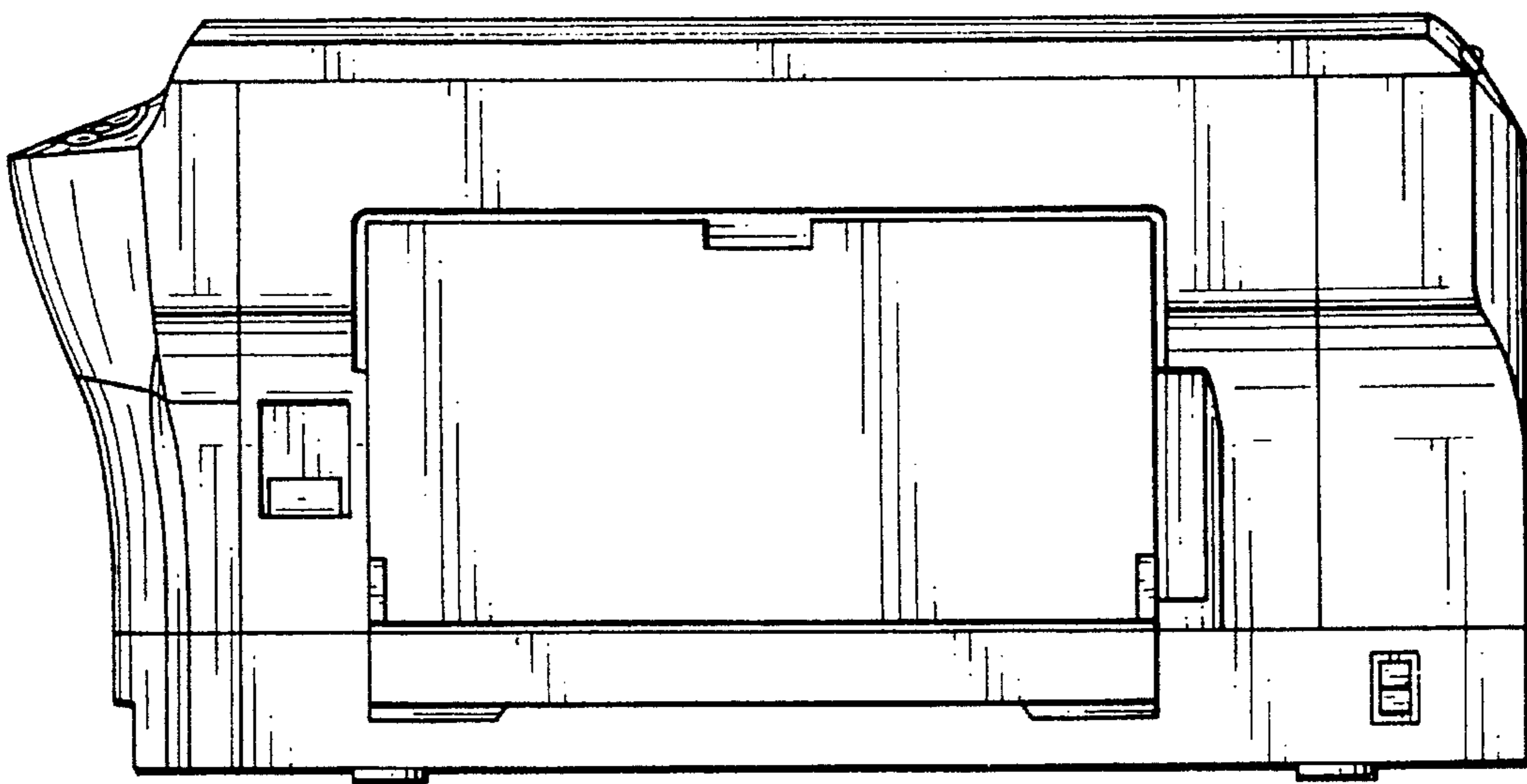


FIG. 2

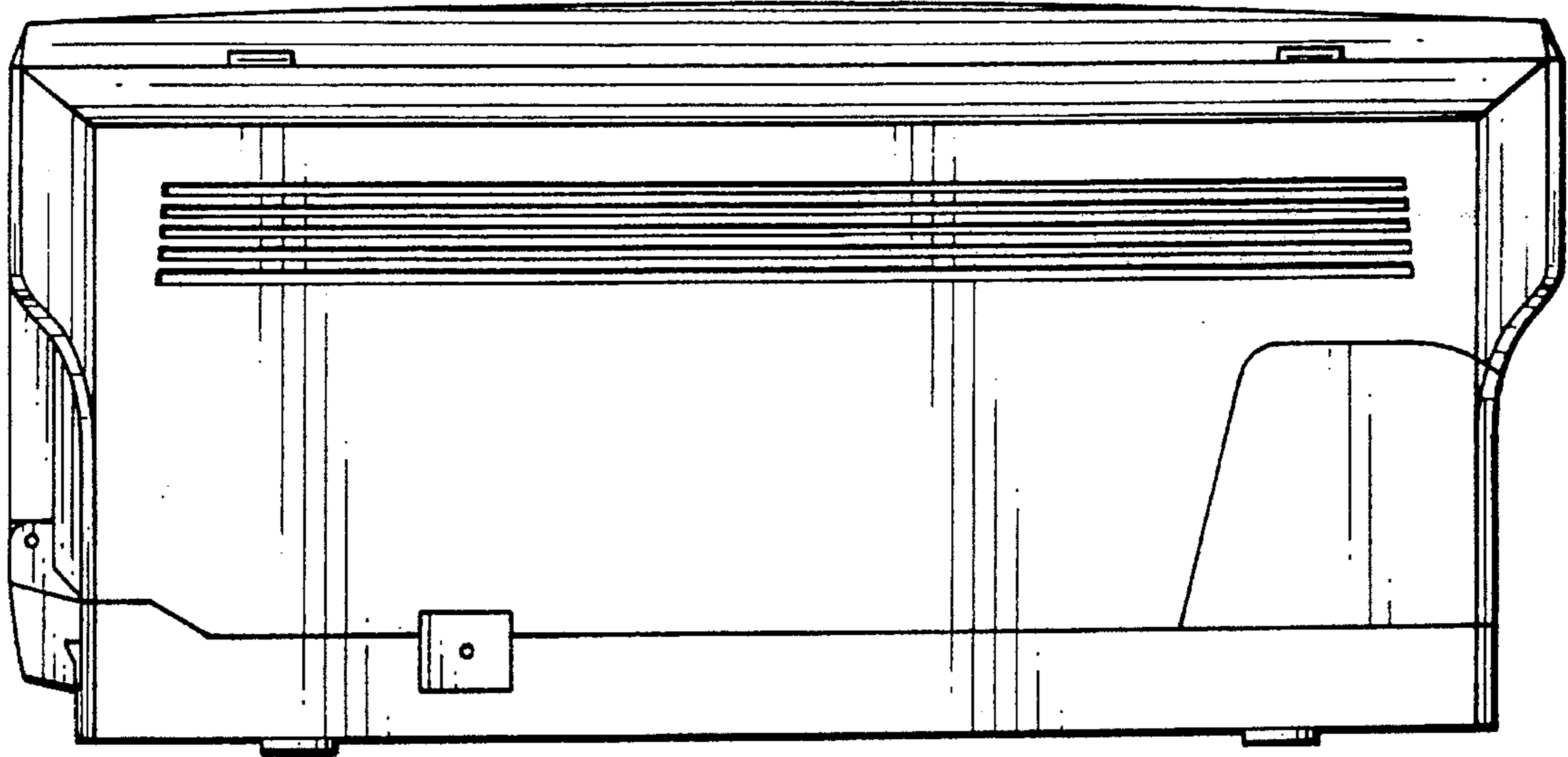
*FIG. 3*



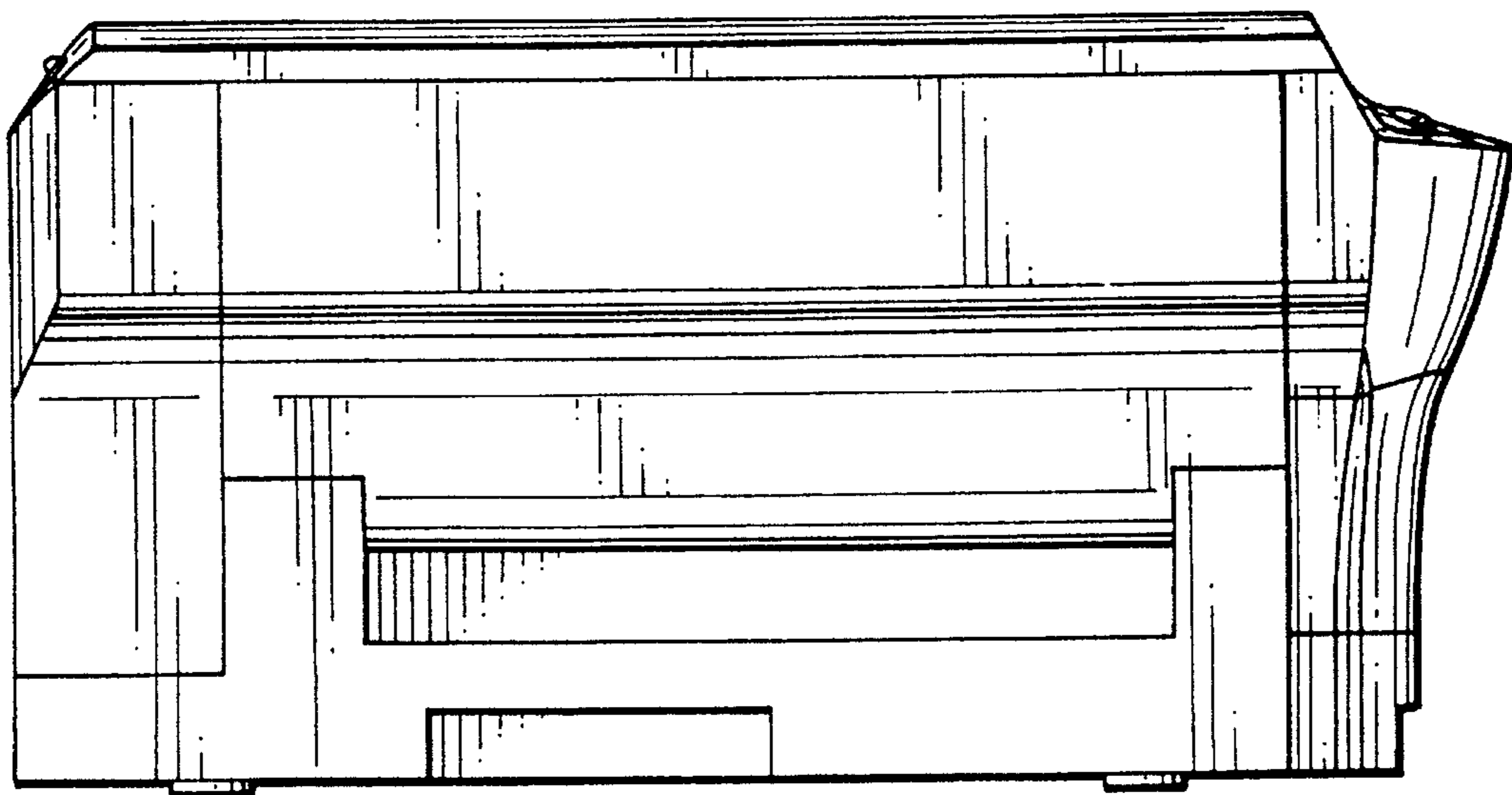
*FIG. 4*

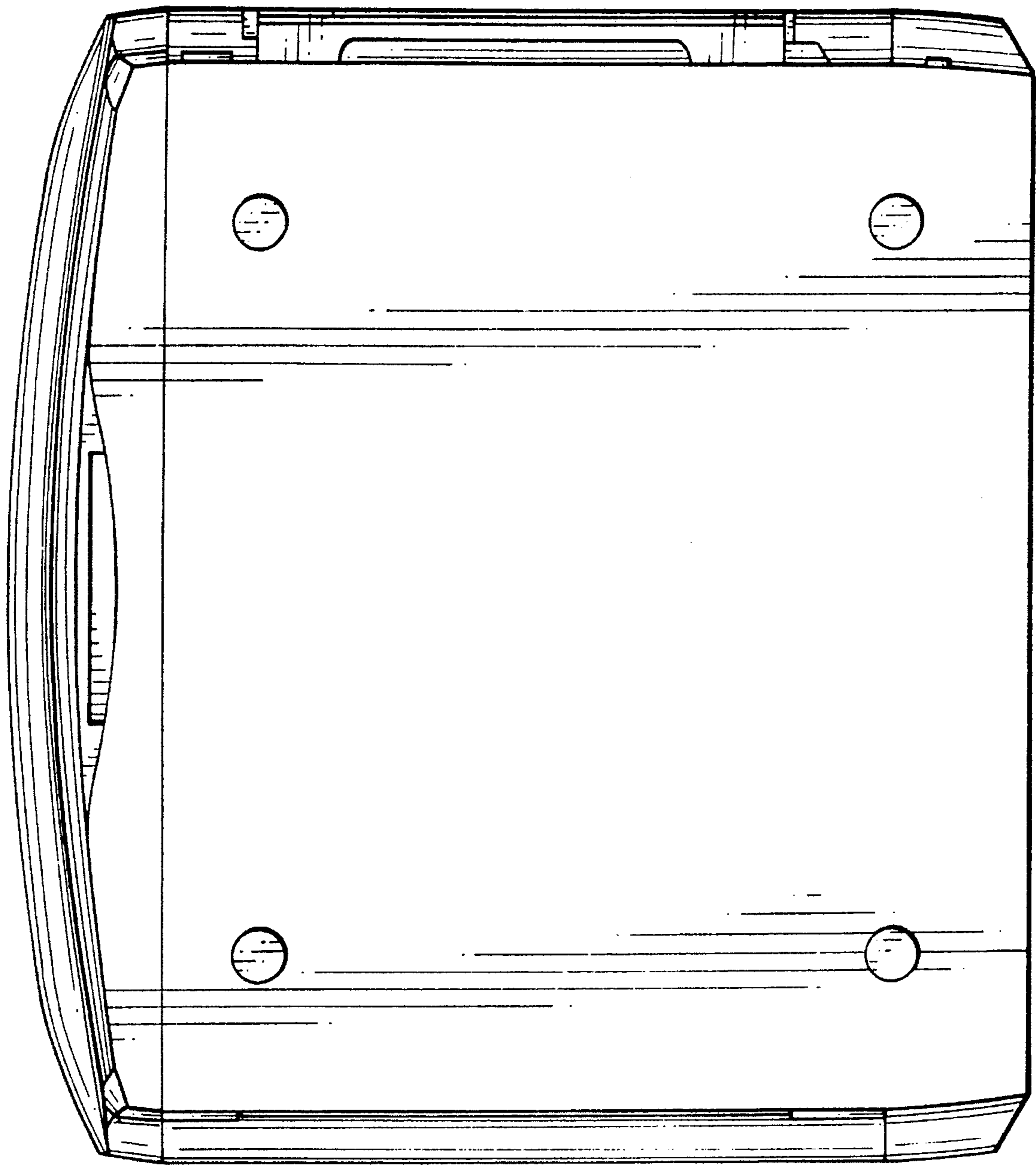


*FIG. 5*



*FIG. 6*





**FIG. 7**