



US00D378095S

# United States Patent [19]

Hasegawa

[11] Patent Number: **Des. 378,095**

[45] Date of Patent: **\*\*Feb. 18, 1997**

[54] **SURVEILLANCE CAMERA**

[75] Inventor: **Fumio Hasegawa**, Nagoya, Japan

[73] Assignee: **Elmo Company Limited**, Japan

[\*\*] Term: **14 Years**

[21] Appl. No.: **49,162**

[22] Filed: **Jan. 18, 1996**

### Related U.S. Application Data

[63] Continuation of Ser. No. 36,583, Mar. 23, 1995, abandoned.

### [30] Foreign Application Priority Data

Sep. 26, 1994 [JP] Japan ..... 6-29204

[52] U.S. Cl. .... **D16/203**

[58] Field of Search ..... D16/200-204,  
D16/221; 348/143, 373-376; 354/63, 64

### [56] References Cited

#### U.S. PATENT DOCUMENTS

D. 216,839	3/1970	Rhoades	.....	D16/221
D. 307,915	5/1990	Kuestner, III	.....	D16/203
D. 349,714	8/1994	Hasegawa	.....	D16/203
D. 349,911	8/1994	Shimizu et al.	.....	D16/203
4,281,343	7/1981	Monteiro	.....	354/64
5,287,133	2/1994	Bohley	.....	354/63

### FOREIGN PATENT DOCUMENTS

797243 12/1988 Japan .

### OTHER PUBLICATIONS

Catalog Page Cited In Corresponding Non-USA Application (Admitted Prior Art) (Surveillance Cameras) (copy in the file).

*Primary Examiner*—Terry A. Wallace

*Assistant Examiner*—Adir Aronovich

*Attorney, Agent, or Firm*—Ostrolenk, Faber, Gerb & Soffen, LLP

### [57] CLAIM

The ornamental design for a surveillance camera, as shown.

### DESCRIPTION

FIG. 1 is a front view of the surveillance camera embodying my new design;

FIG. 2 is a rear view thereof;

FIG. 3 is a top plan view thereof;

FIG. 4 is a bottom plan view thereof;

FIG. 5 is a left side view thereof;

FIG. 6 is a right side view thereof;

FIG. 7 is a perspective view as seen from the top and front of present FIG. 1; and,

FIG. 8 is a perspective view as seen from the top and front of present FIG. 6.

**1 Claim, 8 Drawing Sheets**

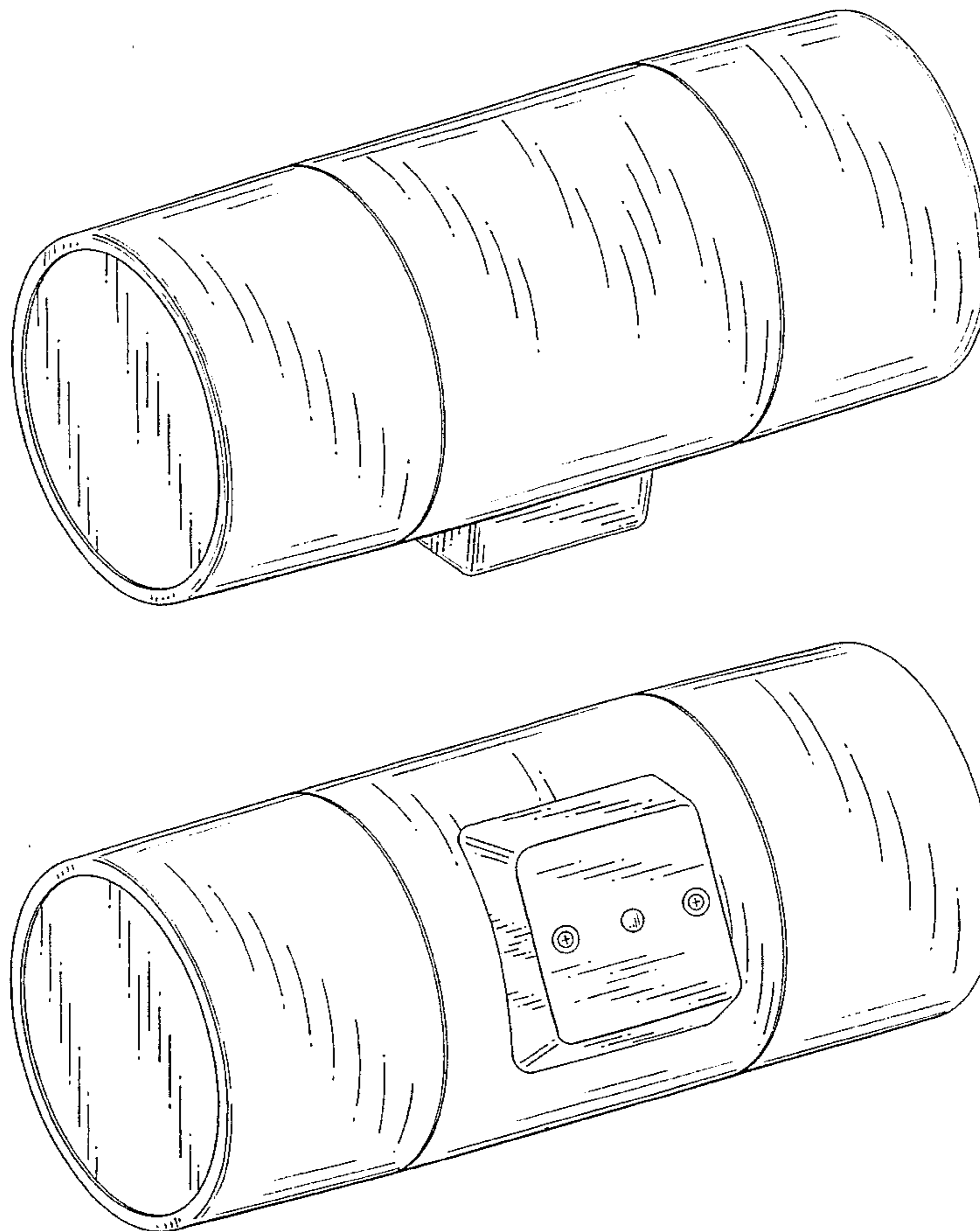

Fig. 1

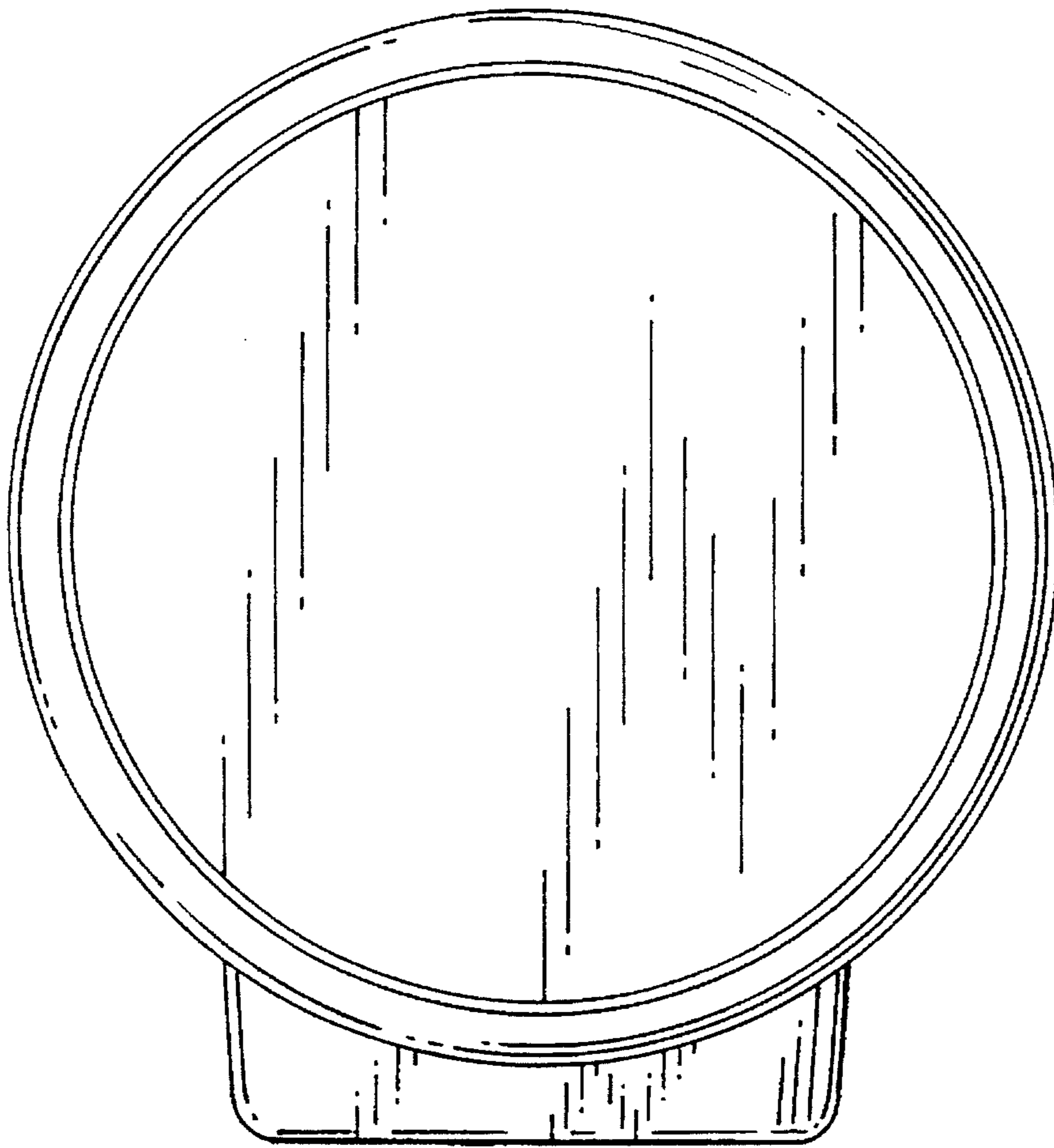

Fig. 2

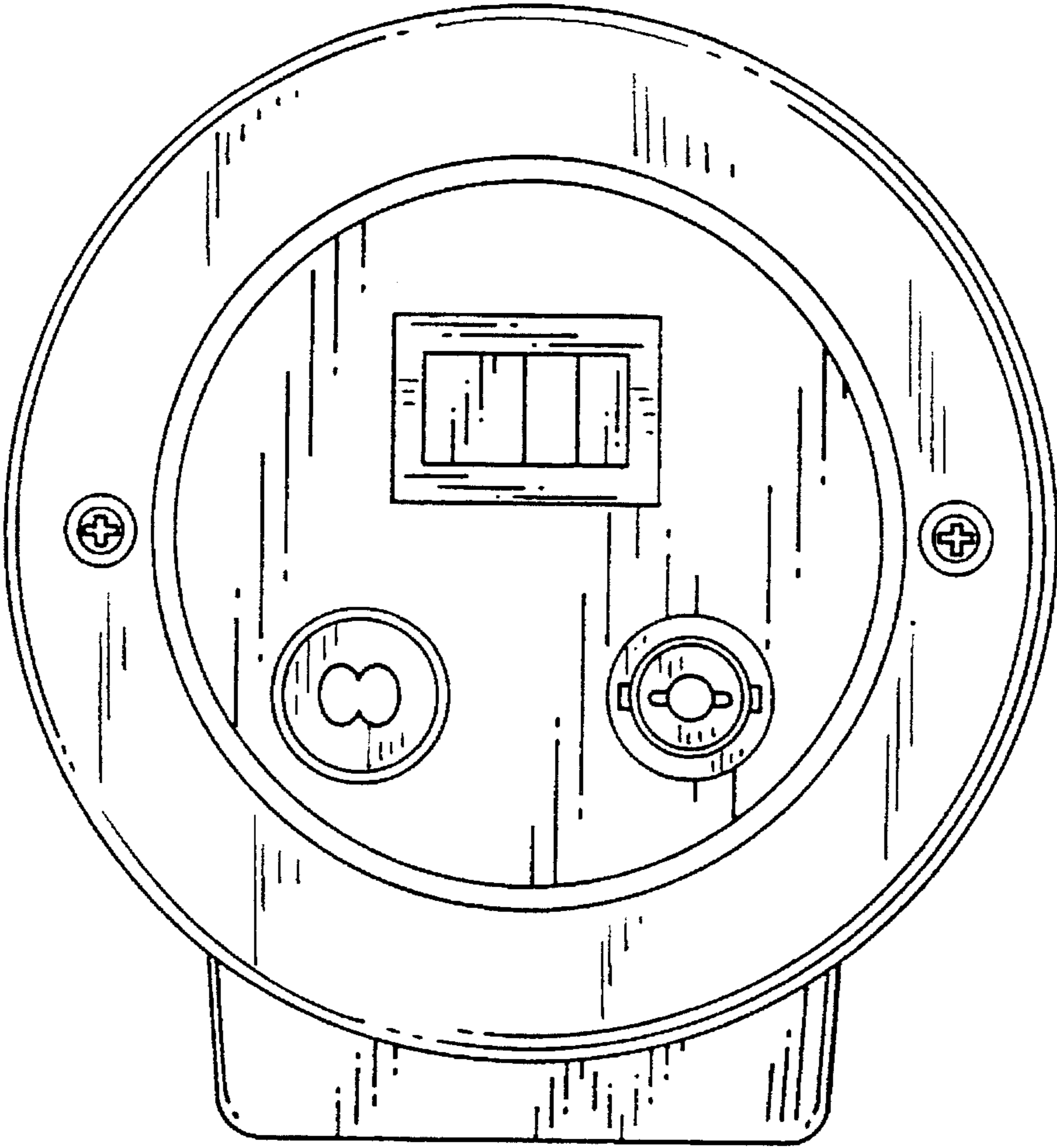

Fig. 3

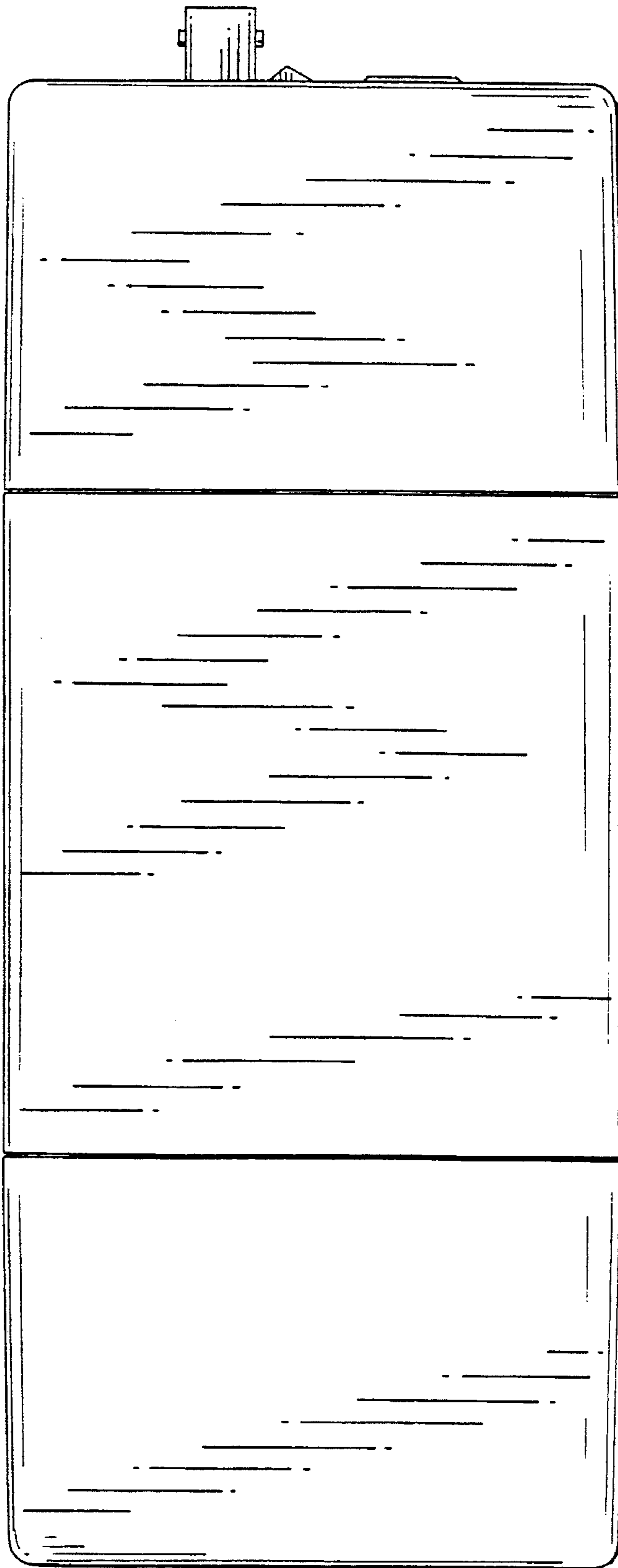

Fig. 4

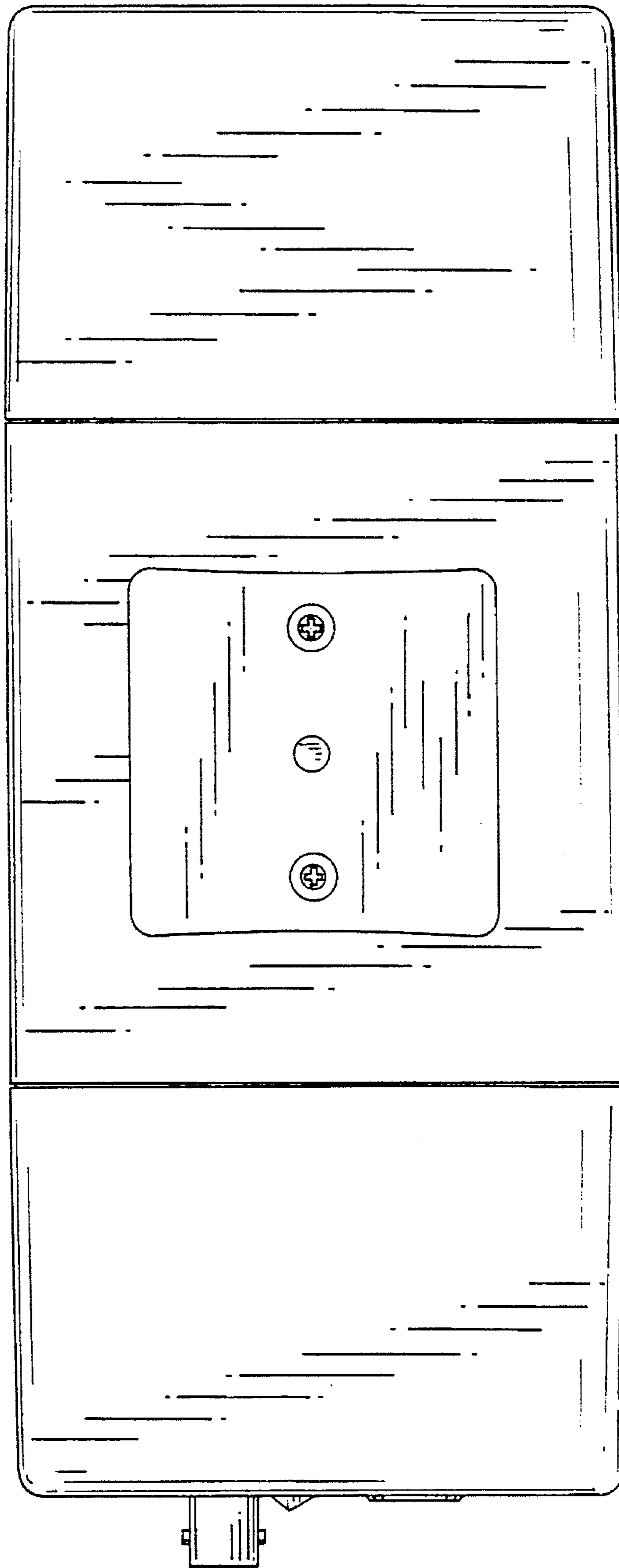

Fig. 5

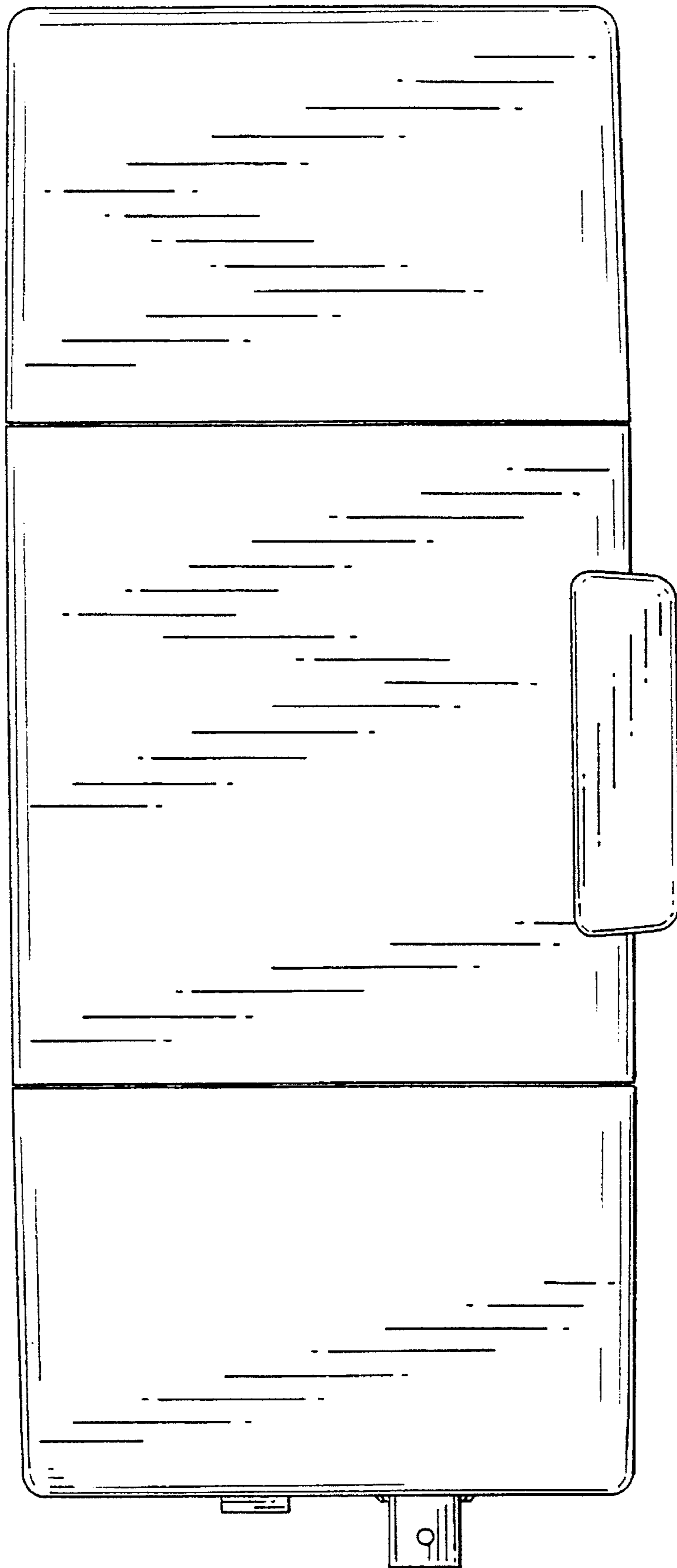



Fig. 6

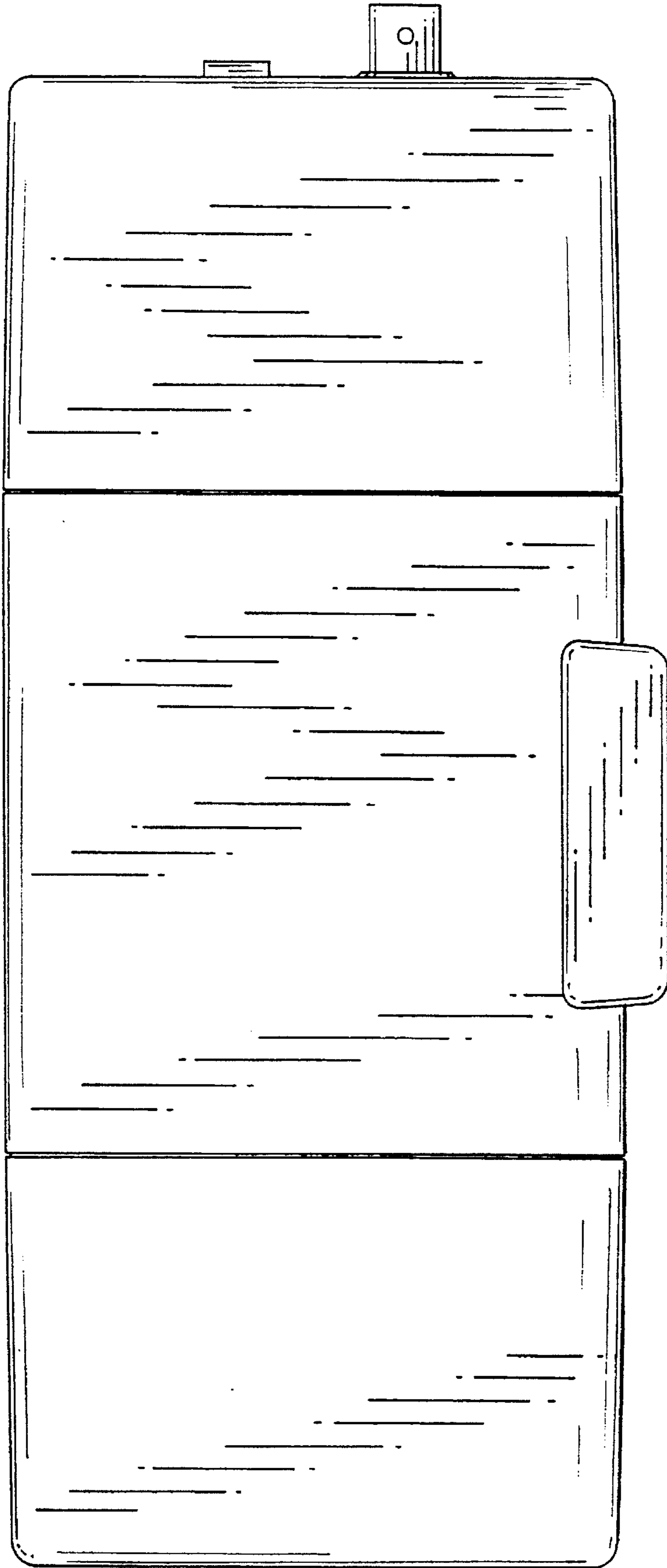

Fig. 7

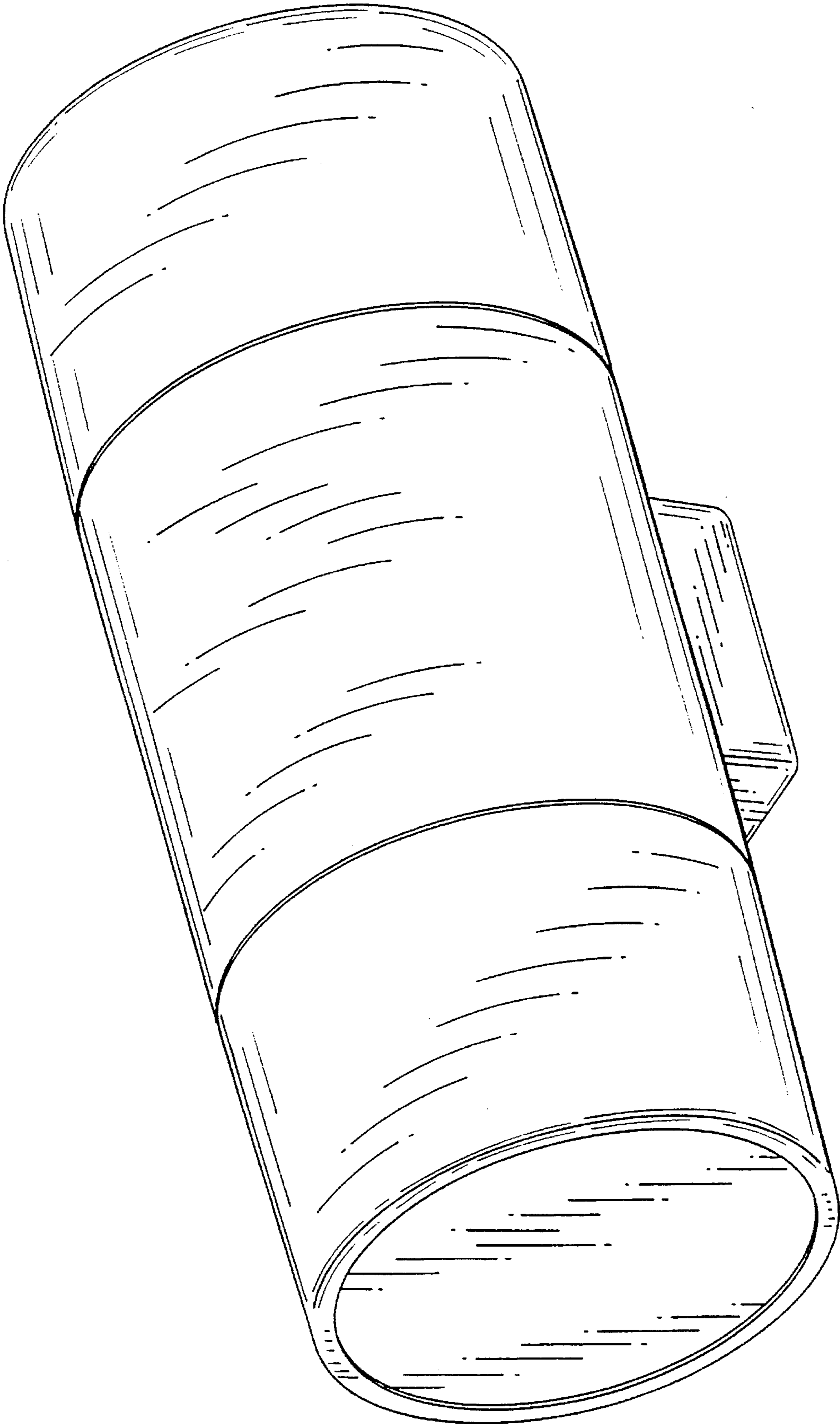



Fig. 8

