



US00D378066S

United States Patent [19]

[11] Patent Number: **Des. 378,066**

Doan

[45] Date of Patent: ****Feb. 18, 1997**

[54] **MEASUREMENT, SPACER AND BARRICADE WARNING TAPE**

[76] Inventor: **Duc T. Doan**, 4125 S. Figueroa St., Unit 301, Los Angeles, Calif. 90037

[**] Term: **14 Years**

[21] Appl. No.: **51,521**

[22] Filed: **Mar. 12, 1996**

[52] U.S. Cl. **D10/71**

[58] Field of Search D10/70, 71, 72, D10/61, 65, 109, 111, 113; D11/165-169, 181-183; D22/199; 33/483-494, 452, 465-471; 40/598; 116/173-175

[56] References Cited

U.S. PATENT DOCUMENTS

D. 210,097	2/1968	Covey	D10/71
D. 265,633	8/1982	Johnson	D10/71
D. 359,699	6/1995	Vandergriff et al.	D10/71
2,303,574	12/1942	Nail	33/485
3,803,718	4/1974	Schneider	33/490
5,471,749	12/1995	Brady	33/484

Primary Examiner—Antoine Duval Davis
Attorney, Agent, or Firm—Curtis L. Harrington

[57] CLAIM

The ornamental design for a measurement, spacer and barricade warning tape, as shown and described.

DESCRIPTION

FIG. 1 is a top view of the tape illustrating the spaced

apertures therein for spaced placement of rebar and further illustrating in phantom marking on the tape for both measurement and warning purposes;

FIG. 2 illustrates the tape of FIG. 1 in roll form;

FIG. 3 is a front side view of the tape as it is dispensed from its roll;

FIG. 4 is a rear side view of the tape as it is dispensed from its roll;

FIG. 5 is a bottom side view of the tape as it is dispensed from its roll;

FIG. 6 is an expanded view of the tape as shown in FIG. 1 and illustrated with a "Caution" warning shown in phantom;

FIG. 7 is an expanded view of the tape as shown in FIG. 1 and illustrated with a "Do Not Cross This Line" warning shown in phantom;

FIG. 8 is an expanded view of the measurement, spacer and barricade warning tape as shown in FIG. 1 and illustrated with a "Danger Peligro Danger" warning shown in phantom; and,

FIG. 9 is a perspective view thereof.

The broken line showing is for illustrative purposes only and forms no part of the claimed design.

1 Claim, 3 Drawing Sheets

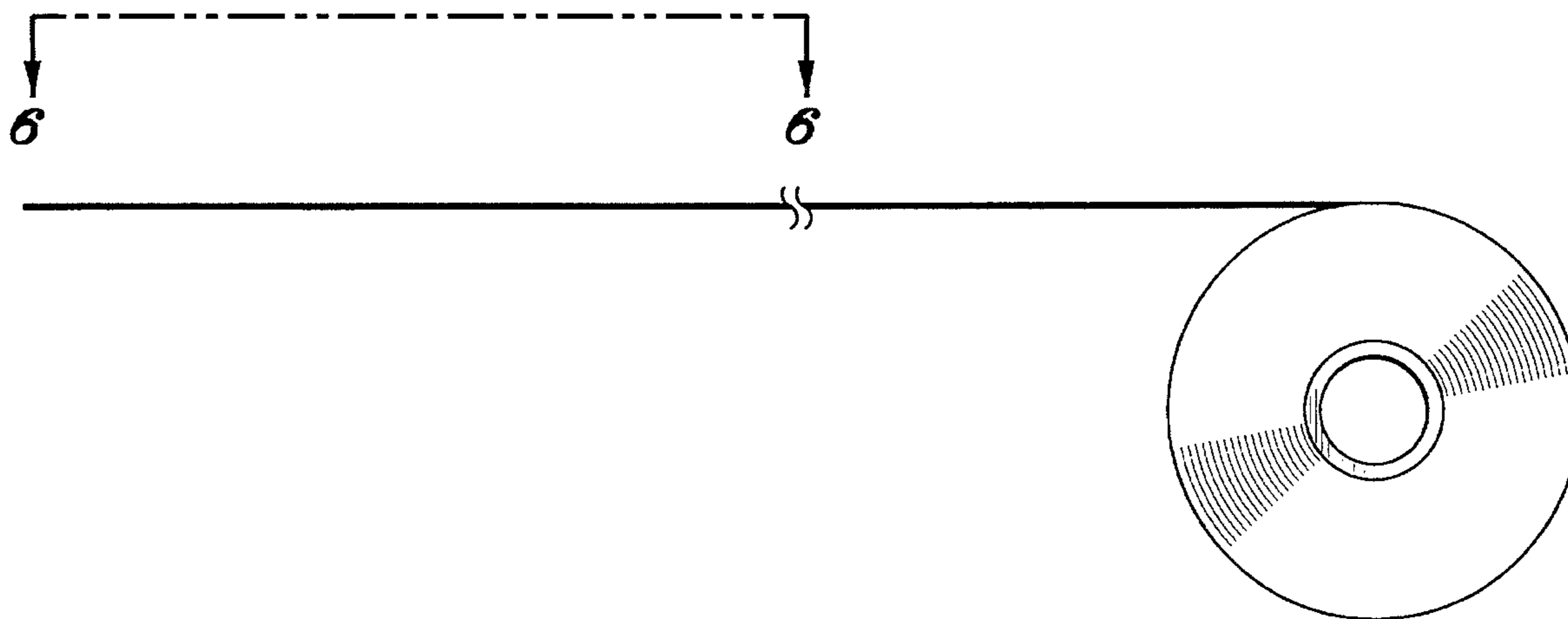
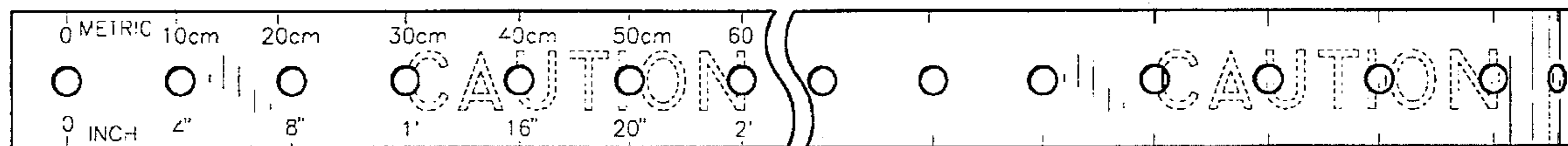

Fig. 1

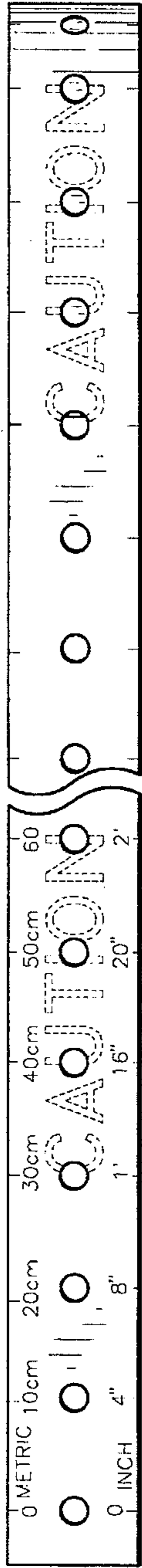

Fig. 2

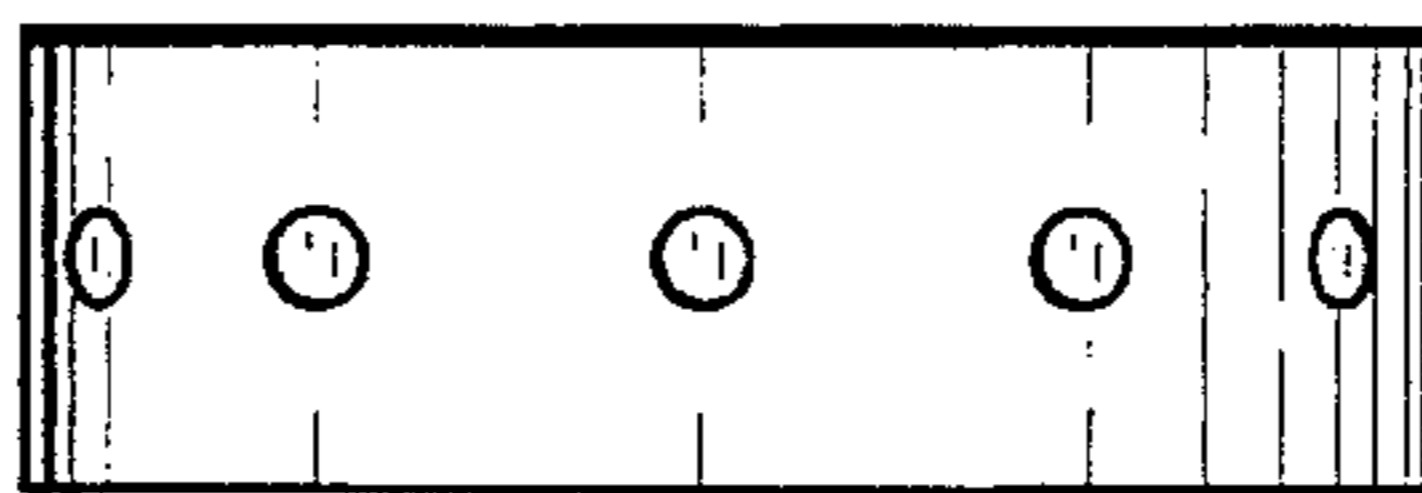

Fig. 3

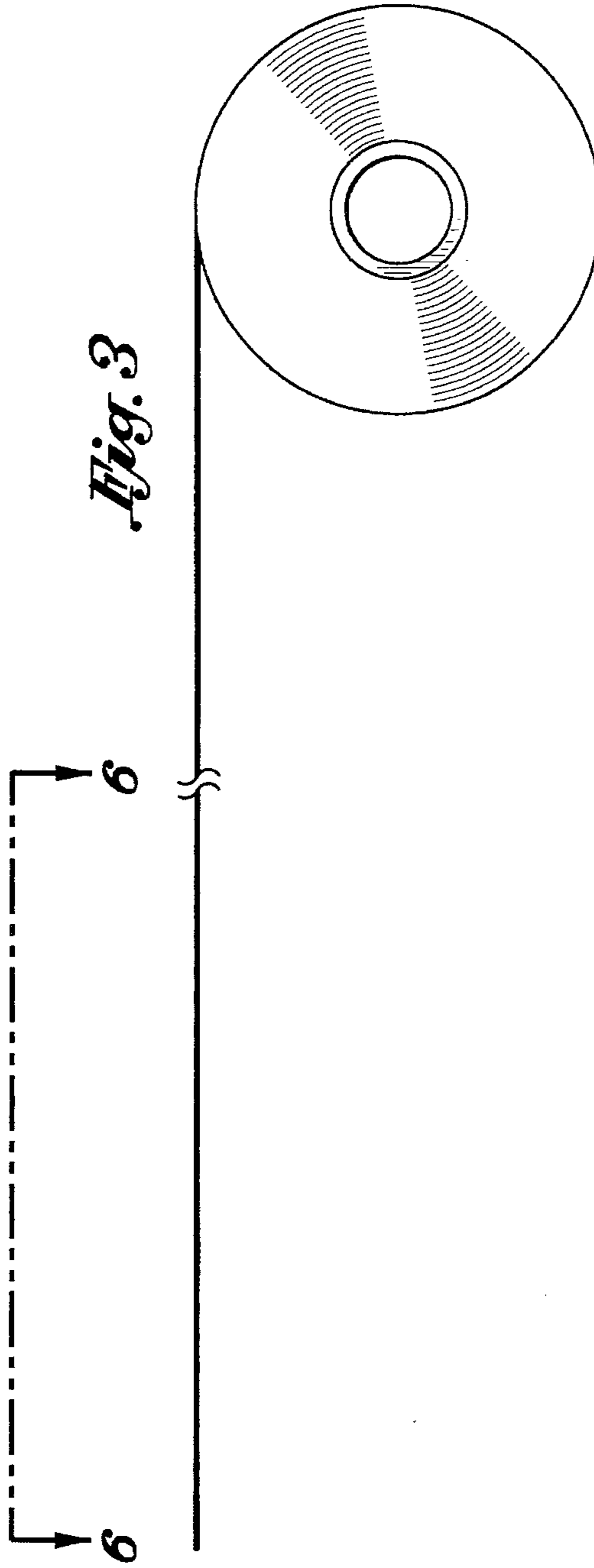

Fig. 4

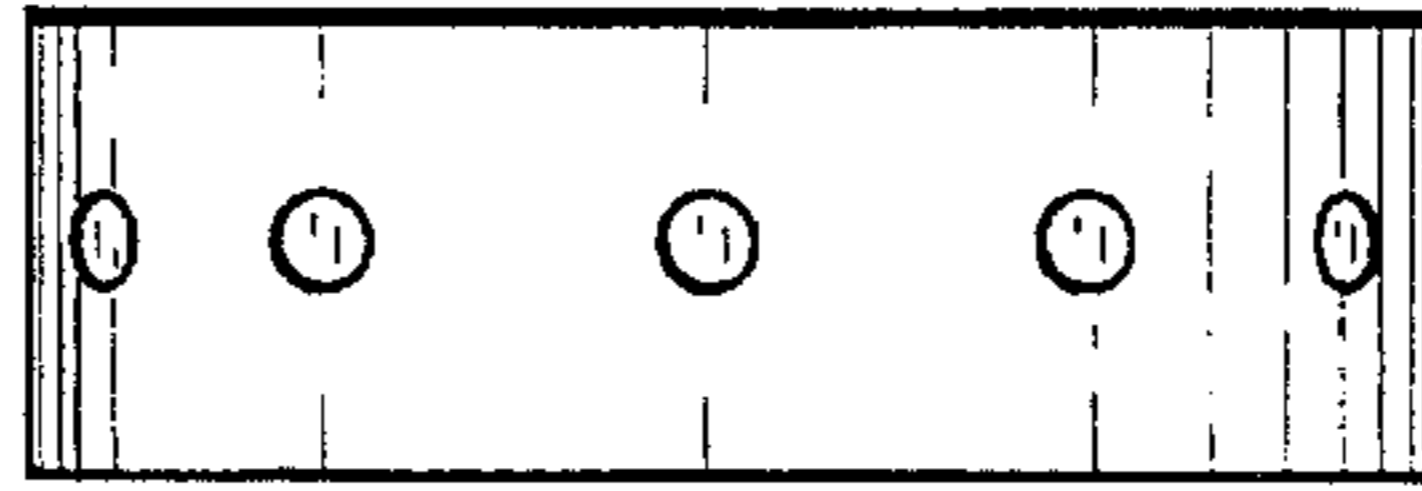

Fig. 5

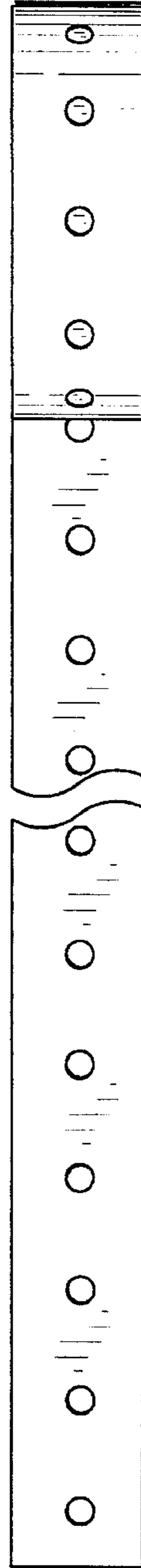

Fig. 6

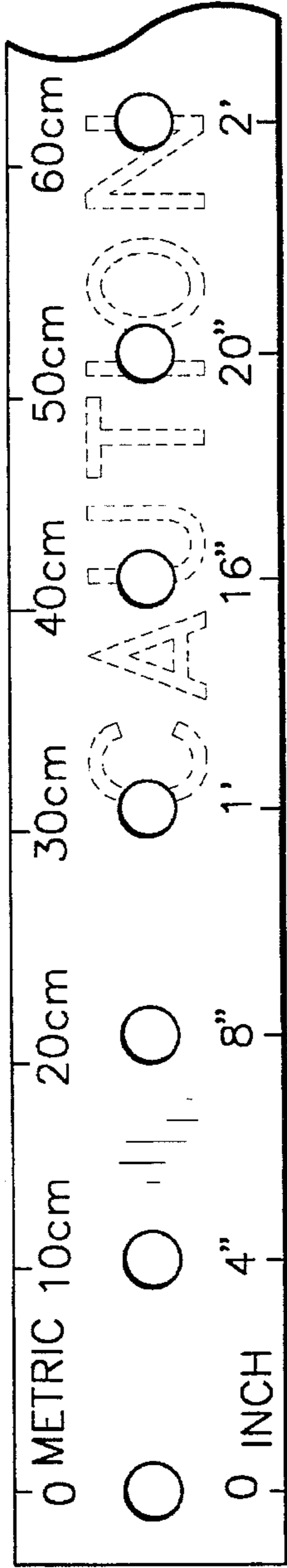

Fig. 7

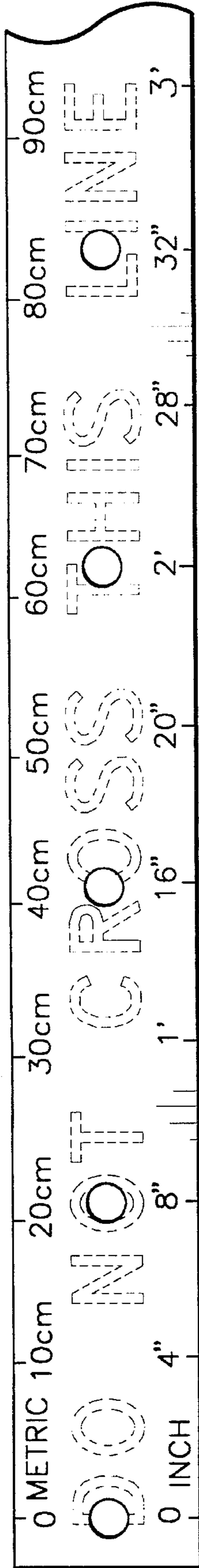
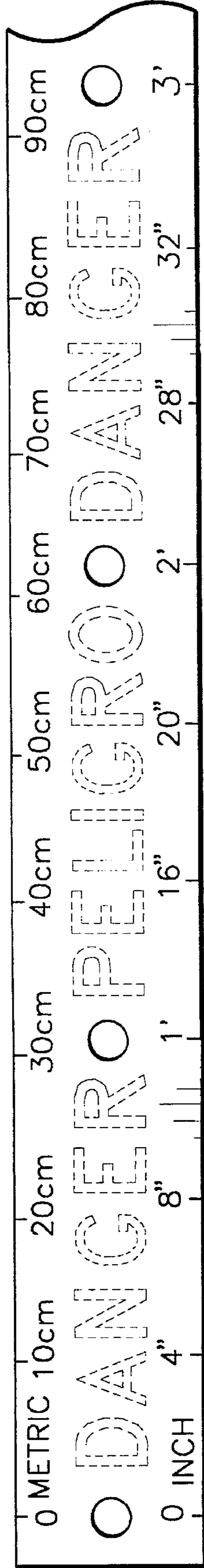

Fig. 8



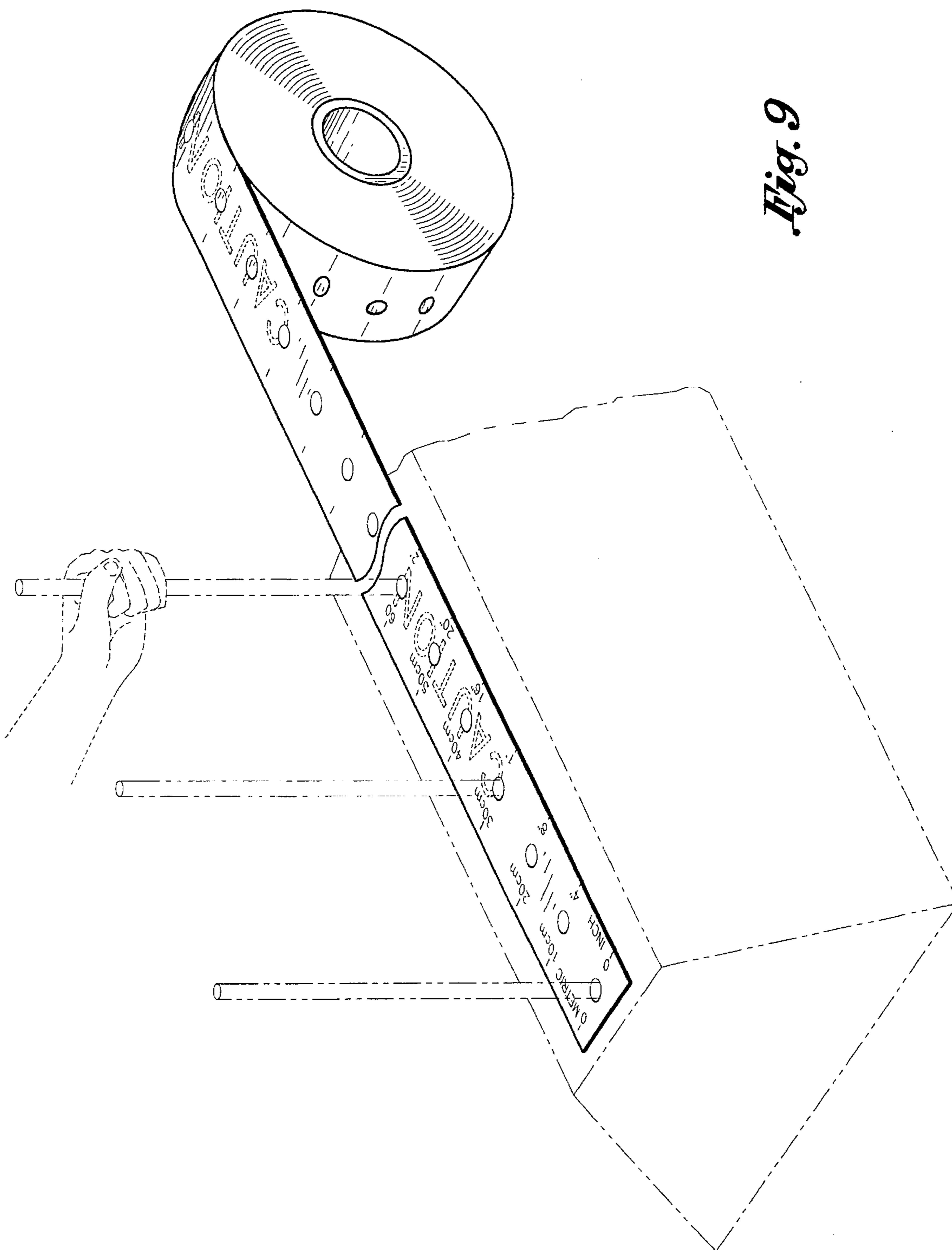

Fig. 9