



US00D378051S

United States Patent [19]

Shinano

[11] Patent Number: **Des. 378,051**

[45] Date of Patent: ****Feb. 18, 1997**

[54] **STAND FOR IMAGE DISPLAYING DEVICE**

[75] Inventor: **Toru Shinano**, Yokohama, Japan

[73] Assignee: **Canon Kabushiki Kaisha**, Toyko, Japan

[**] Term: **14 Years**

[21] Appl. No.: **42,770**

[22] Filed: **Aug. 17, 1995**

[30] Foreign Application Priority Data

Feb. 21, 1995 [JP] Japan 7-4405

[52] U.S. Cl. **D8/373**

[58] Field of Search D14/114, 217, D14/239; D8/349, 354, 373, 380; D6/329, 396, 449, 512; 248/670, 220.2, 235, 241, 274, 284, 281.1, 291, 310; 211/96, 100

[56] References Cited

U.S. PATENT DOCUMENTS

D. 337,719 7/1993 Burns D8/363

D. 352,652	11/1994	Vogels	D8/363
D. 359,035	6/1995	Shinano	D14/113
D. 371,065	6/1996	Shinano et al.	D8/373
3,916,627	11/1975	Carlisle et al.	248/310 X
4,659,047	4/1987	Haller	248/310 X

Primary Examiner—Brian N. Vinson
Attorney, Agent, or Firm—Fitzpatrick, Cella, Harper & Scinto

[57] CLAIM

The ornamental design for a stand for image displaying device, as shown and described.

DESCRIPTION

FIG. 1 is a front elevational view of a stand for image displaying device showing my new design; FIG. 2 is a rear elevational view thereof; FIG. 3 is a top plan view thereof; FIG. 4 is a bottom plan view thereof; FIG. 5 is a left side elevational view thereof; FIG. 6 is a right side elevational view thereof; and, FIG. 7 is a perspective view thereof.

1 Claim, 4 Drawing Sheets

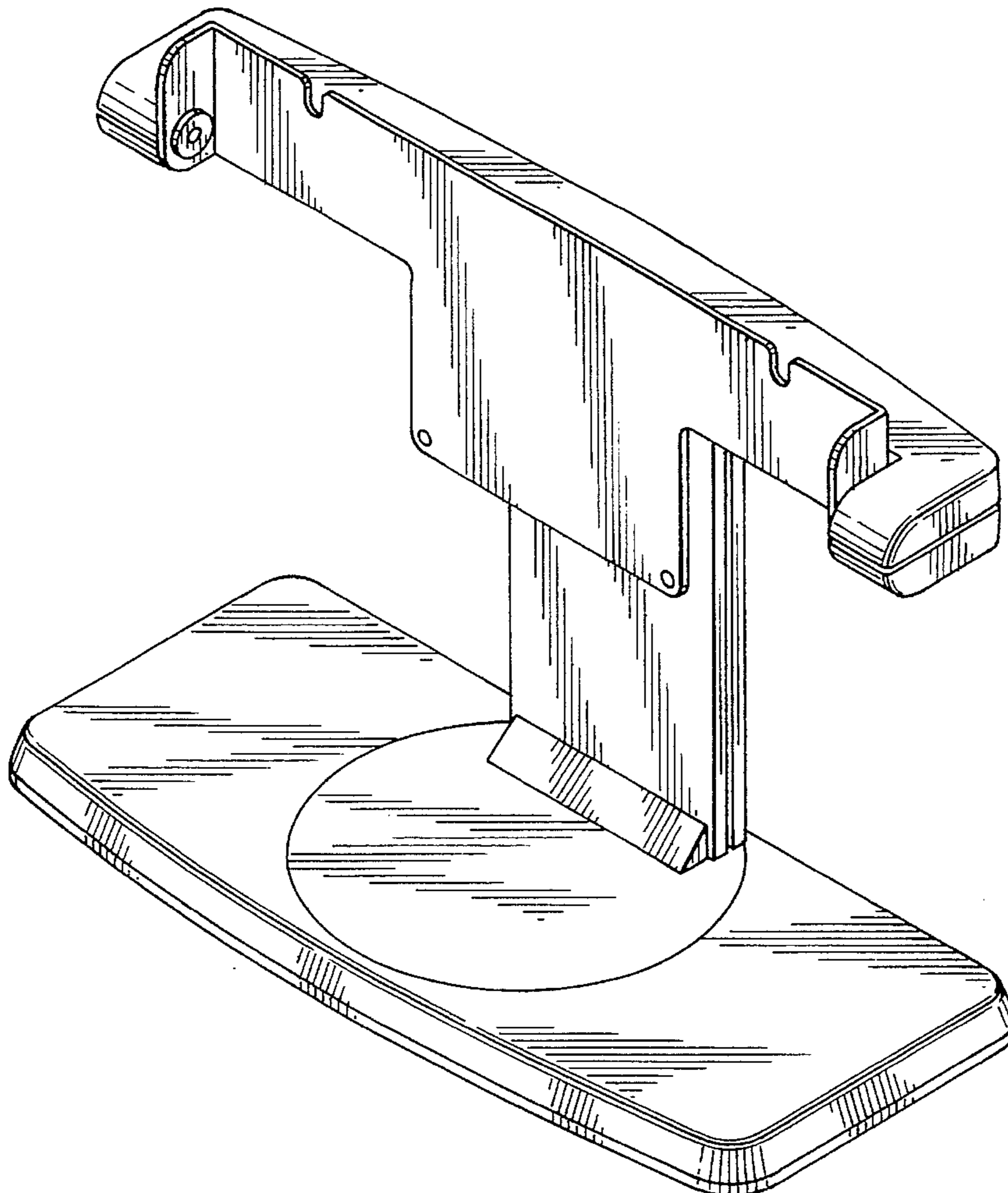

FIG. 1

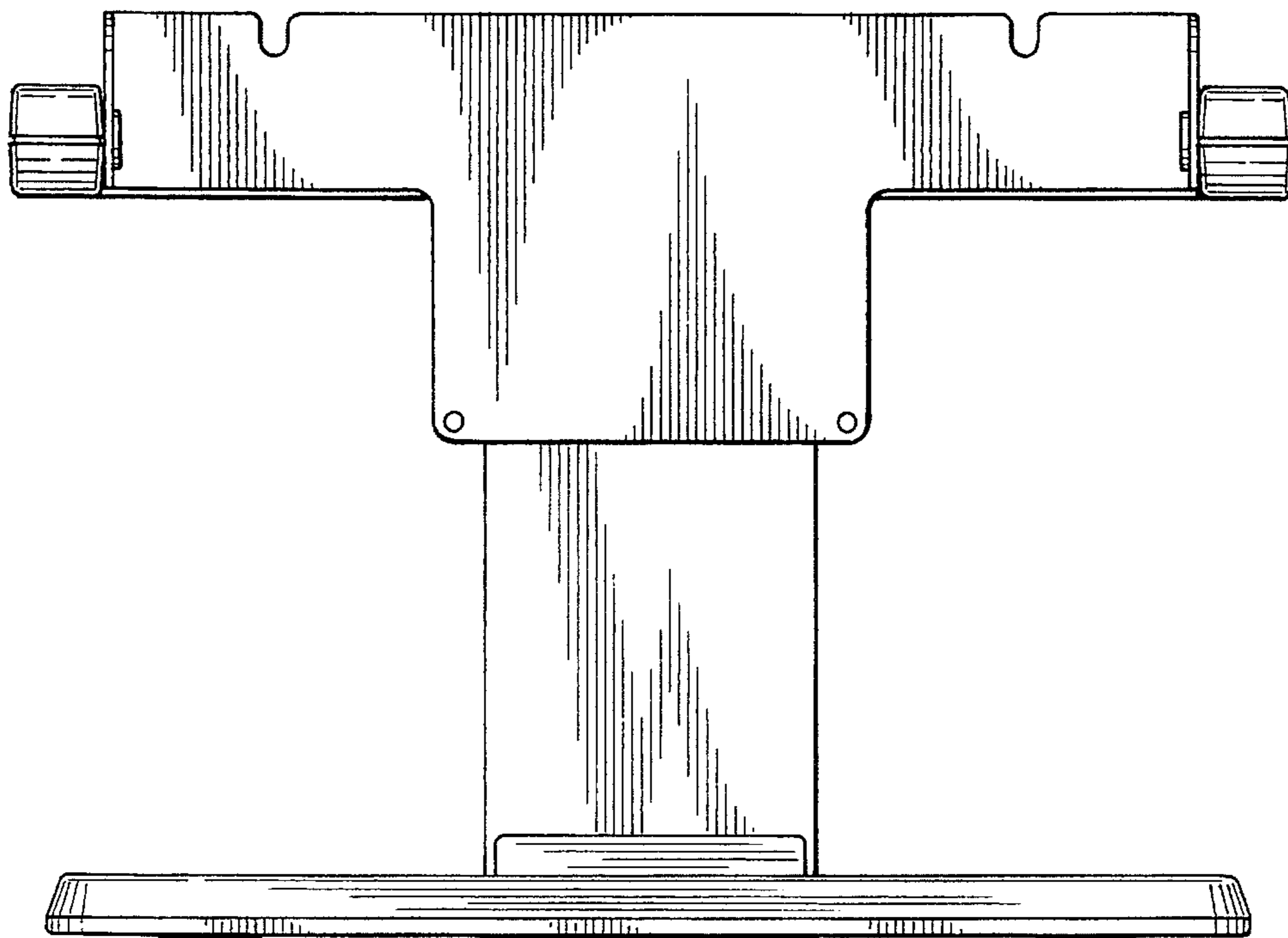

FIG. 2

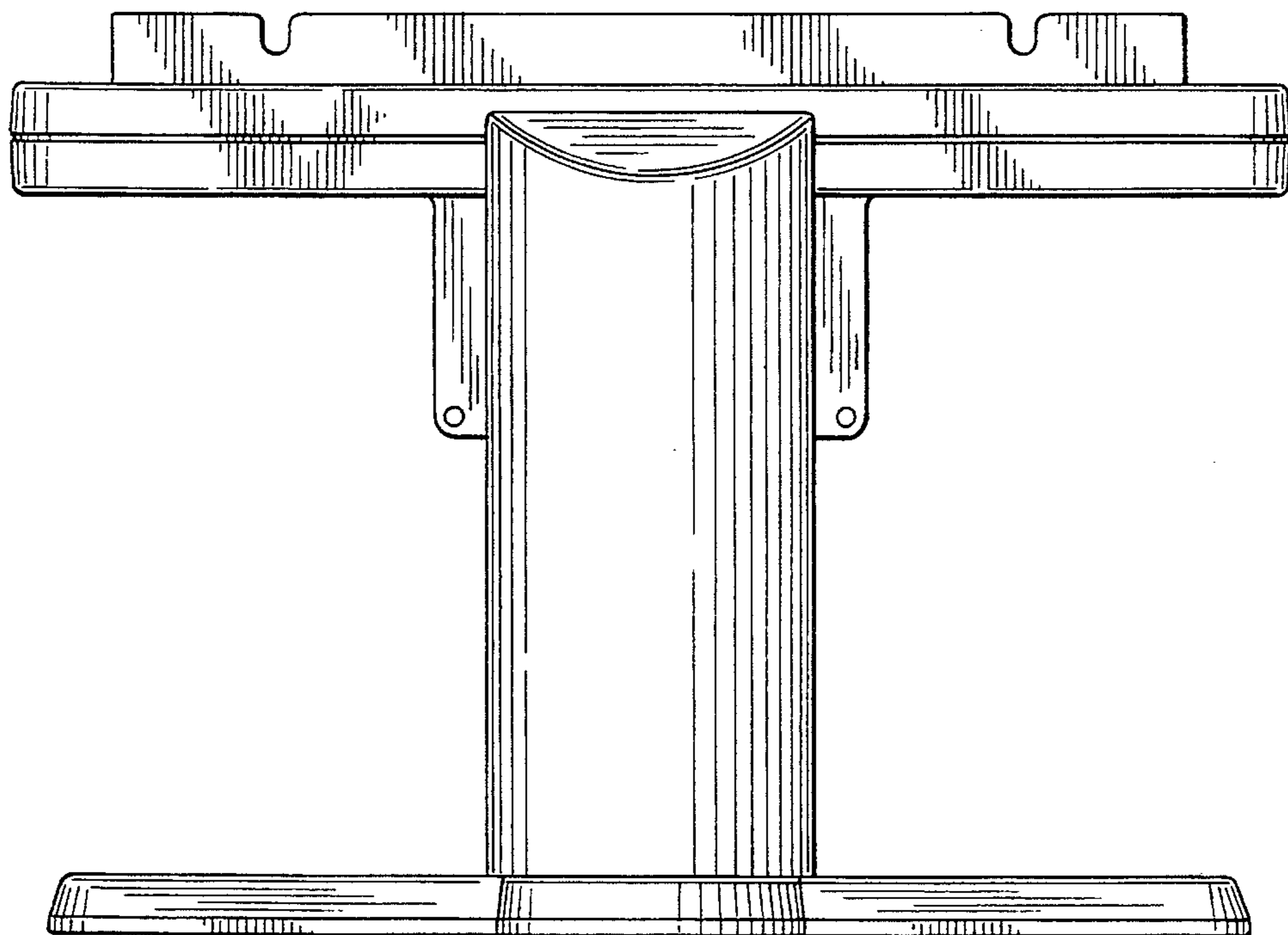

FIG. 3

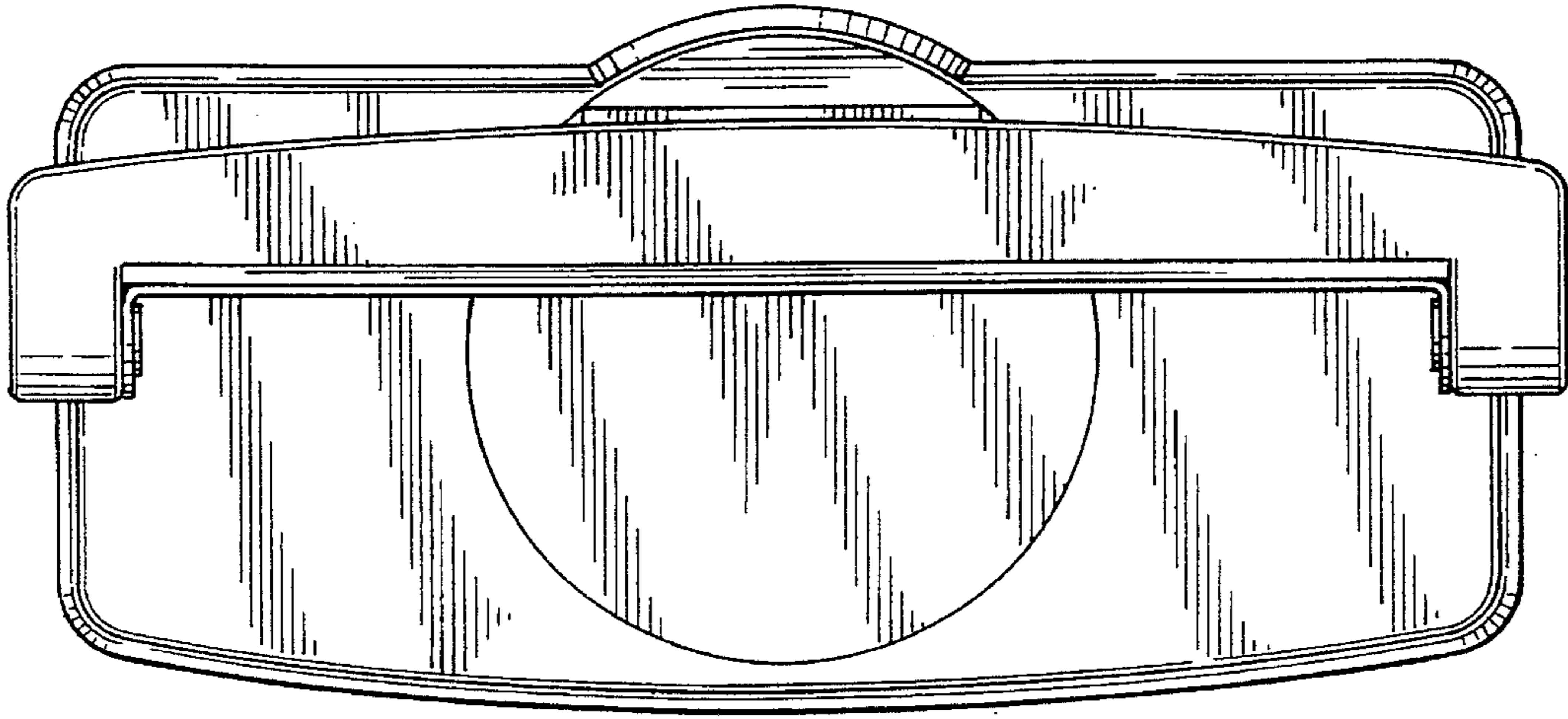

FIG. 4

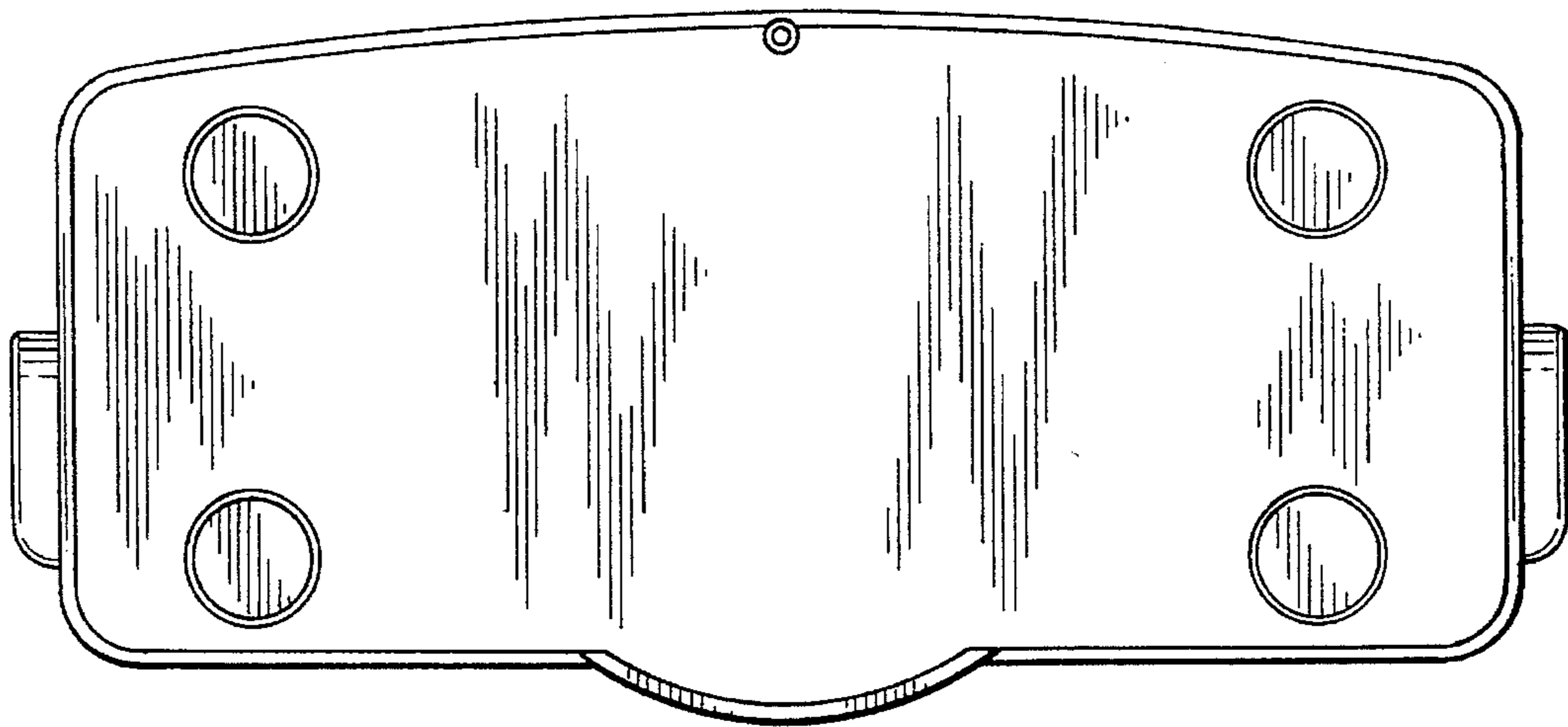

FIG. 5

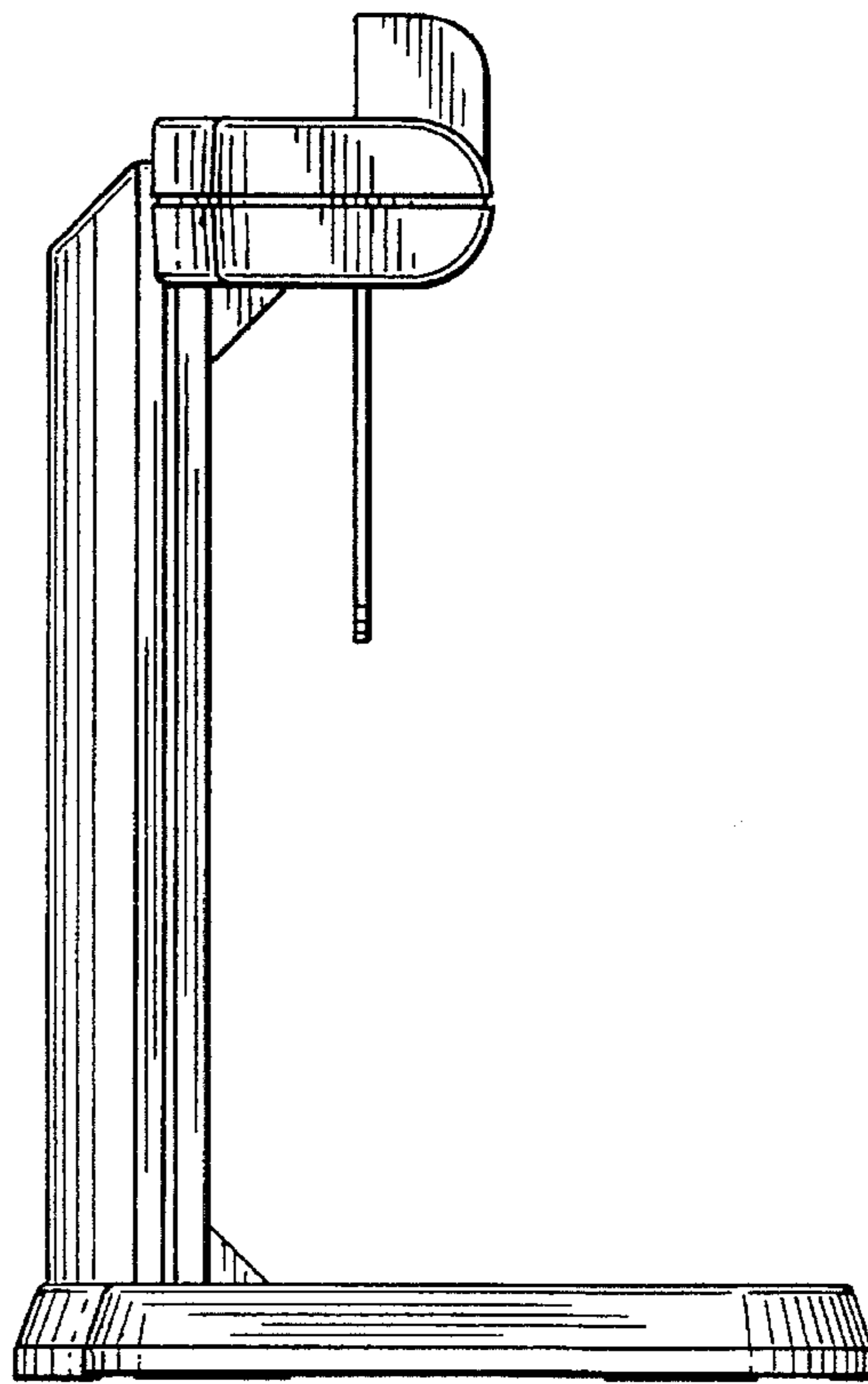

FIG. 6

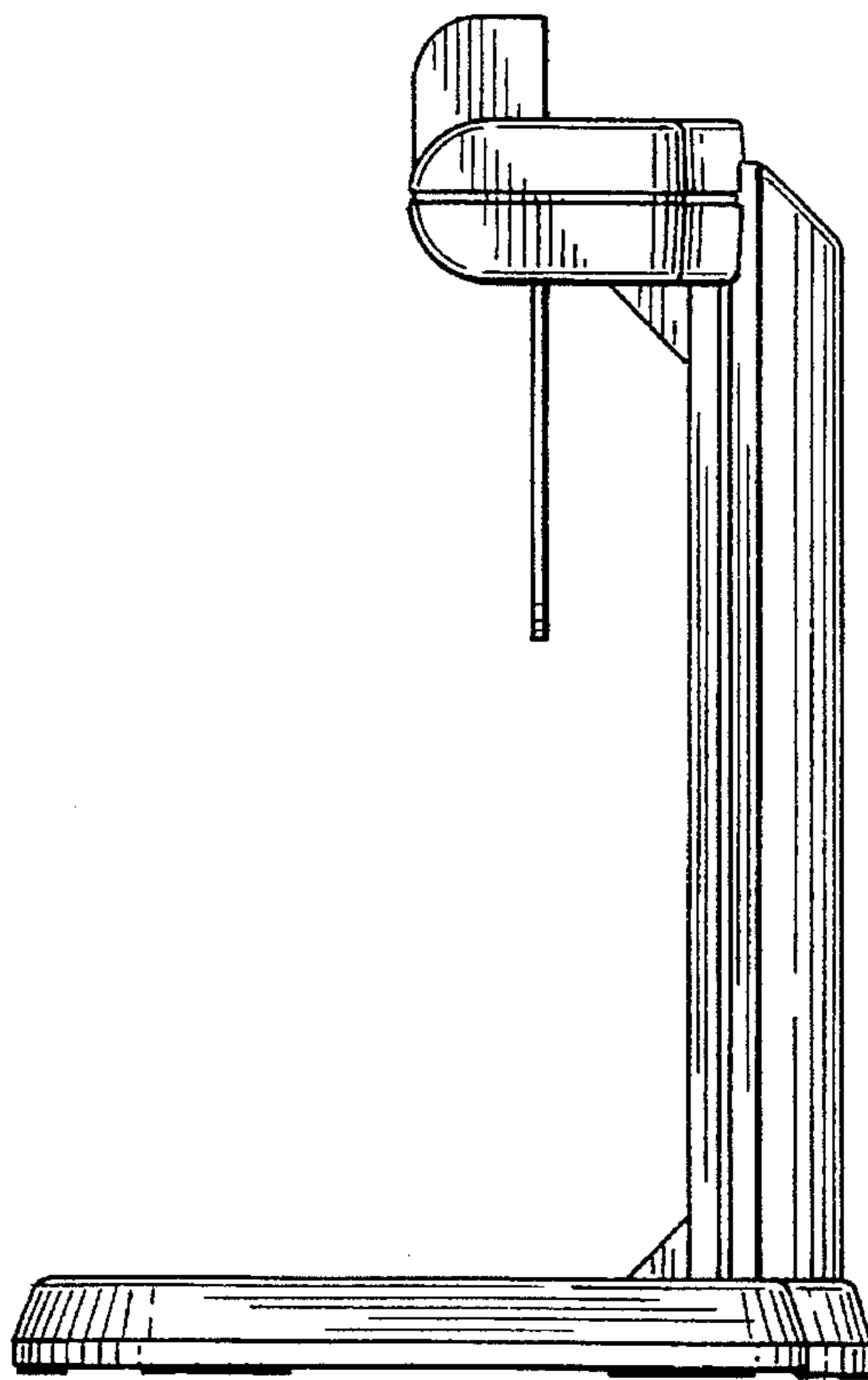

FIG. 7

