



US00D377843S

**United States Patent** [19]  
**Schering**

[11] **Patent Number: Des. 377,843**  
[45] **Date of Patent: \*\*Feb. 4, 1997**

[54] **CHRISTMANS TREE LIGHT HOLDER**

[76] Inventor: **June M. Schering**, 1615 27th St., NW.,  
Canton, Ohio 44709

[\*\*] Term: **14 Years**

[21] Appl. No.: **40,740**

[22] Filed: **Jun. 26, 1995**

[52] U.S. Cl. .... **D26/138**

[58] **Field of Search** ..... D26/25, 138, 140;  
362/806, 382, 391-392, 396, 810, 249,  
252, 123, 419, 250; D8/356, 358; 174/153 CA;  
248/65, 314, 328, 74.2, 56; 24/30.5; D11/130

[56] **References Cited**

**U.S. PATENT DOCUMENTS**

4,404,621	9/1983	Mauro	362/419
4,705,483	11/1987	Davis	439/502
4,736,282	4/1988	Ahroni	362/123
4,769,749	9/1988	Felski	362/250
5,150,963	9/1992	Hill	362/123

*Primary Examiner*—Holly H. Baynham  
*Attorney, Agent, or Firm*—Sand & Sebolt

[57] **CLAIM**

The ornamental design for a Christmas tree light holder, as shown and described.

**DESCRIPTION**

FIG. 1 is a diagrammatic perspective view of a Christmas tree light holder showing my new design in use holding

lights on a Christmas tree

FIG. 2 is an enlarged perspective view of a Christmas tree light holder;

FIG. 3 is a reduced top plan view of FIG. 2;

FIG. 4 is a bottom plan view of FIG. 3;

FIG. 5 is a front elevational view of FIG. 3;

FIG. 6 is a rear elevational view of FIG. 3;

FIG. 7 is a right side elevational view of FIG. 3;

FIG. 8 is a left side elevational view of FIG. 3;

FIG. 9 is a top plan view of a second embodiment of a Christmas tree light holder showing my new design;

FIG. 10 is a bottom plan view of FIG. 9;

FIG. 11 is a front elevational view of FIG. 9;

FIG. 12 is a rear elevational view of FIG. 9;

FIG. 13 is a right side elevational view of FIG. 9;

FIG. 14 is a left side elevational view of FIG. 9;

FIG. 15 is a top plan view of a third embodiment of a Christmas tree light holder showing my new design;

FIG. 16 is a bottom plan view of FIG. 15;

FIG. 17 is a front elevational view of FIG. 15;

FIG. 18 is a rear elevational view of FIG. 15;

FIG. 19 is a right side elevational view of FIG. 15; and,

FIG. 20 is a left side elevational view of FIG. 15.

The broken lines showing portions of a Christmas tree and strands of lights attached to the Christmas tree light holder of the present invention are for illustrative purposes only and form no part of the claimed design.

**1 Claim, 4 Drawing Sheets**

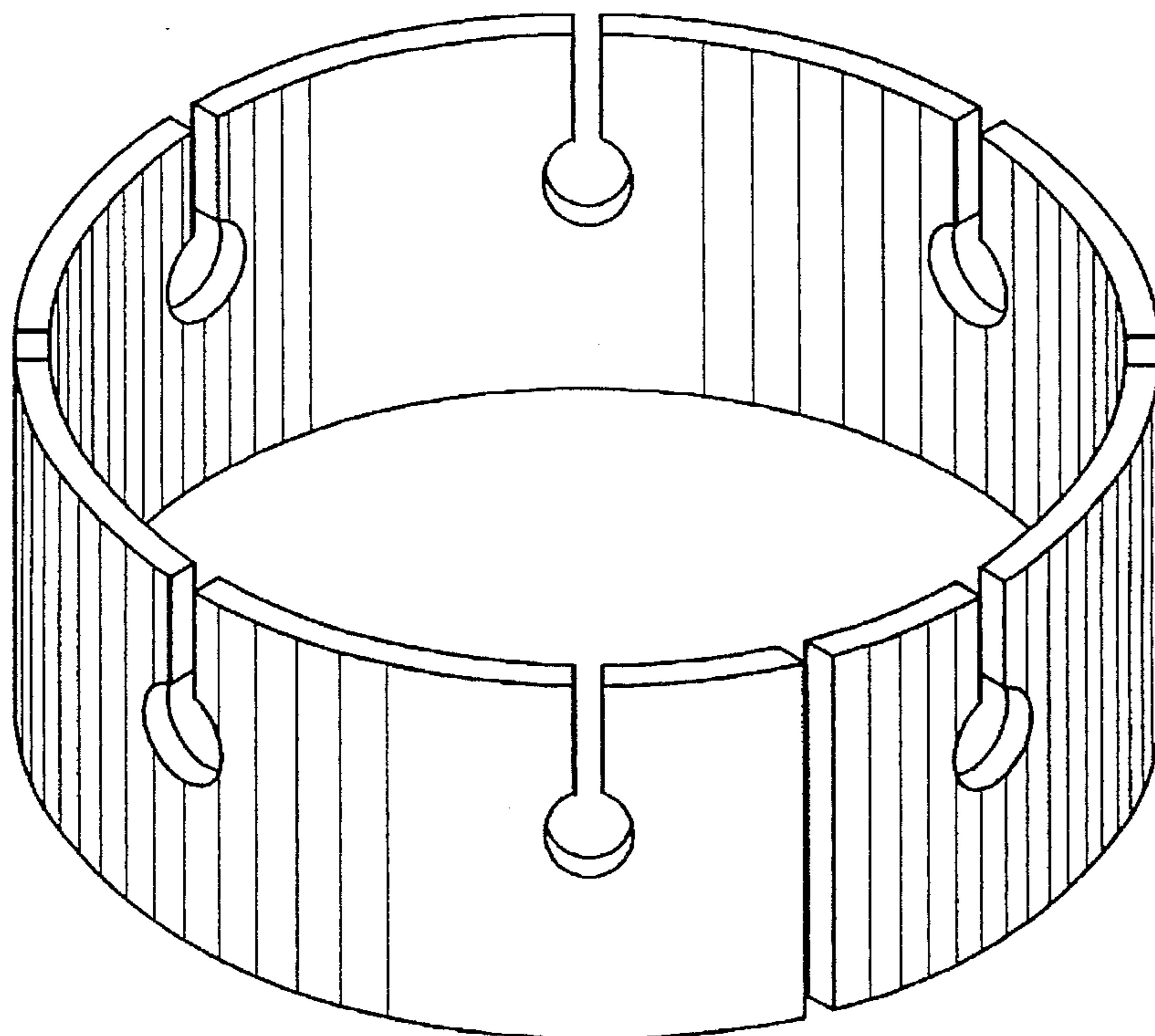

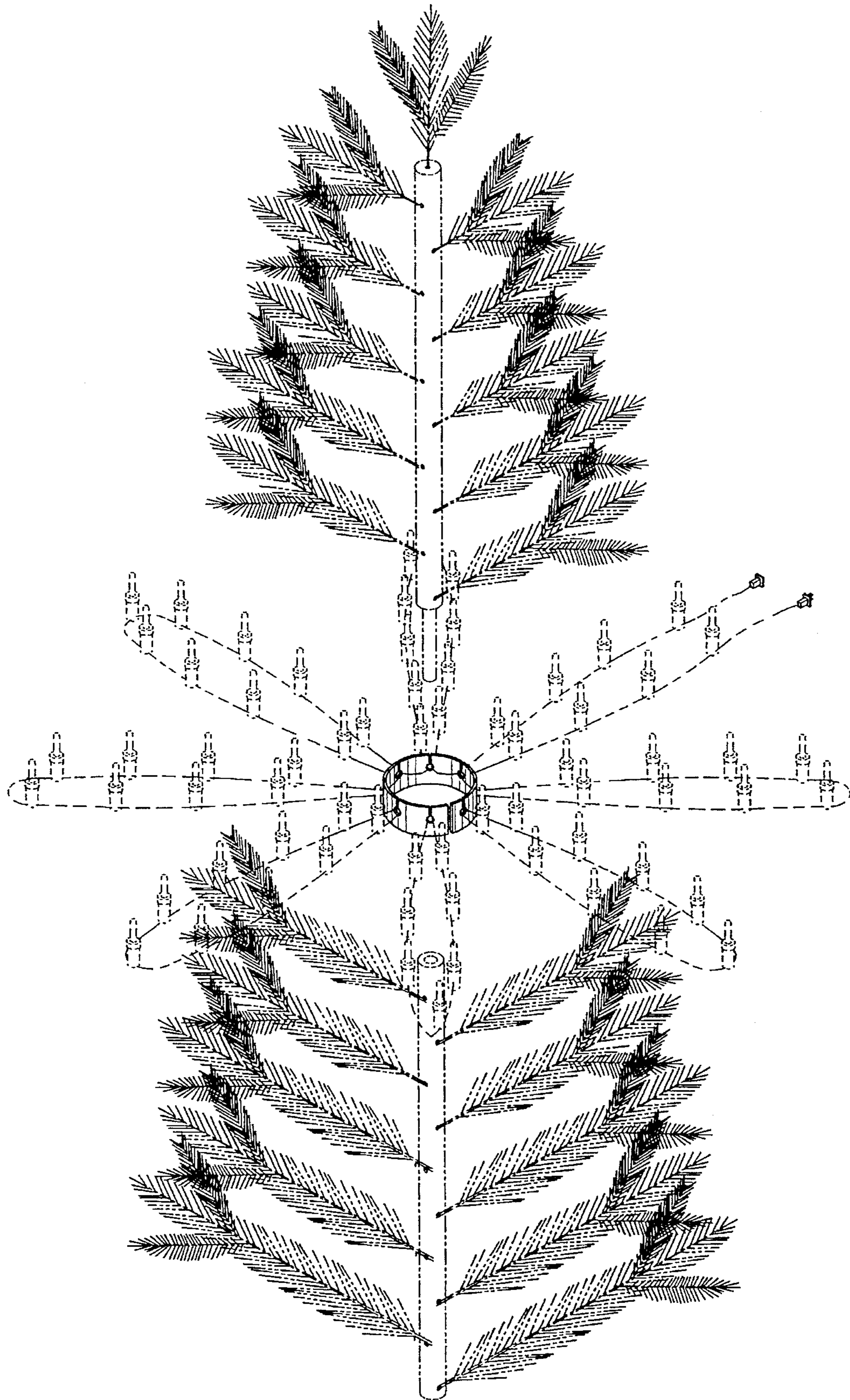

FIG. 1



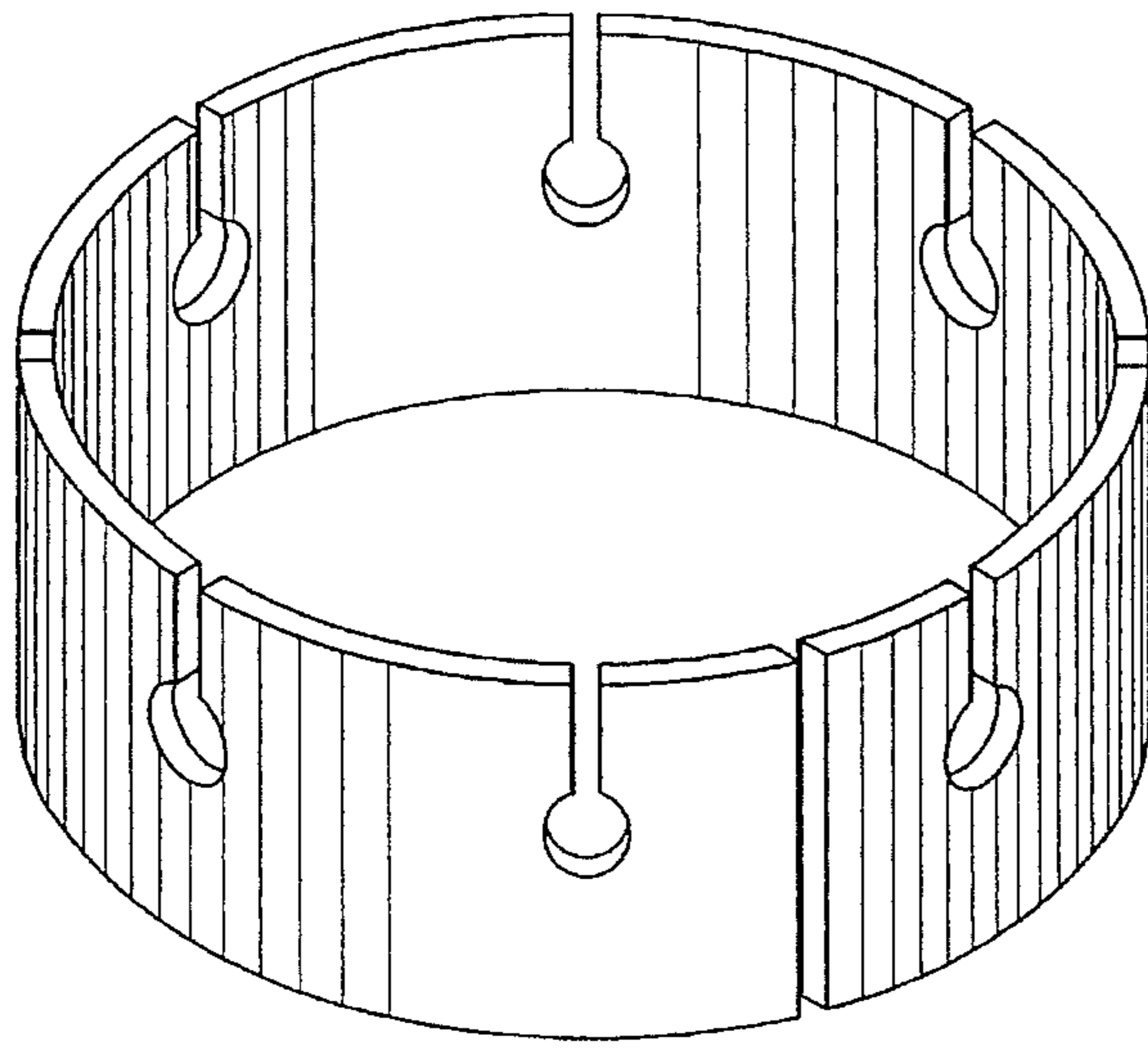

FIG. 2

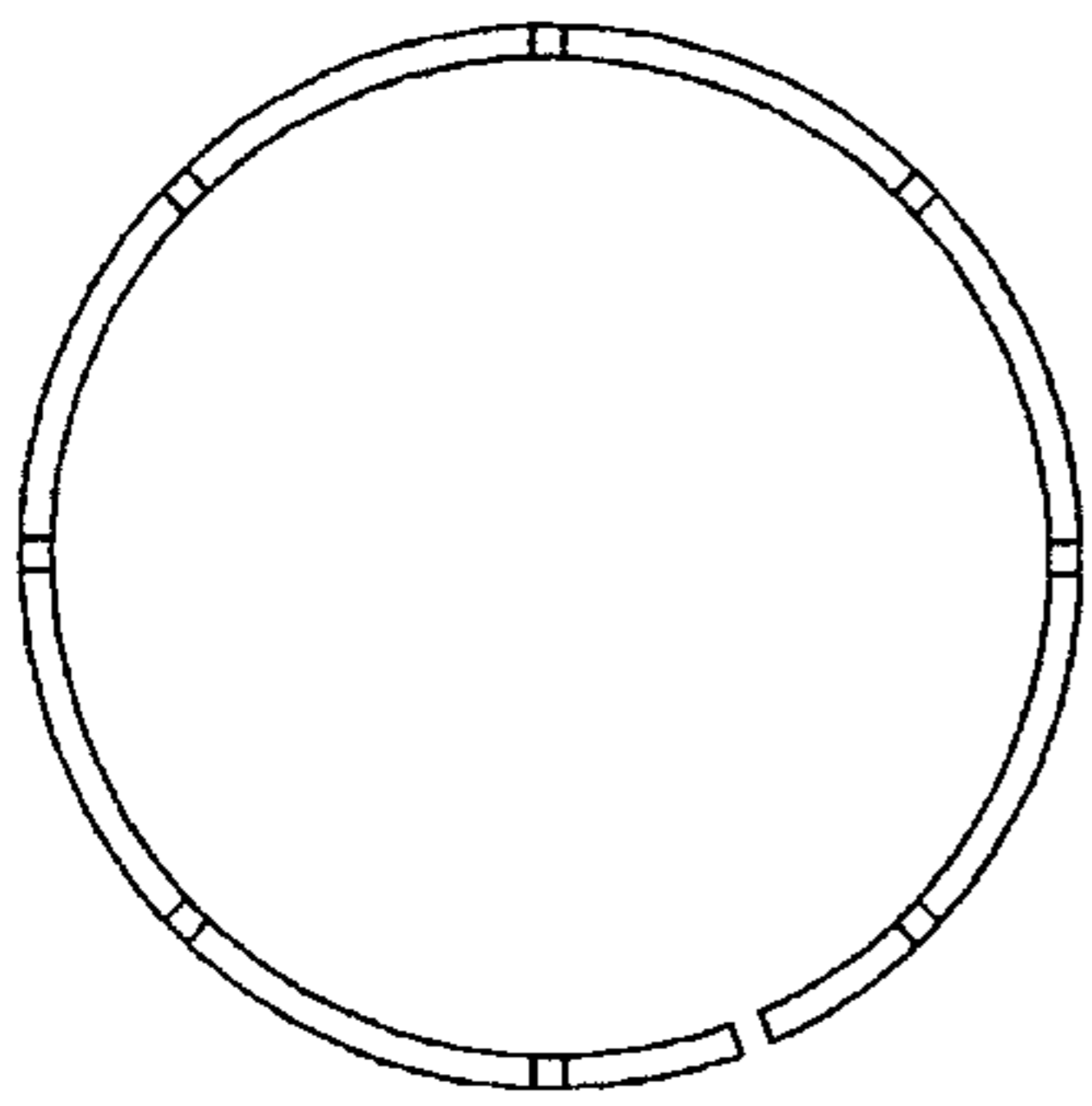

FIG. 3

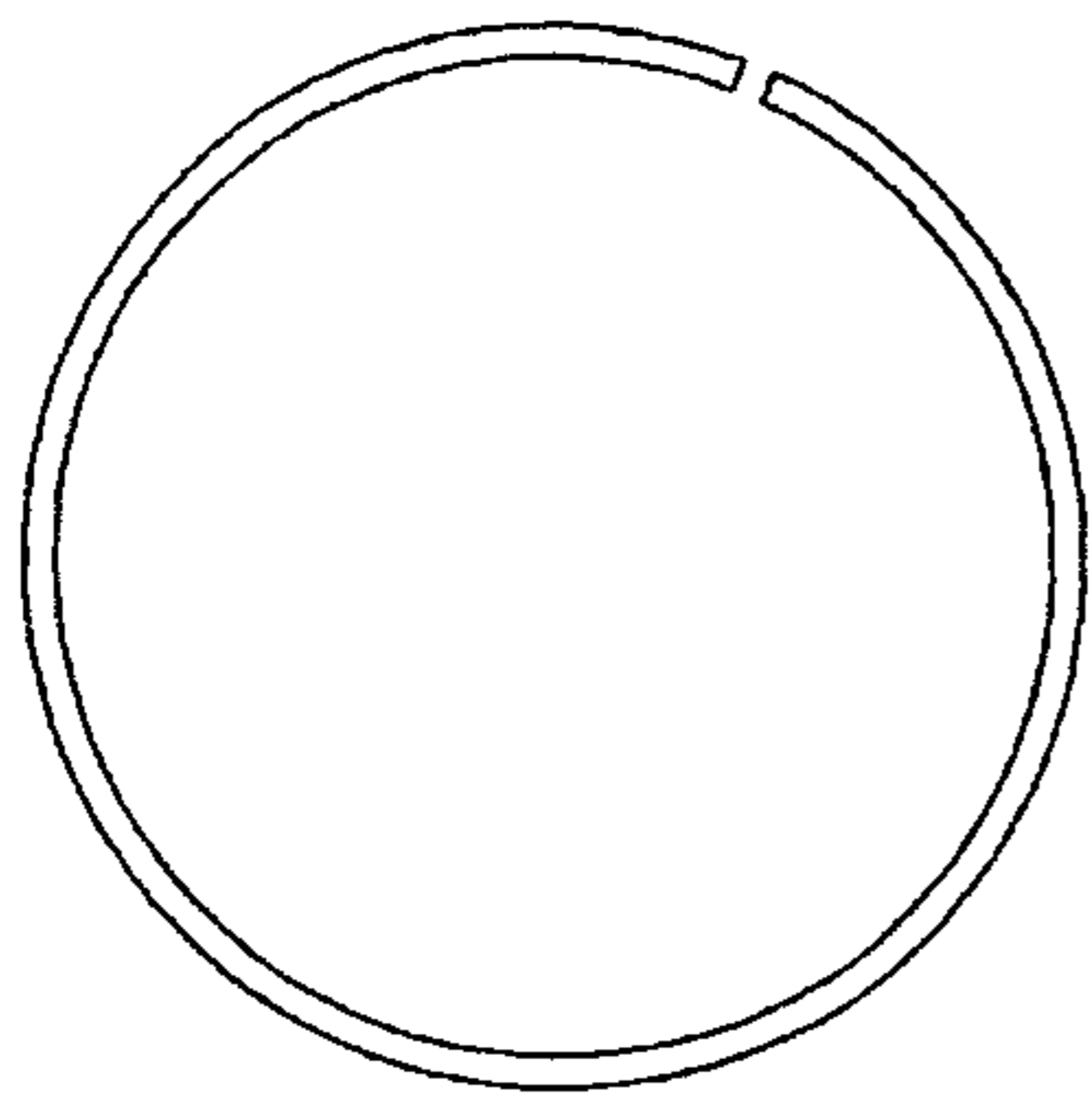

FIG. 4

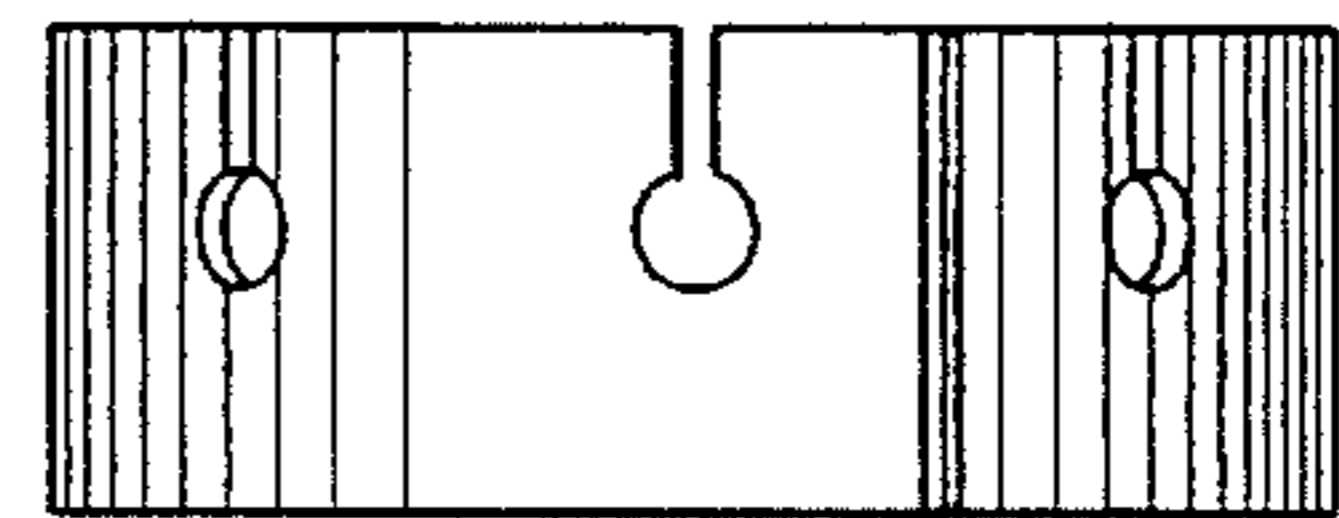

FIG. 5

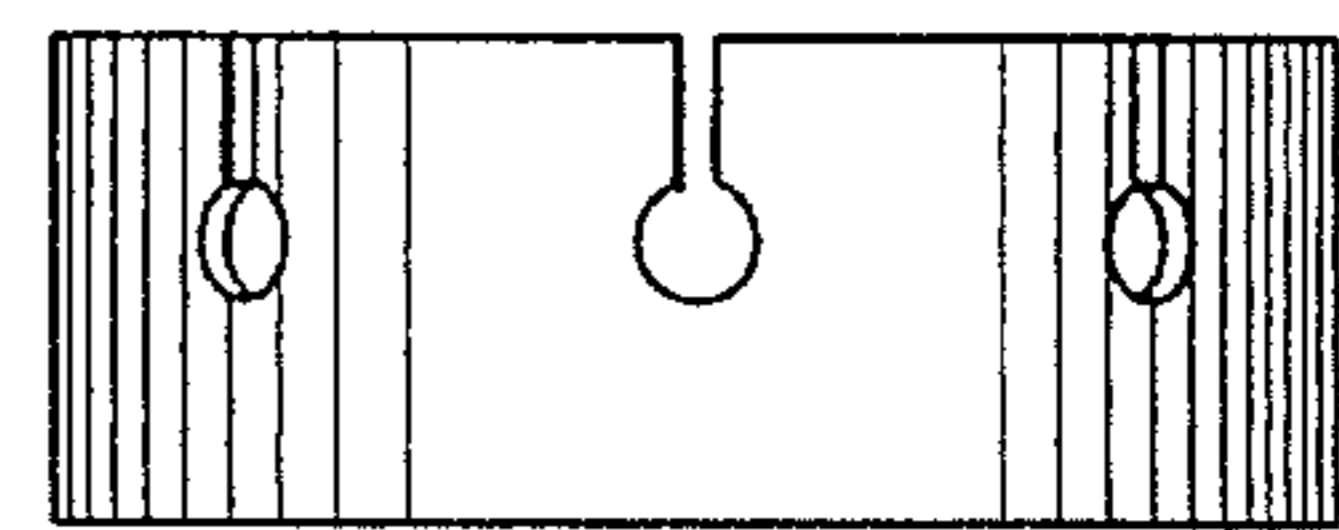

FIG. 6

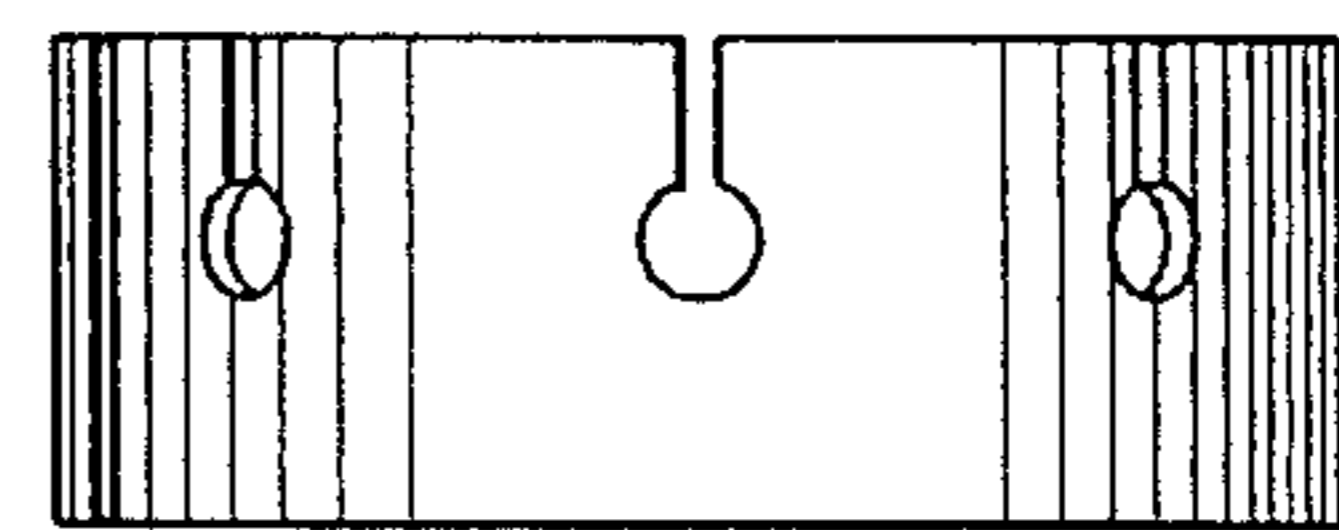

FIG. 7

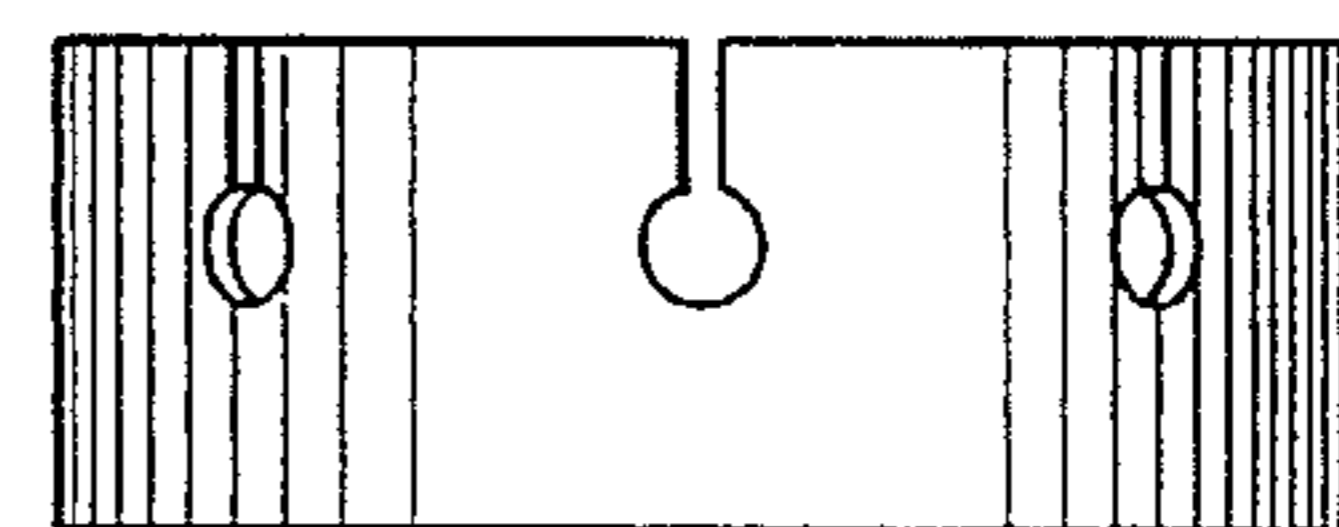

FIG. 8

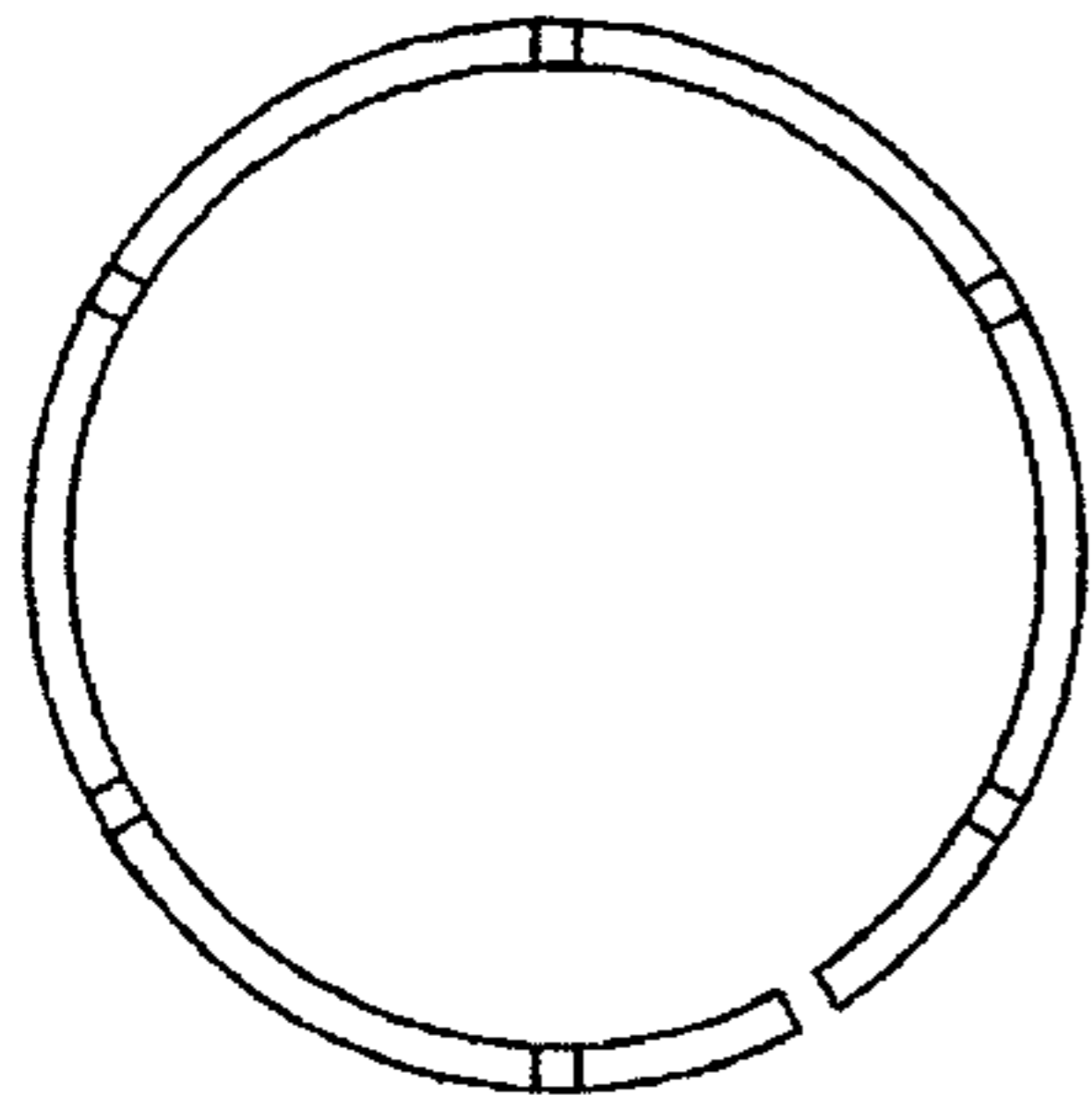

FIG. 9

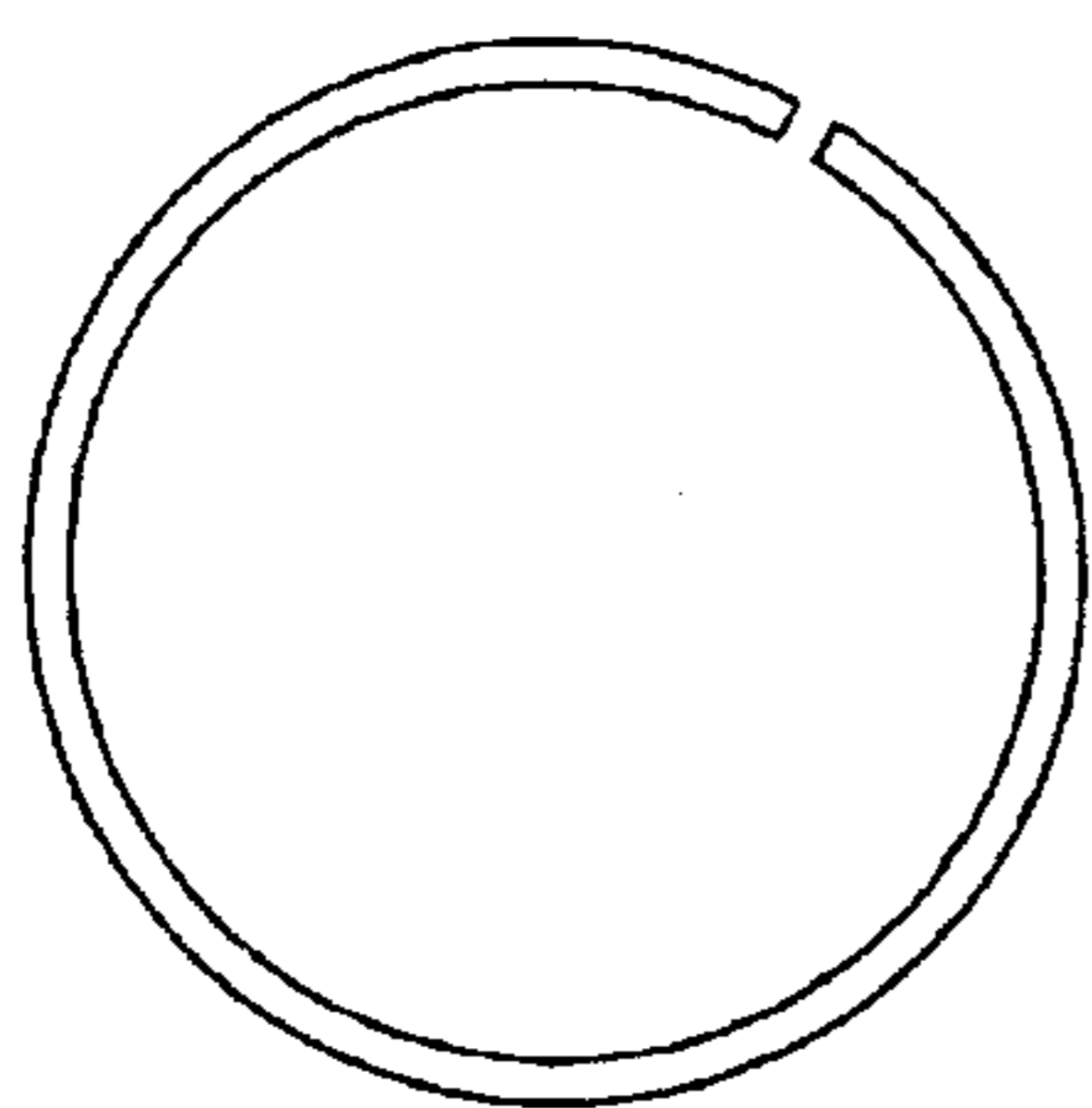

FIG. 10

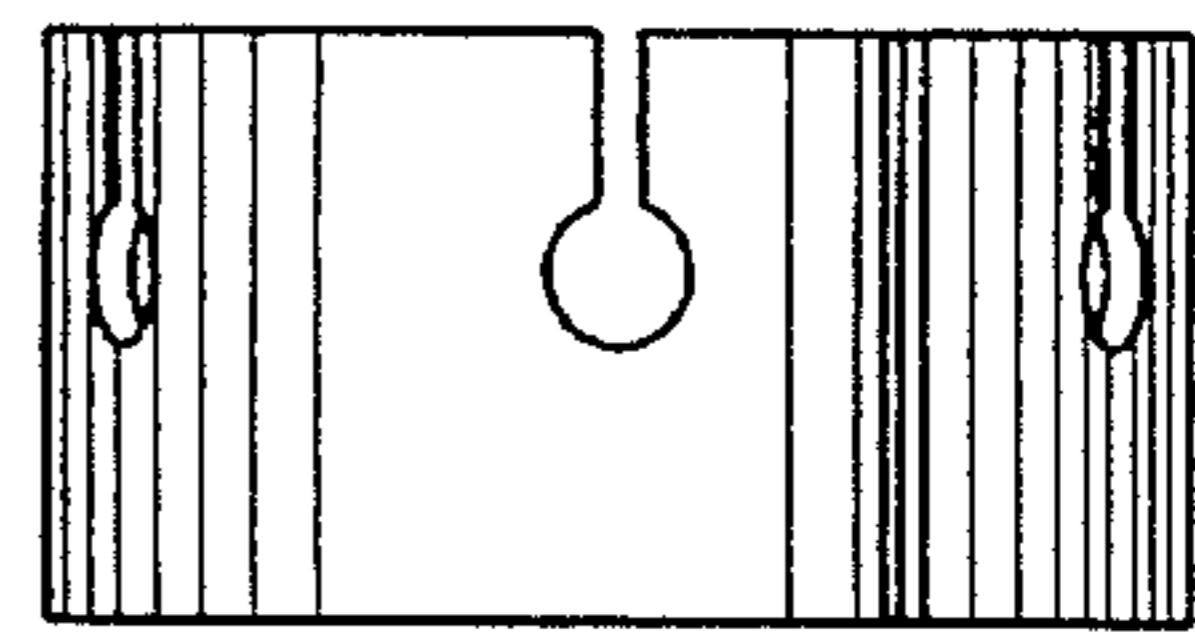

FIG. 11

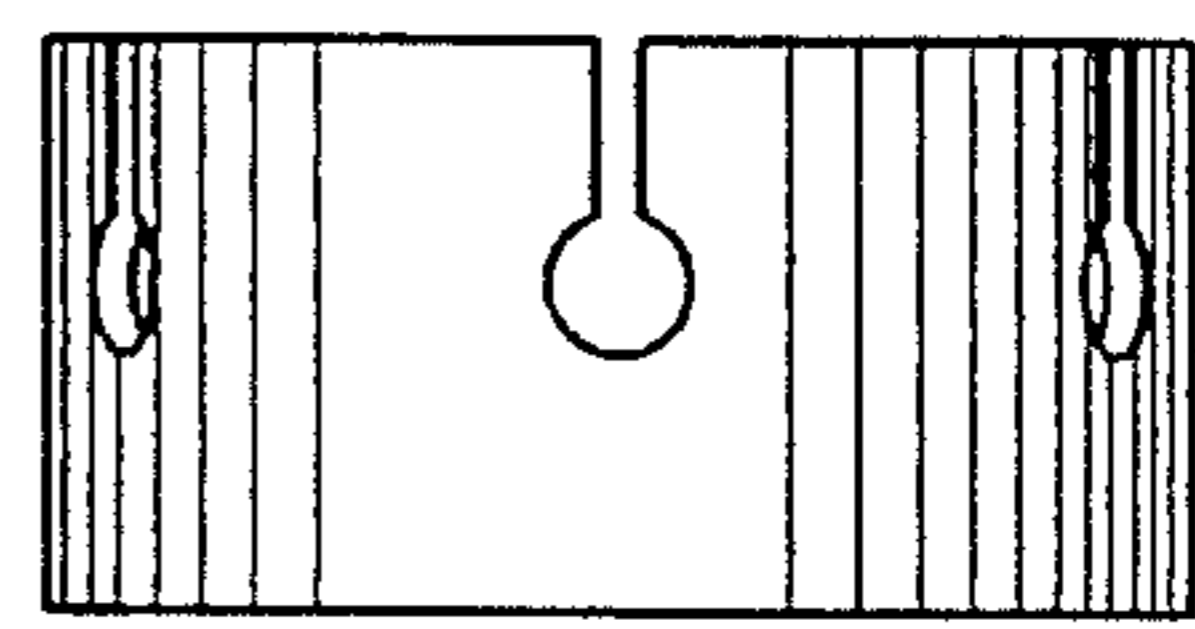

FIG. 12

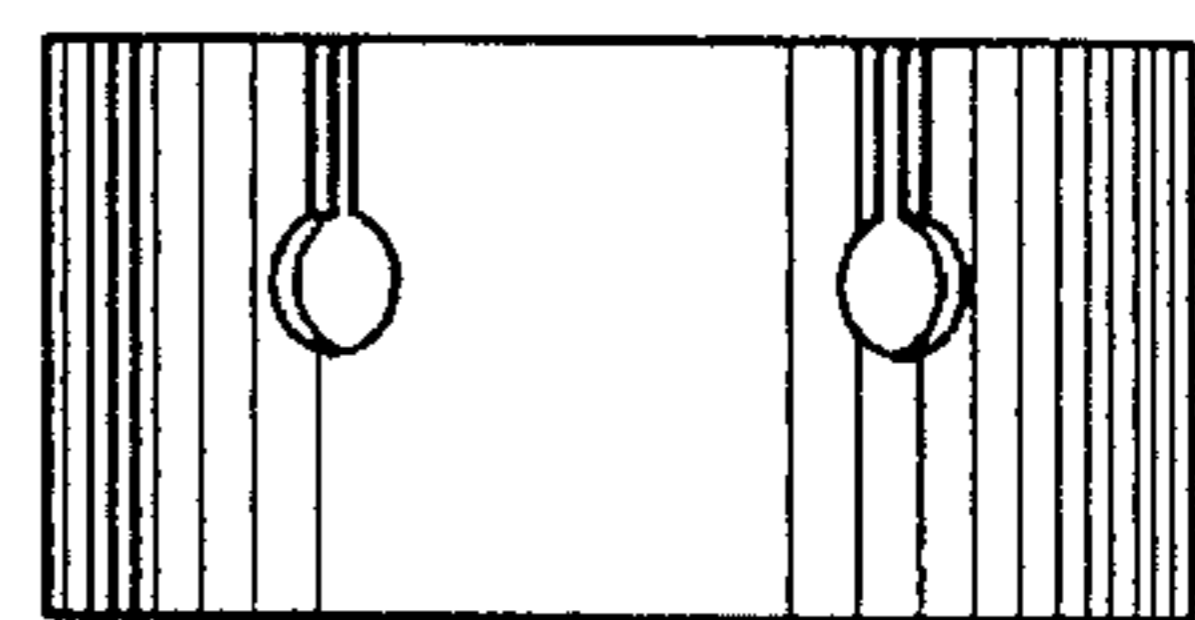

FIG. 13

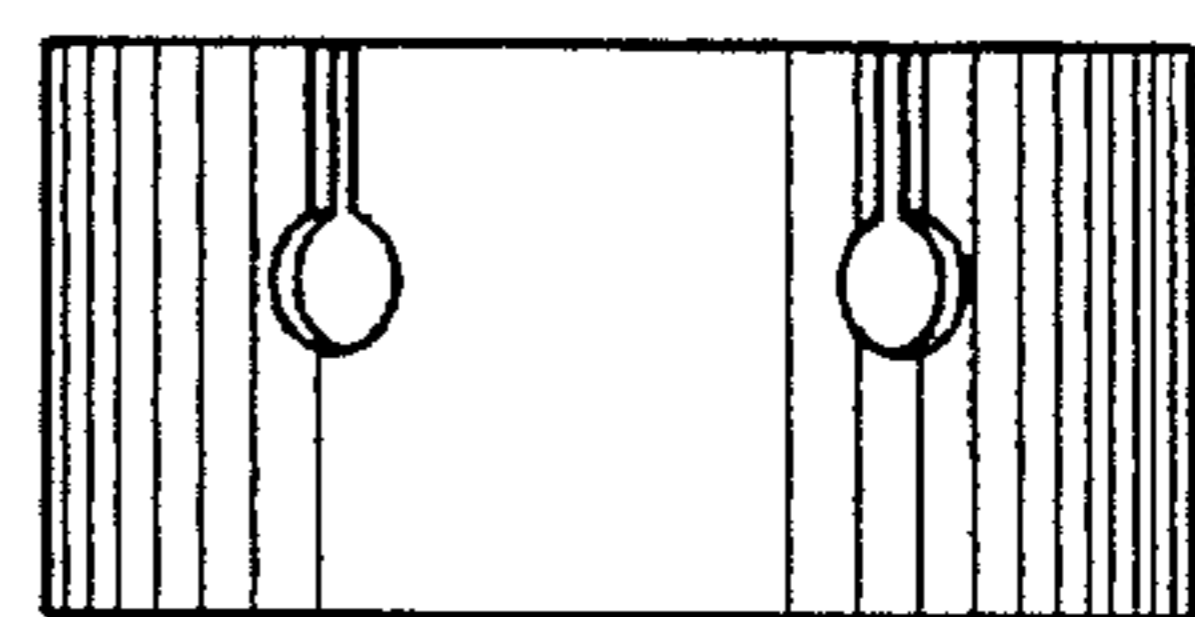

FIG. 14

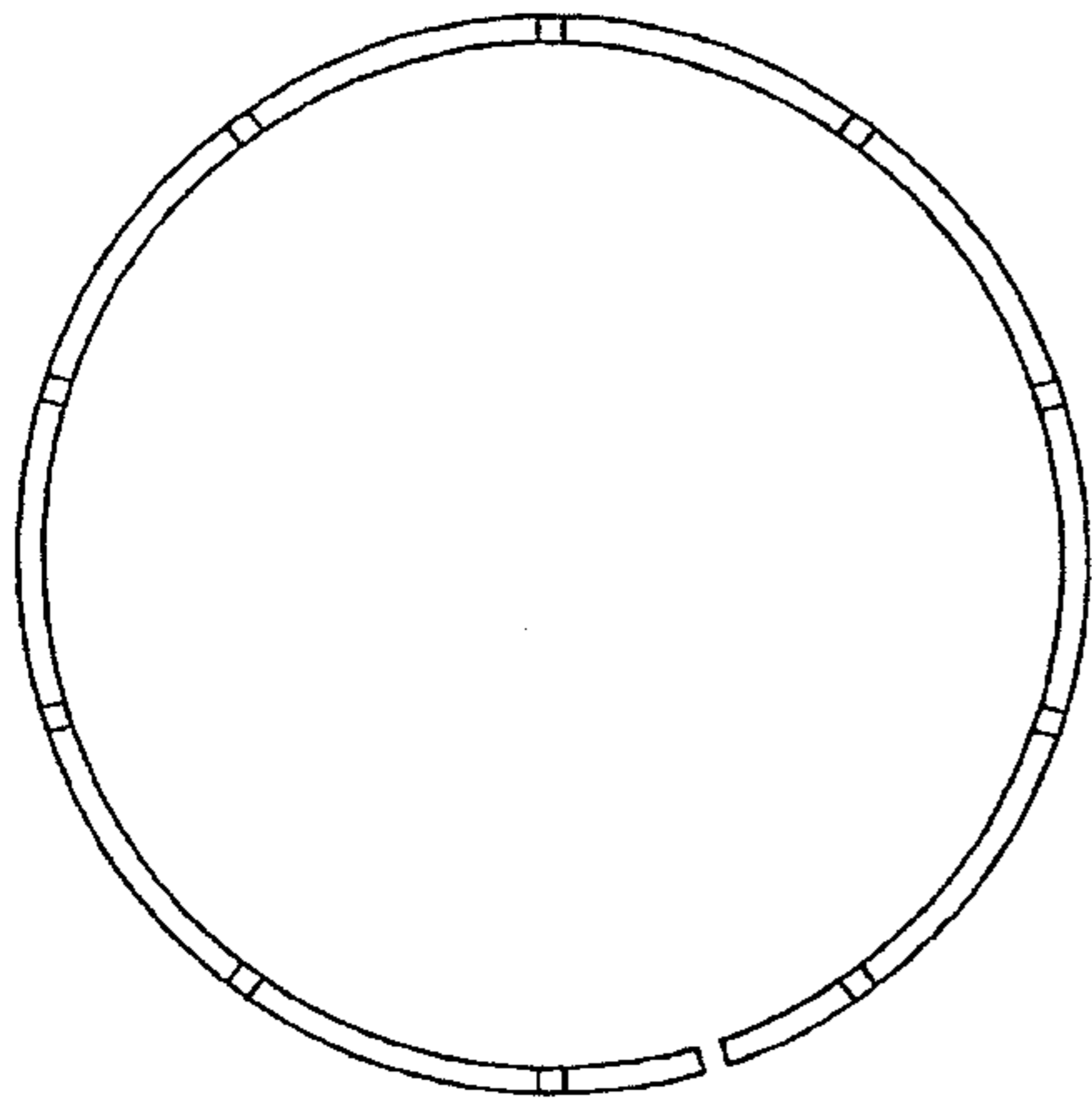

FIG. 15

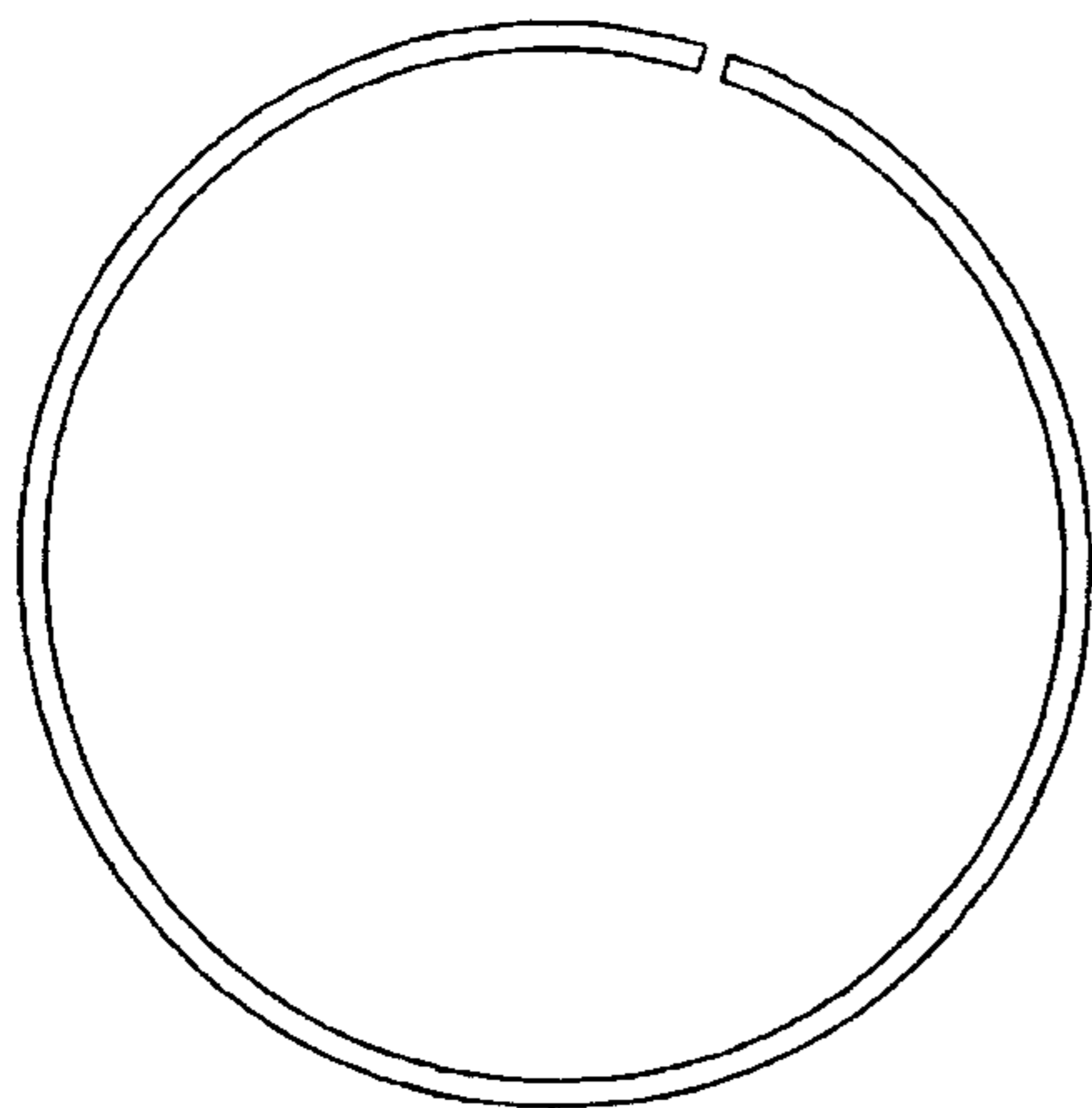

FIG. 16

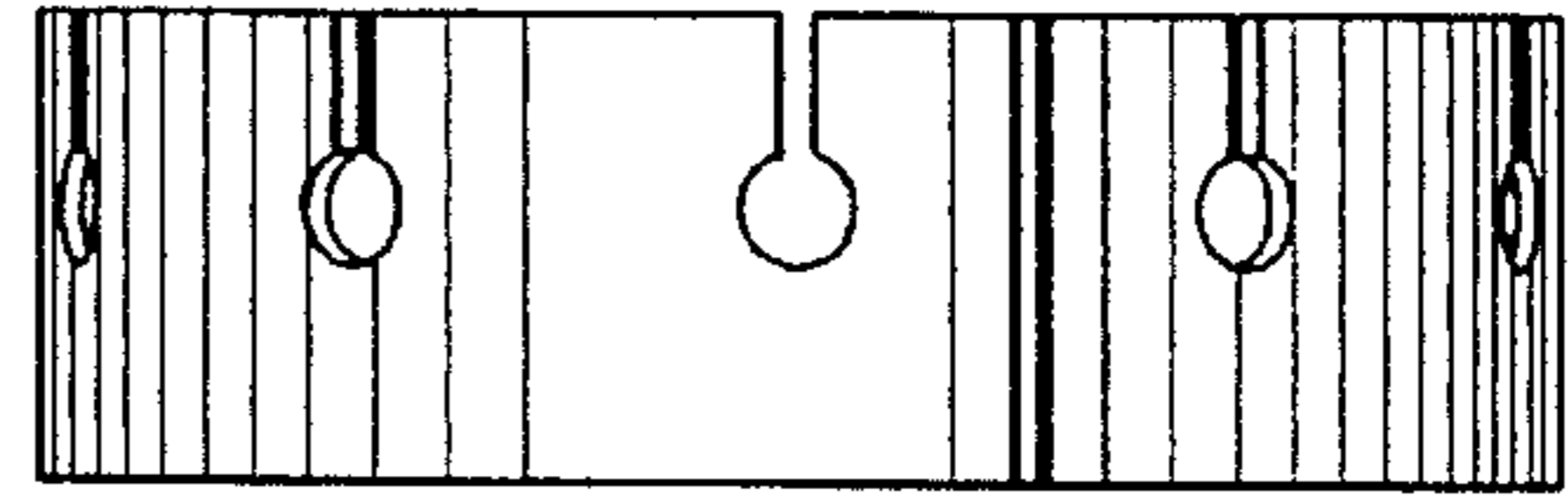

FIG. 17

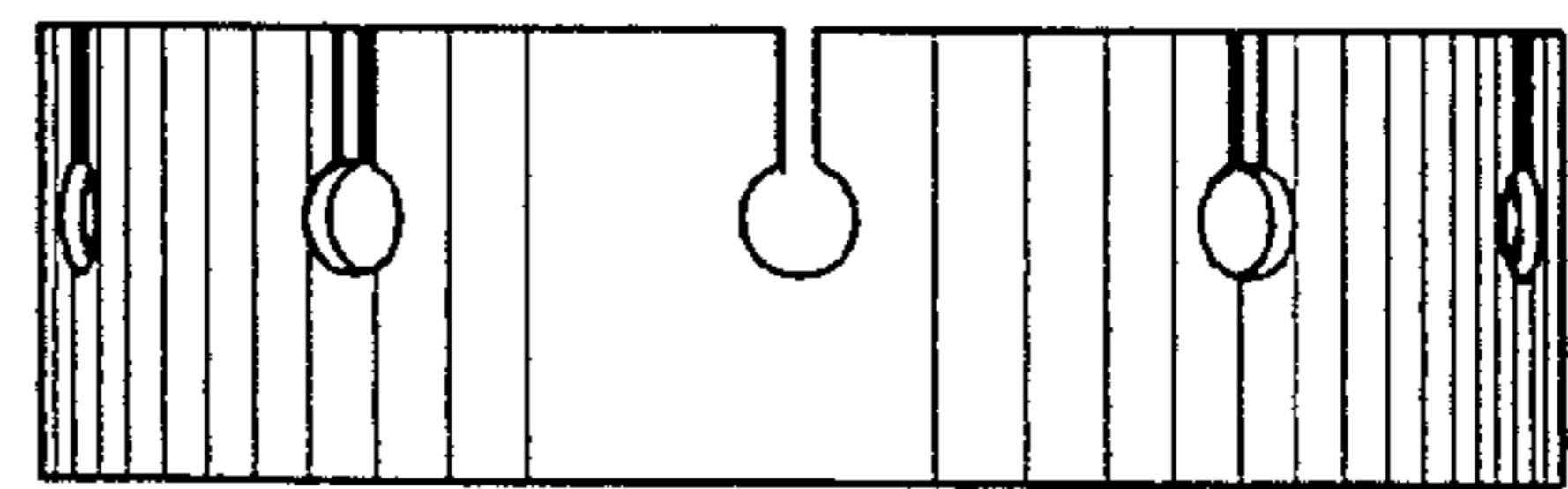

FIG. 18

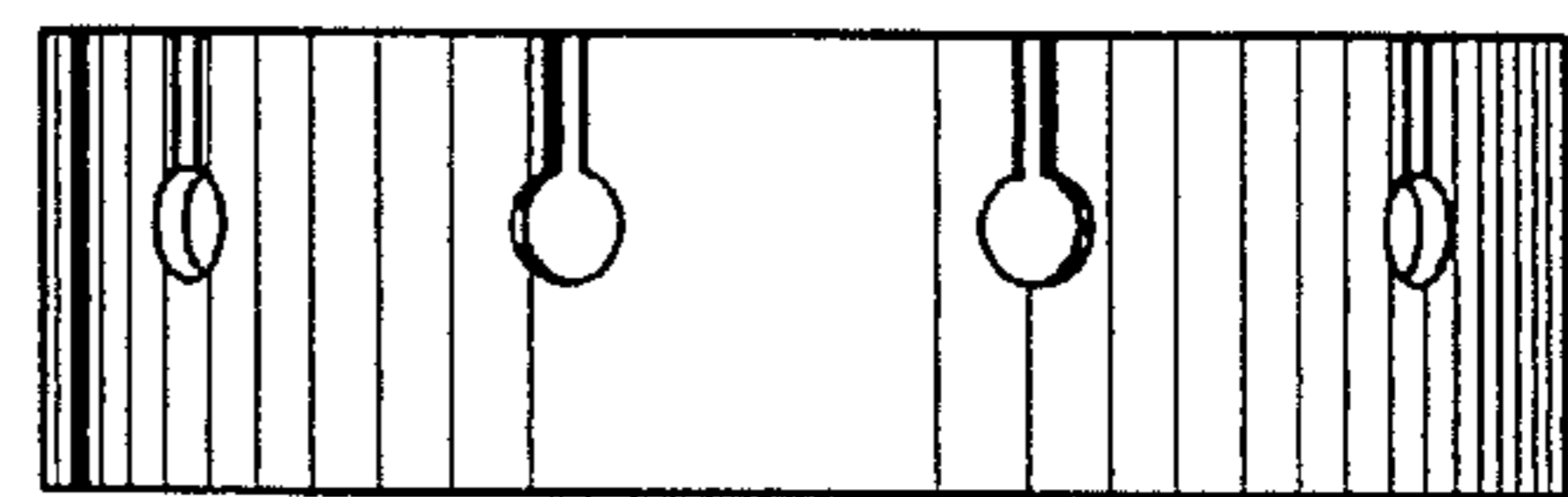

FIG. 19

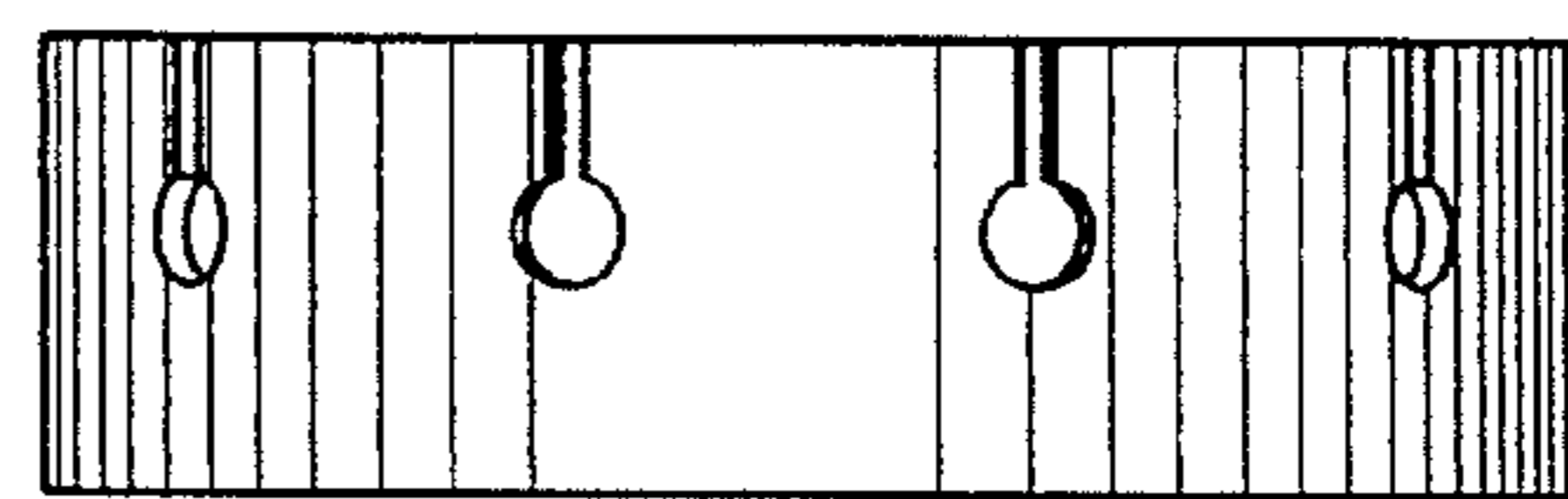

FIG. 20