



US00D377519S

United States Patent [19] Formgren

[11] Patent Number: **Des. 377,519**

[45] Date of Patent: ****Jan. 21, 1997**

[54] **TUB FOR BATHING**

[75] Inventor: **Anna-Pia K. Formgren**, Paris, France

[73] Assignee: **Jacob Delafon**, Paris, France

[**] Term: **14 Years**

[21] Appl. No.: **45,954**

[22] Filed: **Nov. 3, 1995**

[52] U.S. Cl. **D23/280.1**

[58] Field of Search D23/277, 280.1-280.4;
D24/204, 205; 4/538, 541.1-541.6, 546

[56] **References Cited**

U.S. PATENT DOCUMENTS

D. 230,021	1/1974	Primoult	D23/277
D. 252,008	9/1979	Guigues	D23/55
D. 252,704	8/1979	Read	D24/205
D. 257,058	9/1980	Laver	D24/204
D. 324,729	3/1992	Yvetot	D23/281
D. 355,963	2/1995	Formgren et al.	D23/277

OTHER PUBLICATIONS

Undated Jacob Delafon catalog ad showing an "Okinawa" tub.

Undated Jacob Delafon catalog ad showing a "vanua" tub.

Primary Examiner—Stella Reid

Assistant Examiner—Eric Watterson

Attorney, Agent, or Firm—Quarles & Brady

[57] **CLAIM**

The ornamental design for a tub for bathing, as shown and described.

DESCRIPTION

FIG. 1 is a right, top, front perspective view of a tub for bathing embodying my new design;

FIG. 2 is a top plan view thereof;

FIG. 3 is a front elevational view thereof, the rear elevational view being a mirror image of the front side shown;

FIG. 4 is a left side elevational view thereof;

FIG. 5 is a right side elevational view thereof;

FIG. 6 is a cross-sectional view taken along line 6—6 of FIG. 2;

FIG. 7 is a cross-sectional view taken along line 7—7 of FIG. 2;

FIG. 8 is a top plan view of a second embodiment, the left side elevational view, the right side elevational view, and the shorter cross-sectional view of the second embodiment being essentially identical to those shown in the first embodiment;

FIG. 9 is a front elevational view thereof; and,

FIG. 10 is a cross-sectional view taken along line 10—10 of FIG. 8.

The broken line representations of a mounting island in FIG. 1 and of holes in FIGS. 2, 5, and 8 are for purposes of illustration only, and form no part of the claimed design.

1 Claim, 3 Drawing Sheets

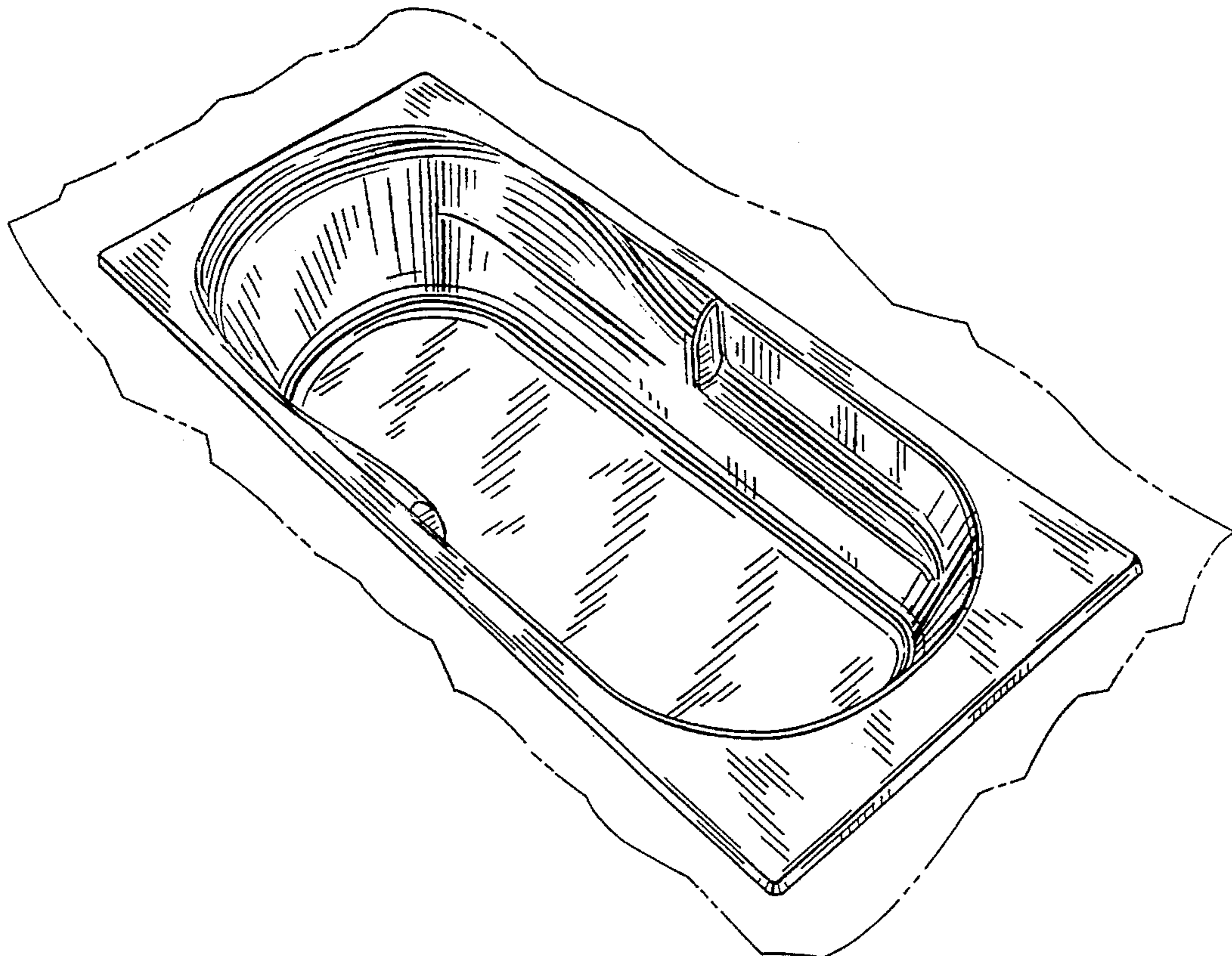

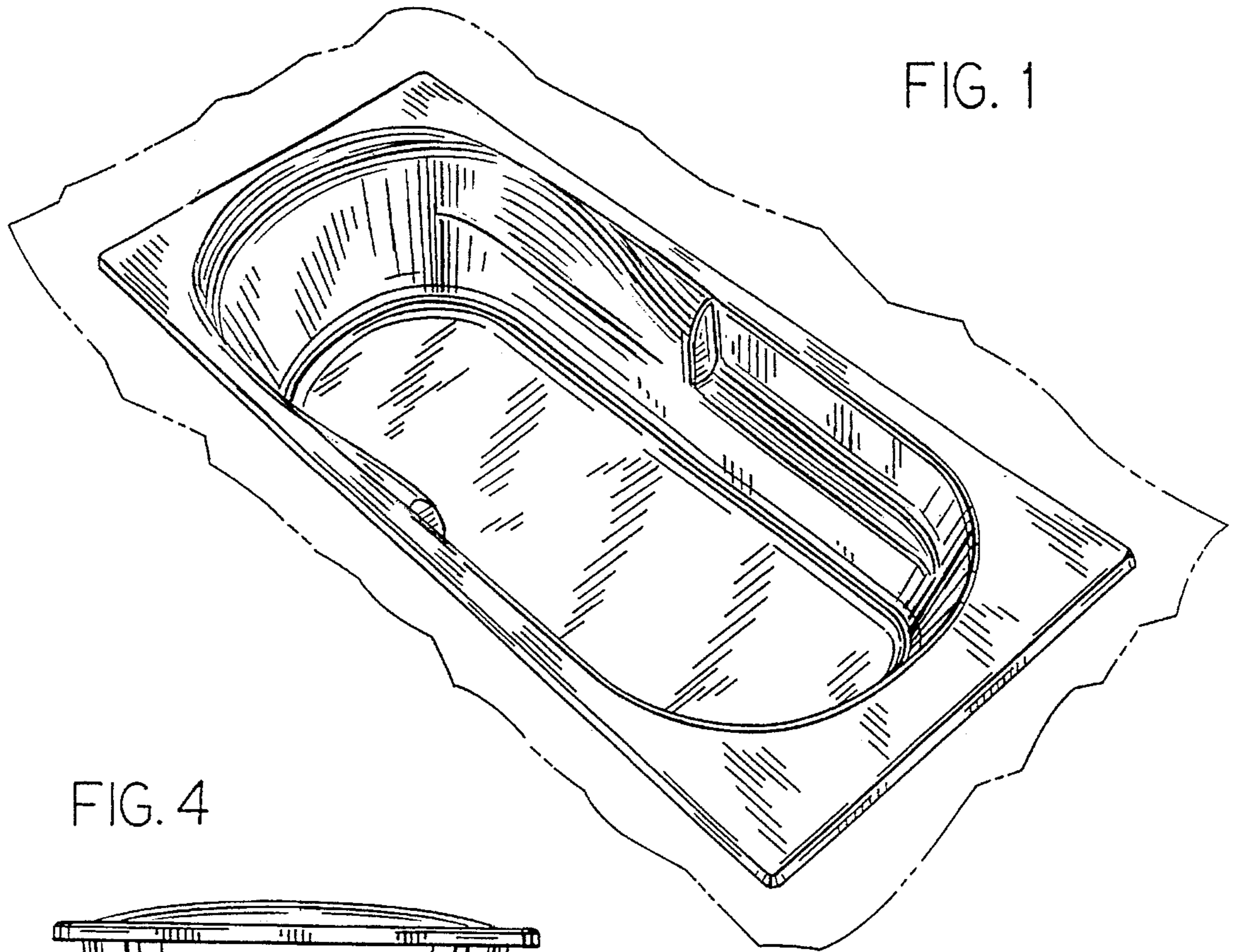

FIG. 4

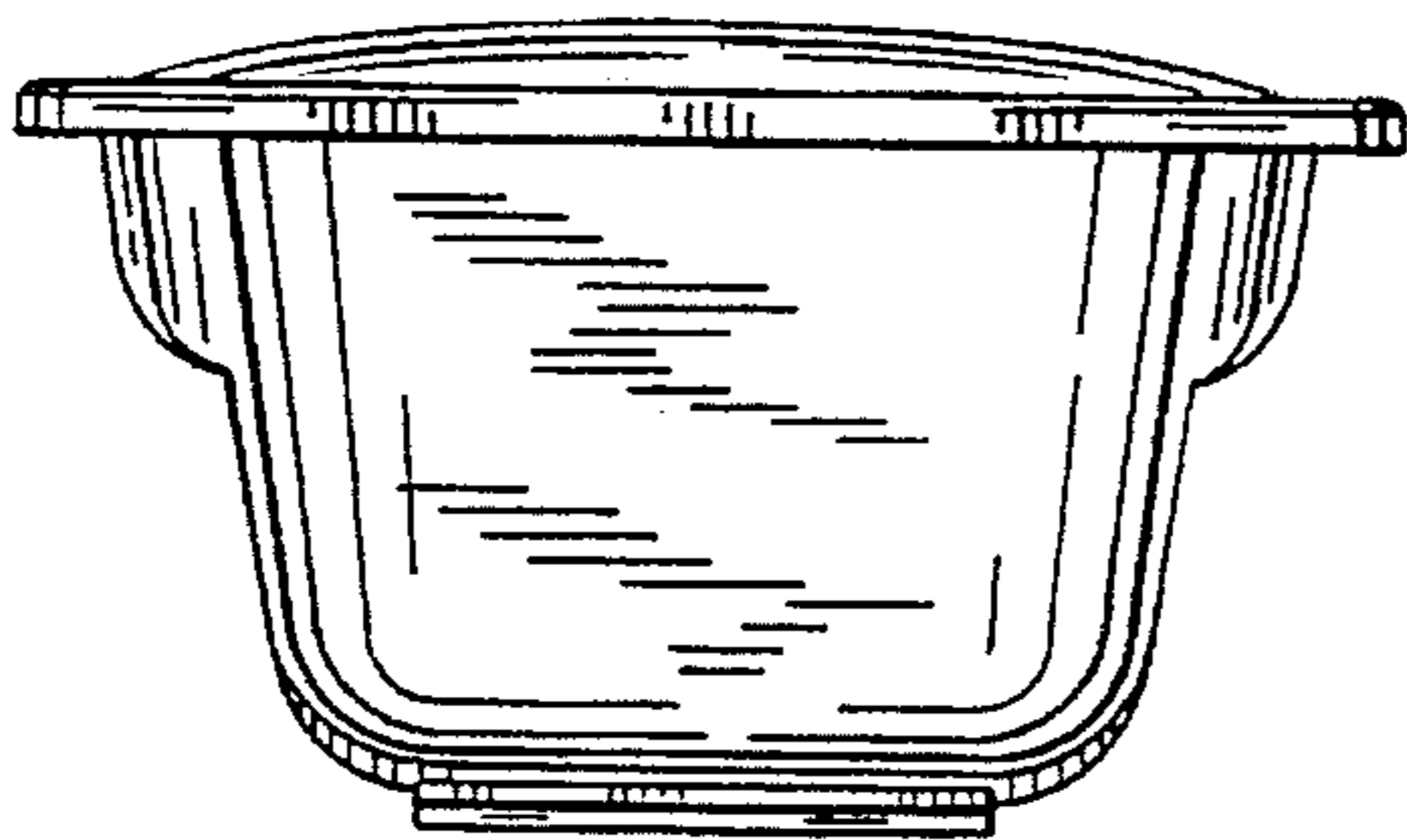

FIG. 2

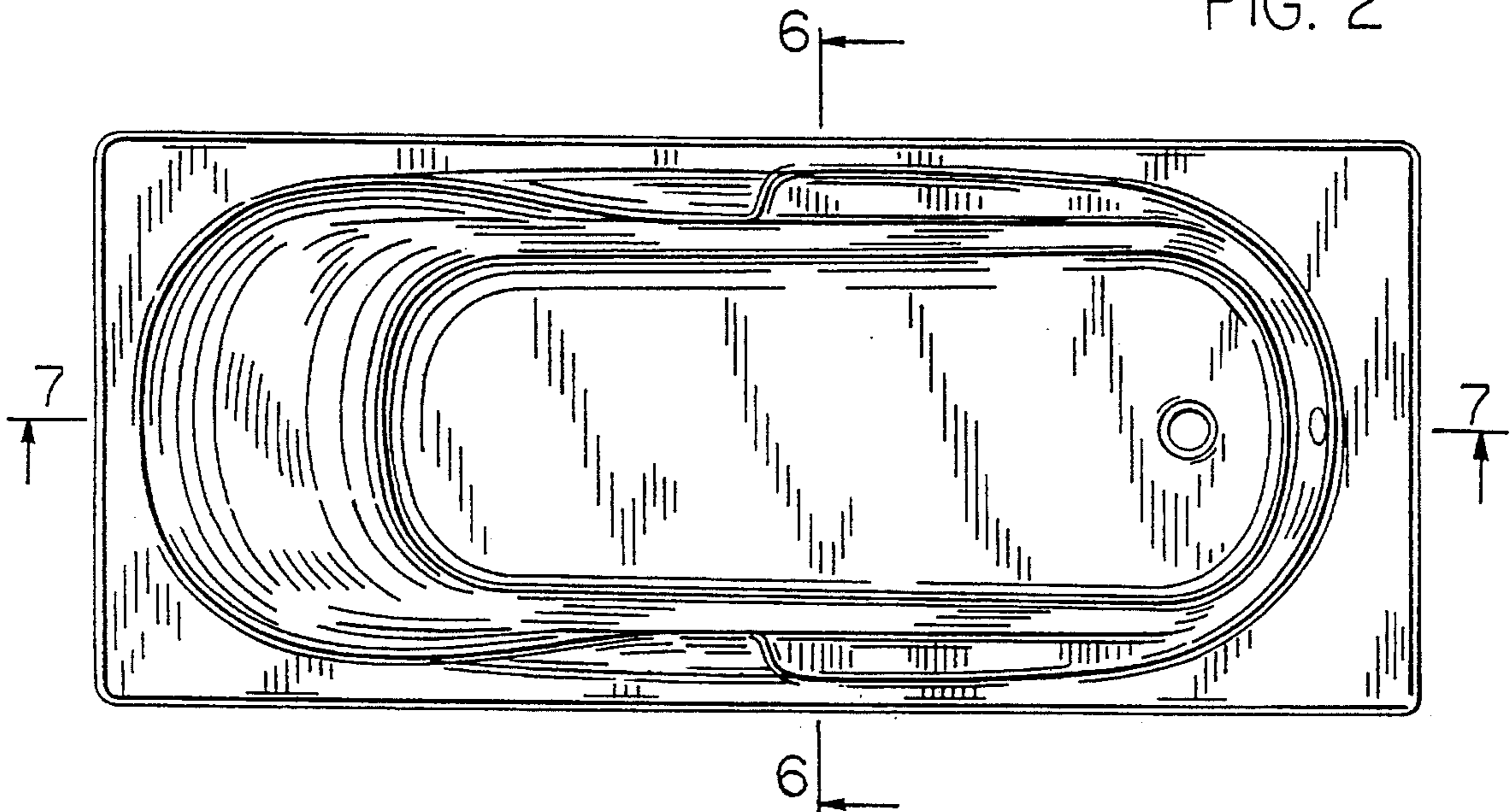

FIG. 3

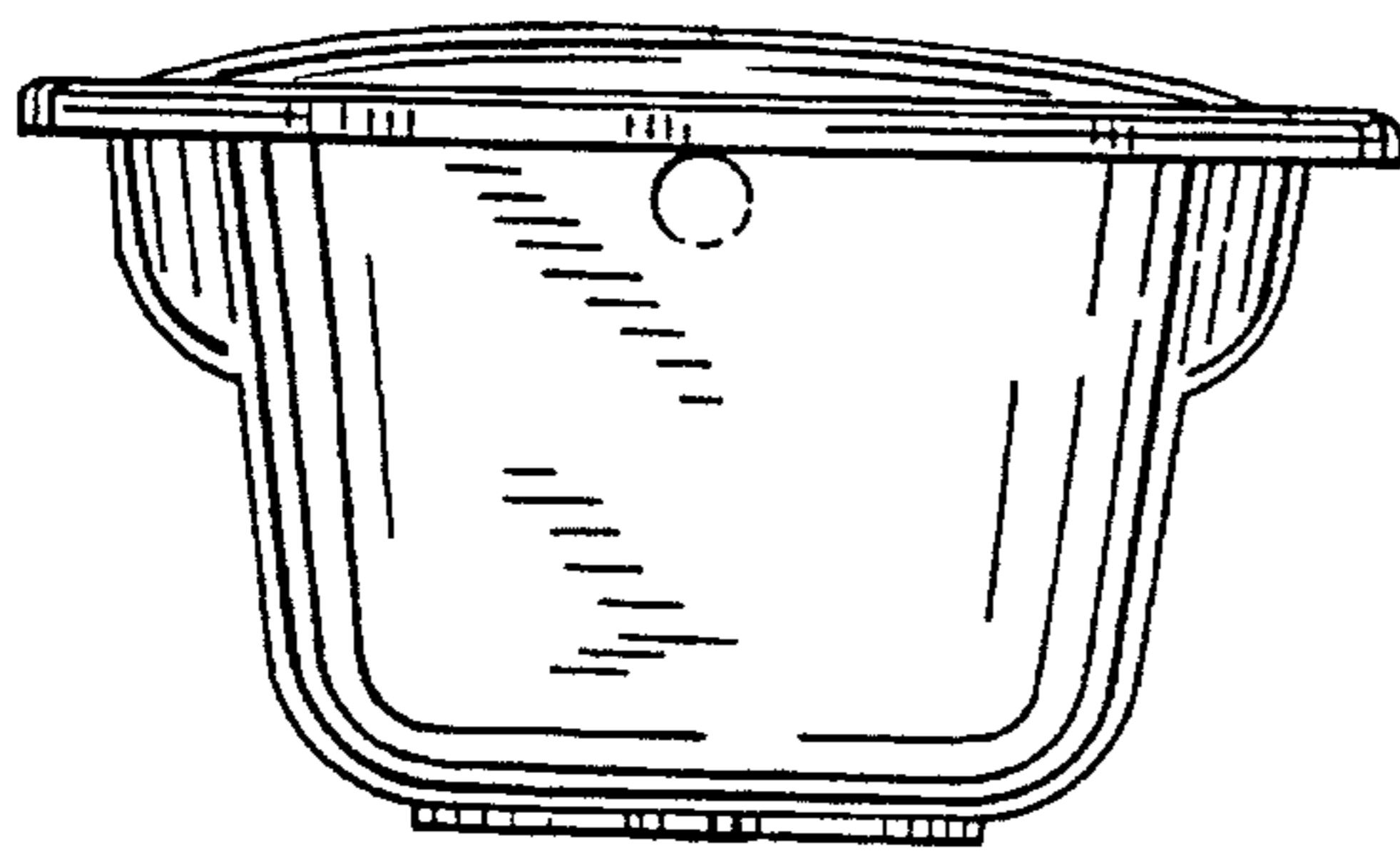
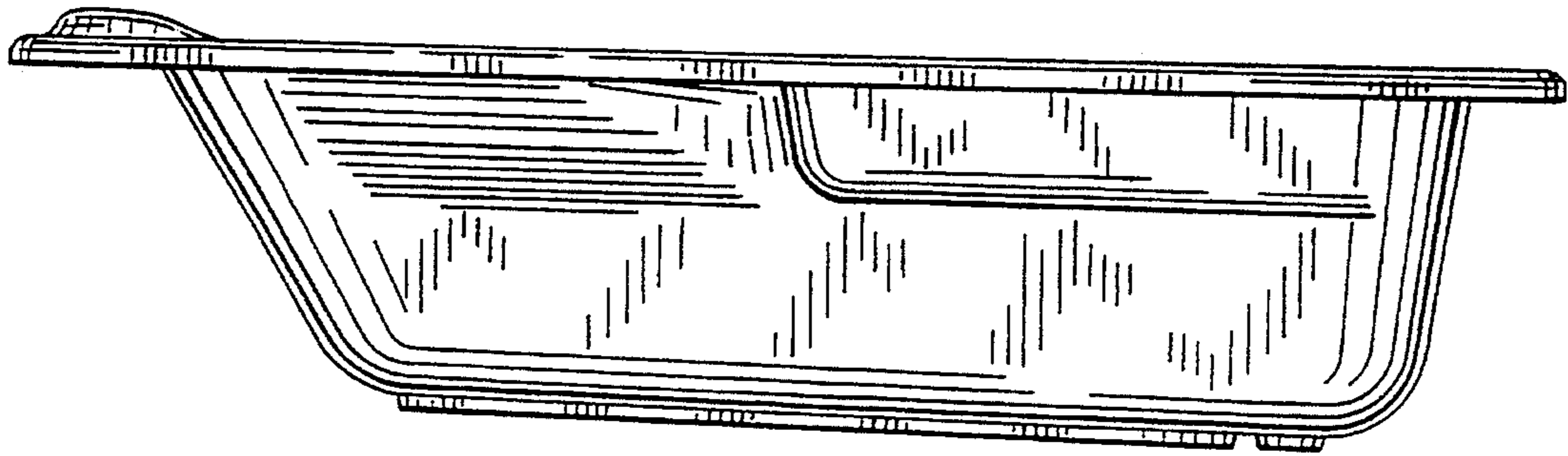

FIG. 5

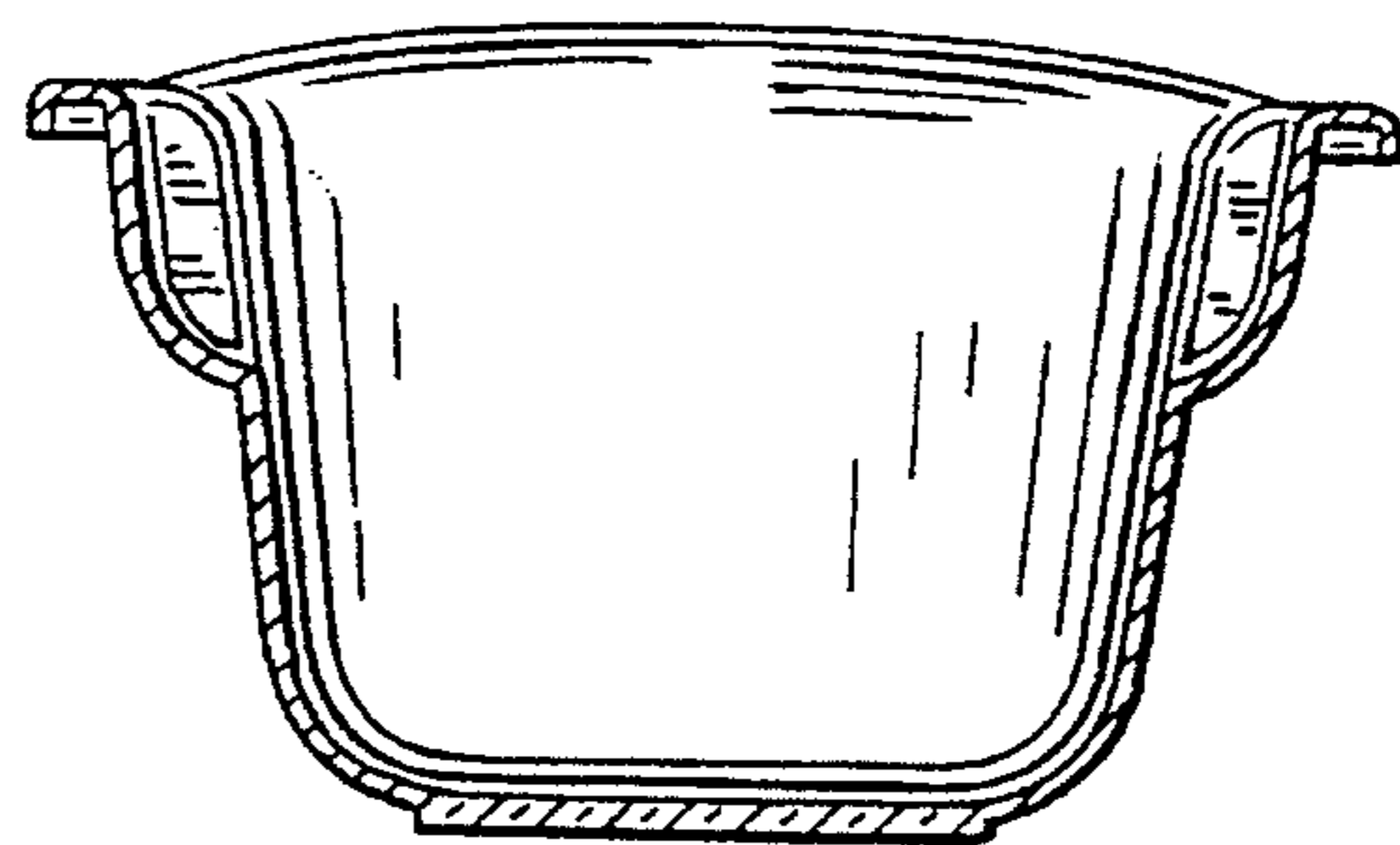

FIG. 6

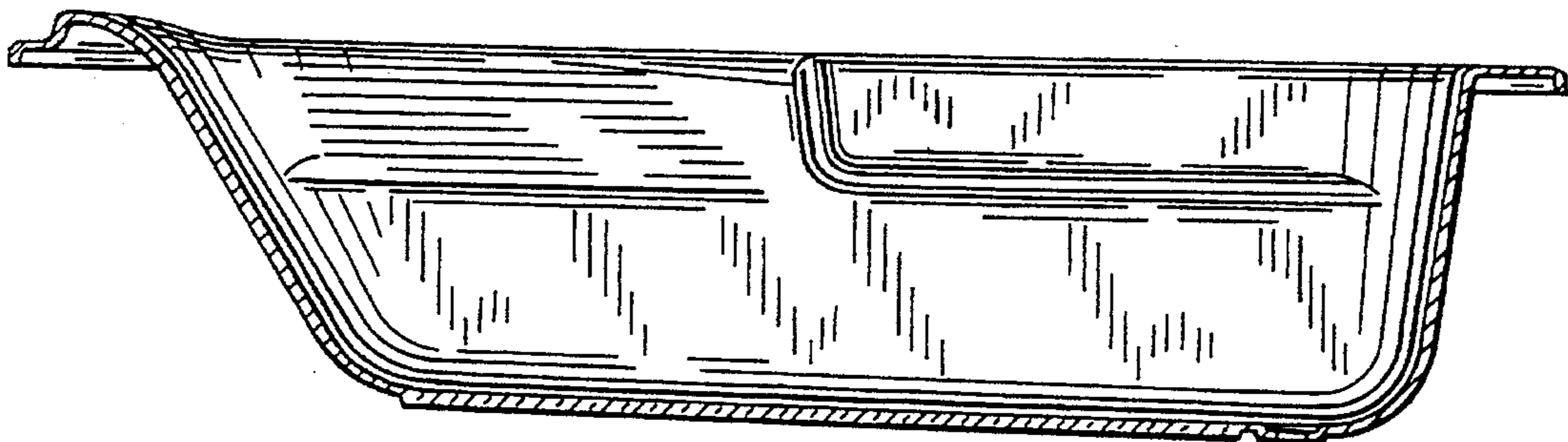

FIG. 7

FIG. 8

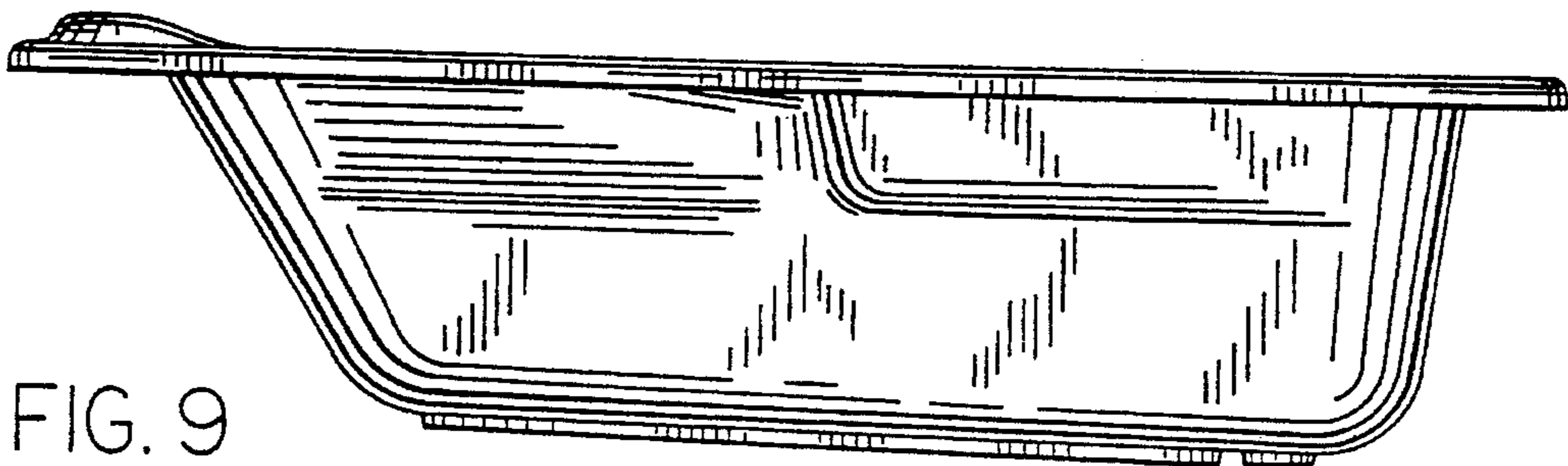
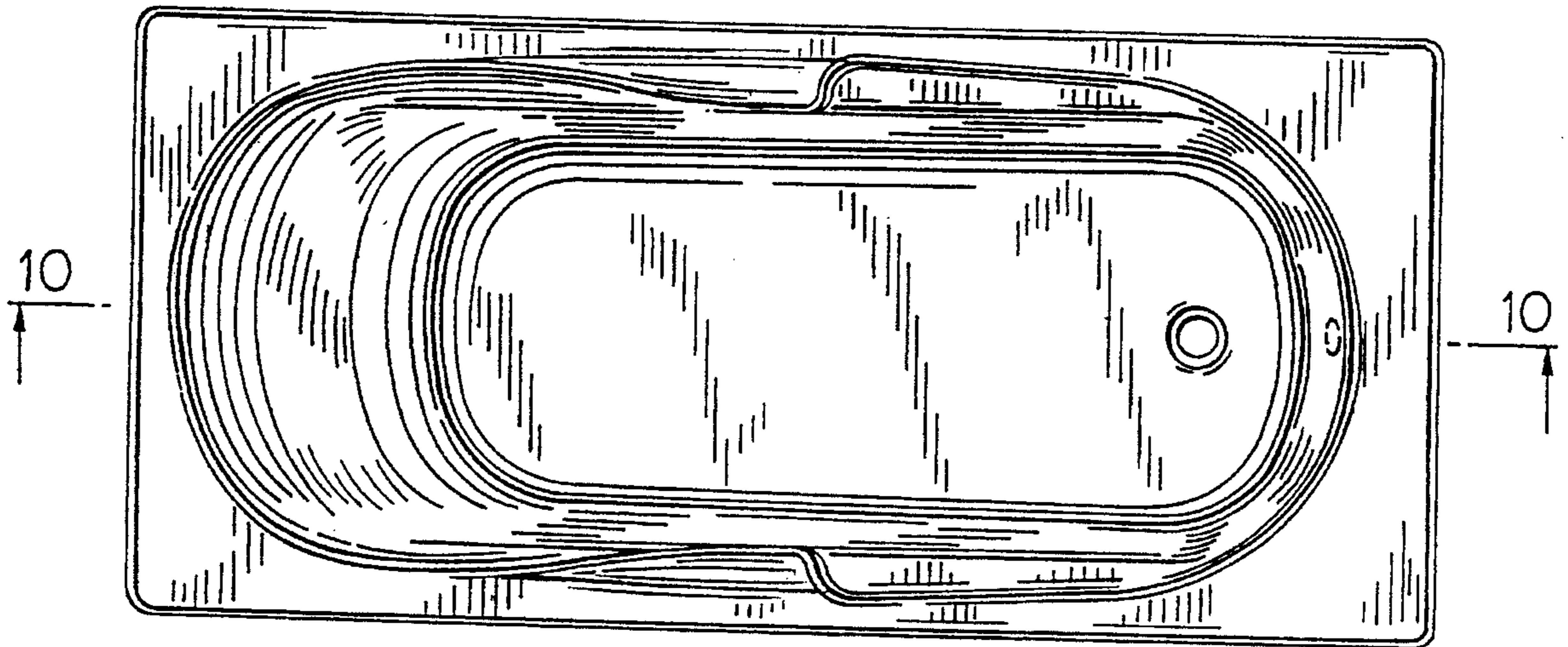

FIG. 9

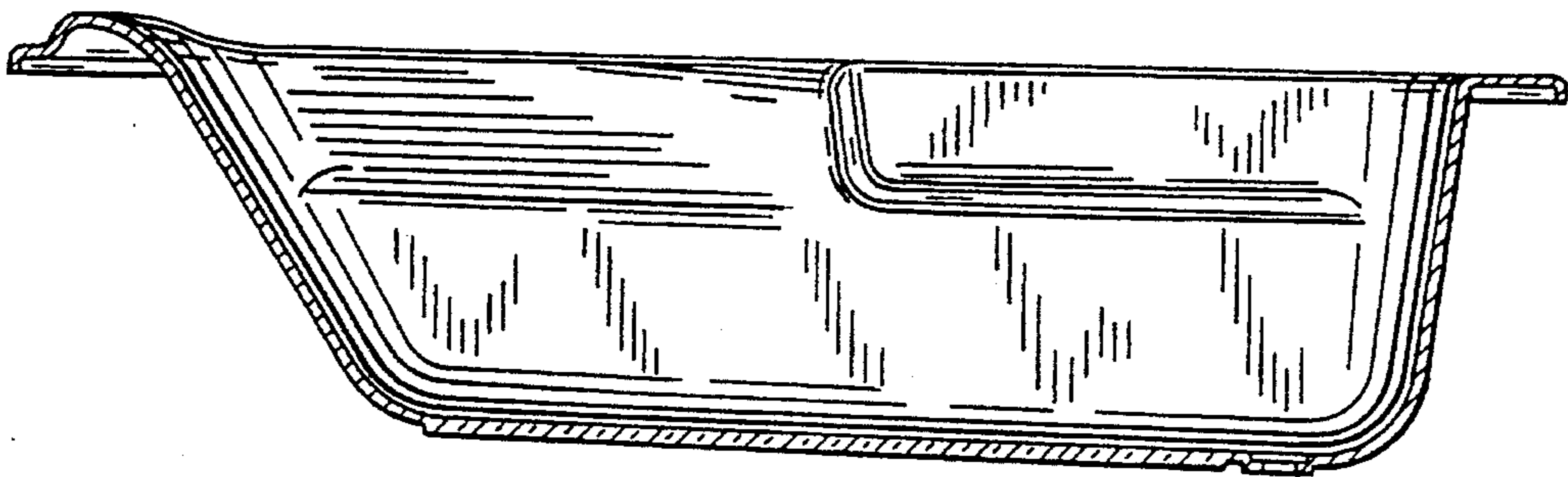

FIG. 10