



US00D377388S

United States Patent [19]

Weber et al.

[11] Patent Number: **Des. 377,388**

[45] Date of Patent: ****Jan. 14, 1997**

[54] **WATER PURIFIER**

D. 351,014 9/1994 Hansen D23/209
4,504,387 3/1985 LeMire et al. 210/416.2

[75] Inventors: **Jeffrey A. Weber**, Minneapolis; **David J. Emmons**, Plymouth, both of Minn.

Primary Examiner—A. Hugo Word
Assistant Examiner—Robin V. Taylor
Attorney, Agent, or Firm—Merchant, Gould, Smith, Edell, Welter & Schmidt

[73] Assignee: **Recovery Engineering, Inc.**, Minneapolis, Minn.

[**] Term: **14 Years**

[57] CLAIM

The ornamental design for a water purifier, as shown.

[21] Appl. No.: **41,091**

DESCRIPTION

[22] Filed: **Jul. 5, 1995**

[52] U.S. Cl. **D23/207**

[58] Field of Search D23/200, 207-210;
D7/312, 313, 322; 210/167, 416.1, 416.2,
493.4, 497.1, 459, 460

FIG. 1 is a perspective view of a water purifier showing our new design;

FIG. 2 is a front elevational view thereof;

FIG. 3 is a rear elevational view thereof;

FIG. 4 is a left side elevational view thereof;

FIG. 5 is a right side elevational view thereof;

FIG. 6 is a top plan view thereof; and,

FIG. 7 is a bottom plan view thereof.

[56] References Cited

U.S. PATENT DOCUMENTS

D. 49,789 10/1916 Barnes D23/209
D. 275,310 8/1984 Stanley D23/209

1 Claim, 6 Drawing Sheets

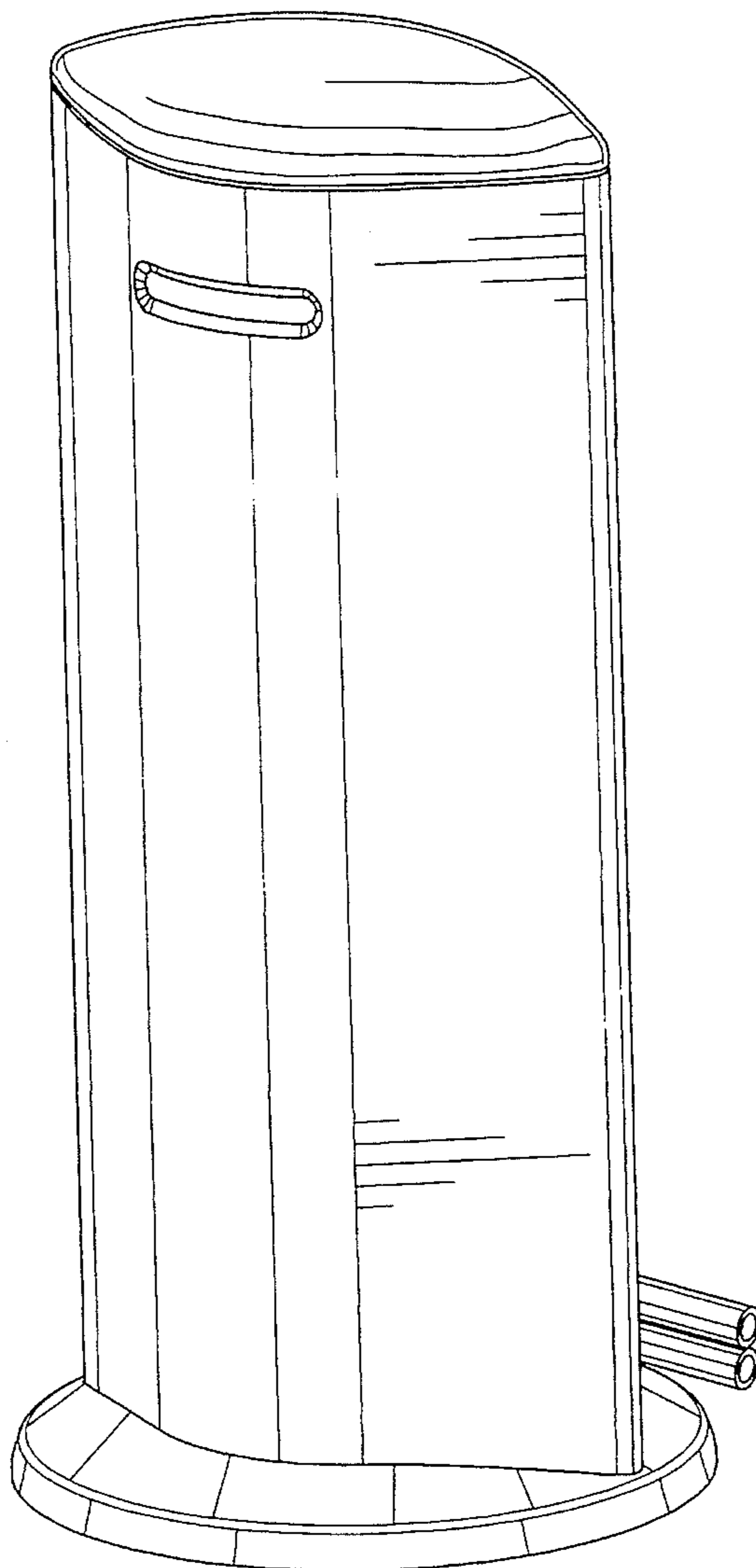

FIG. 1

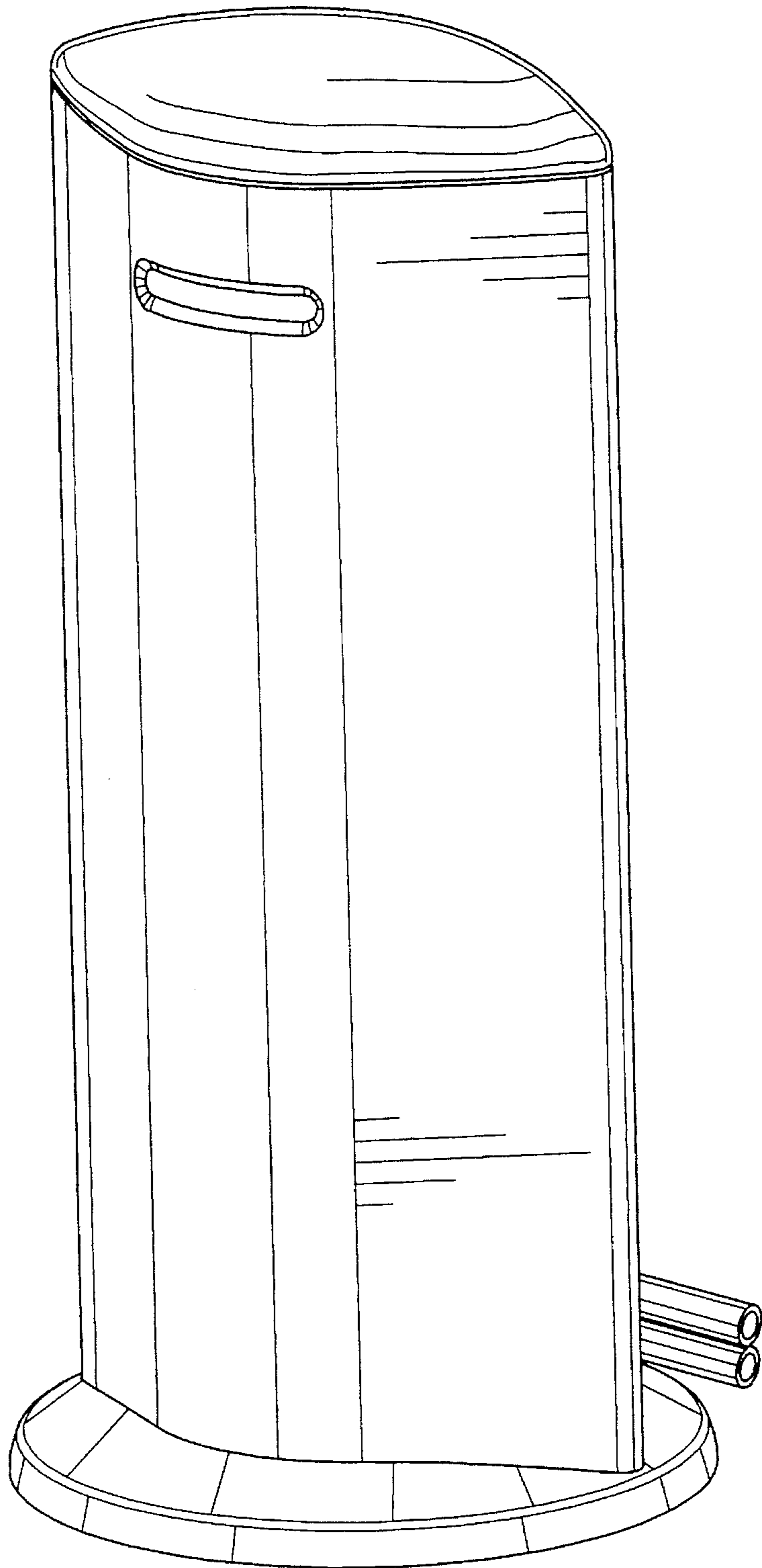

FIG. 2

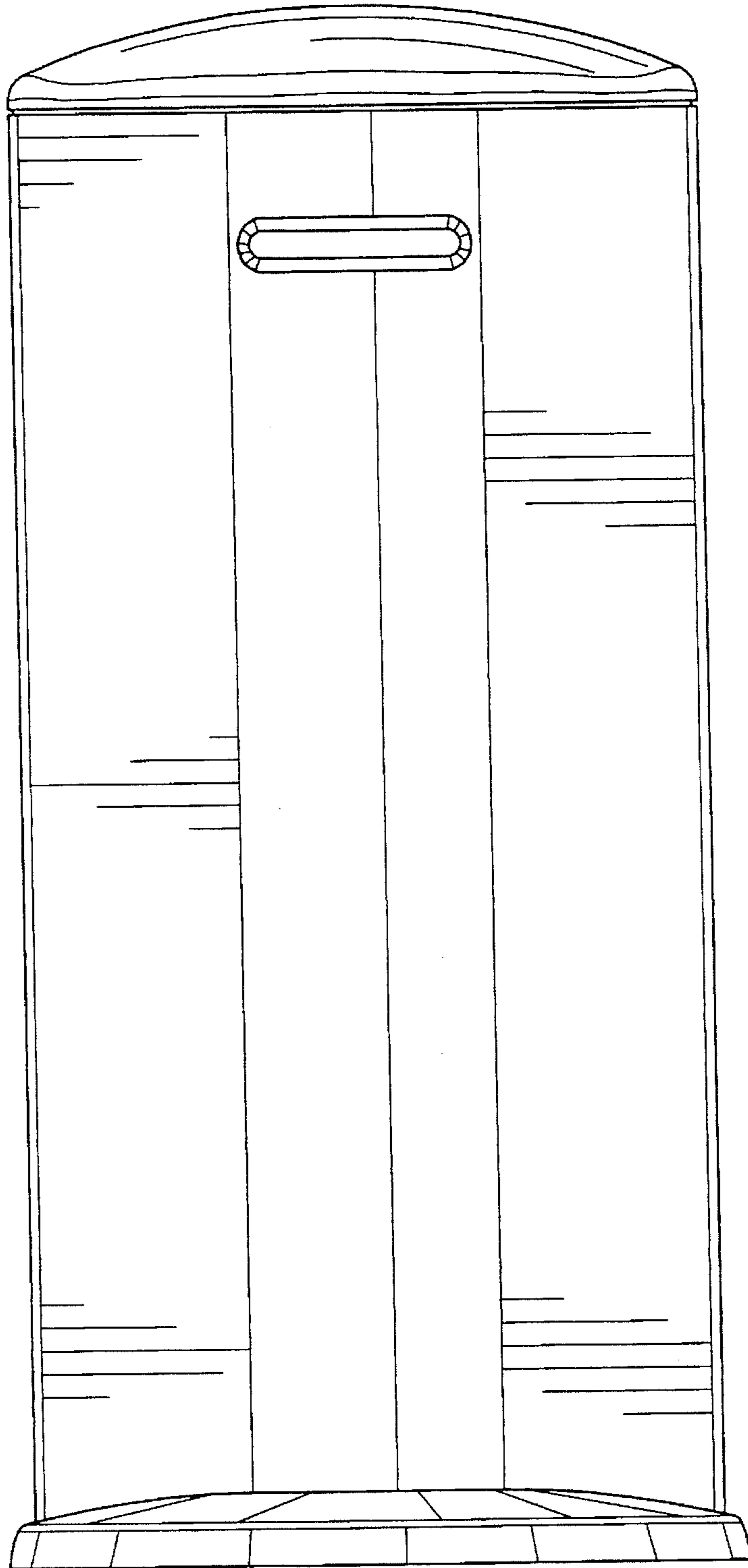

FIG. 3

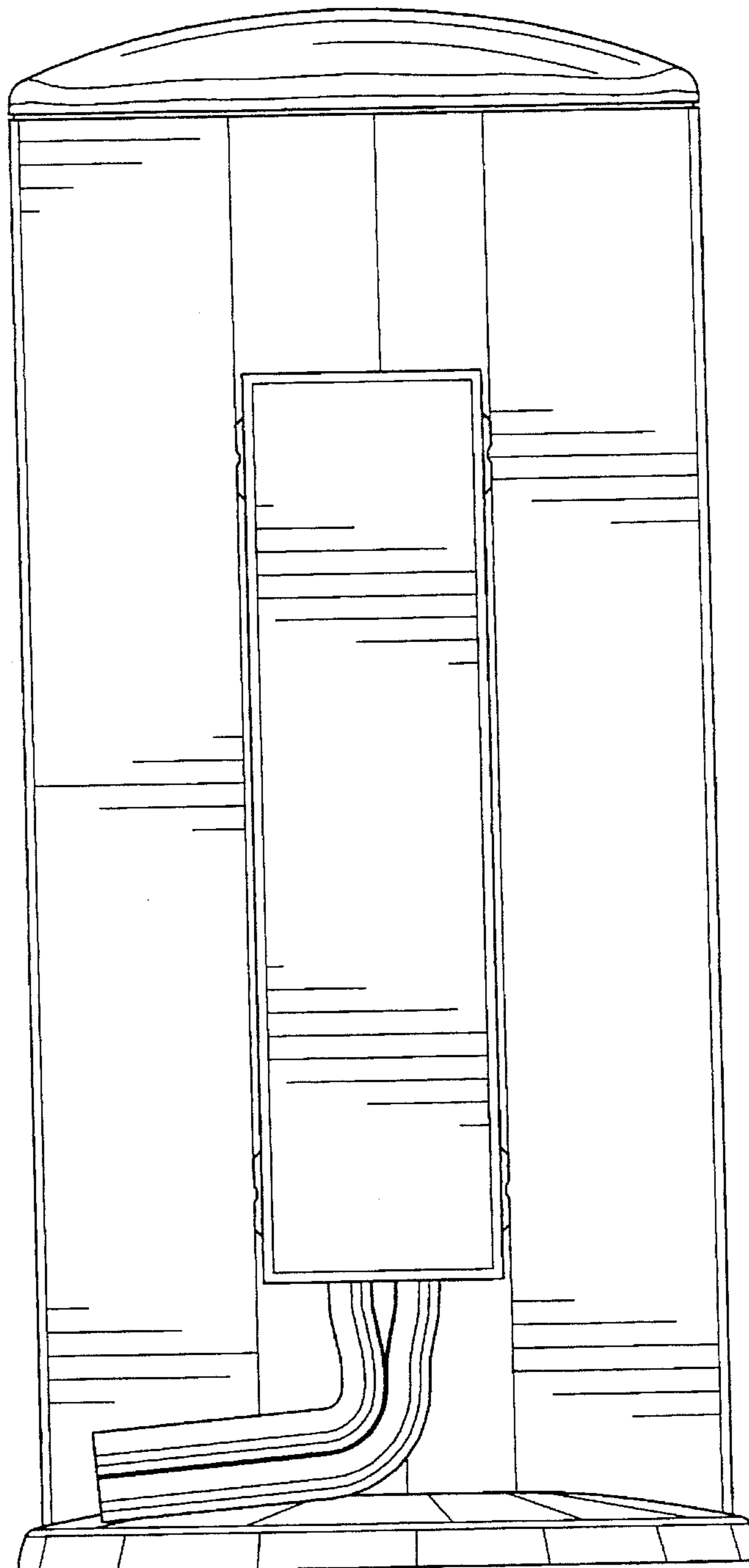

FIG. 4

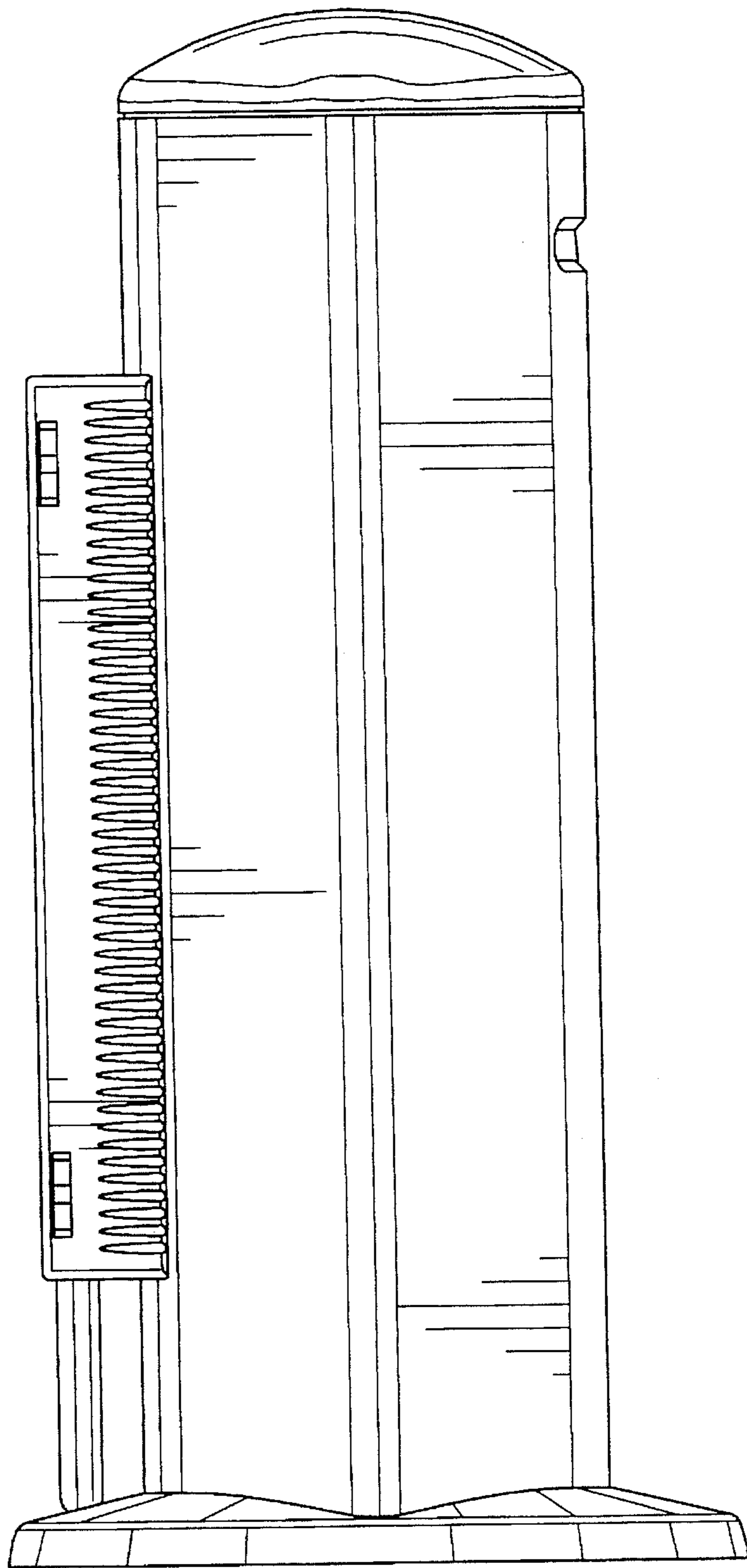

FIG. 5

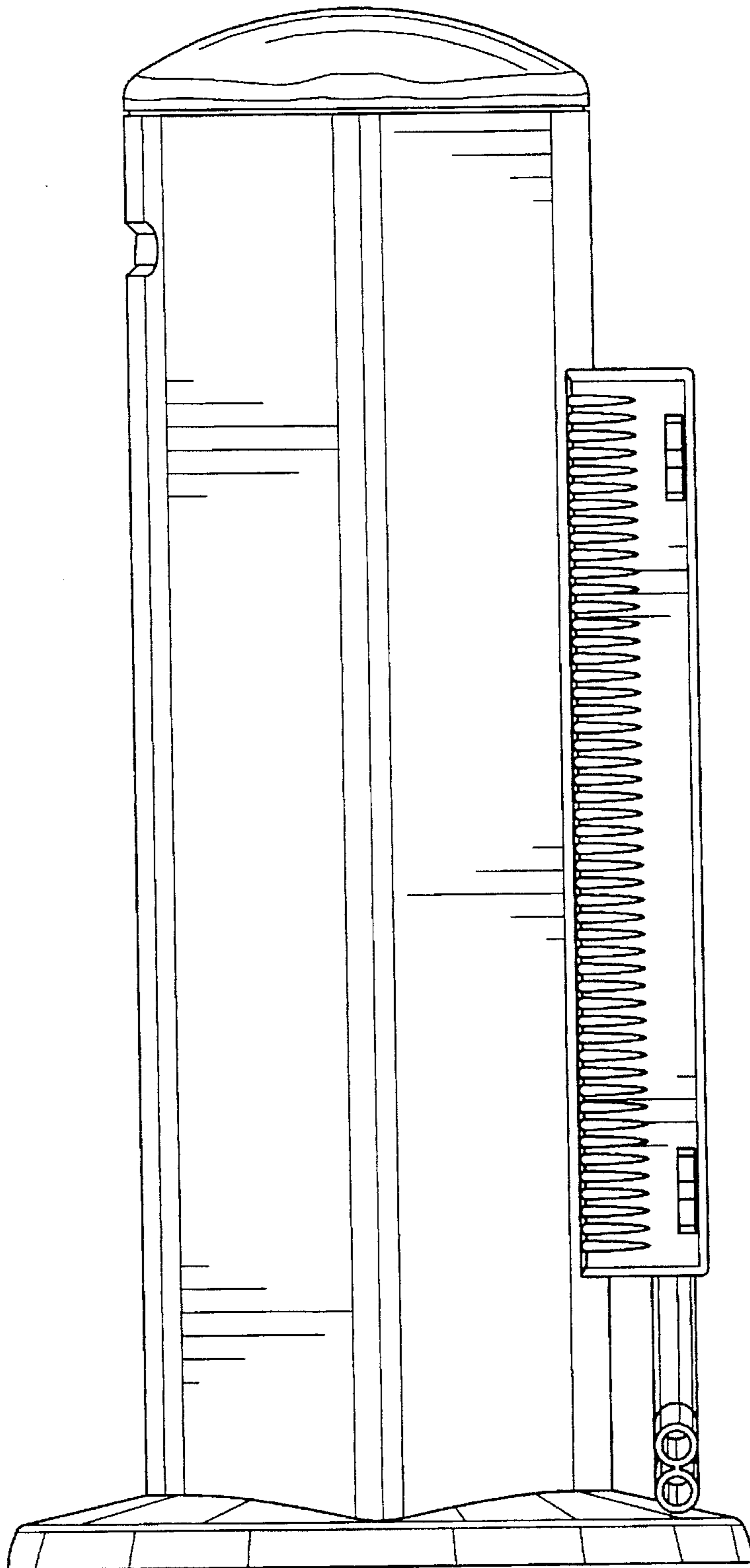

FIG. 6

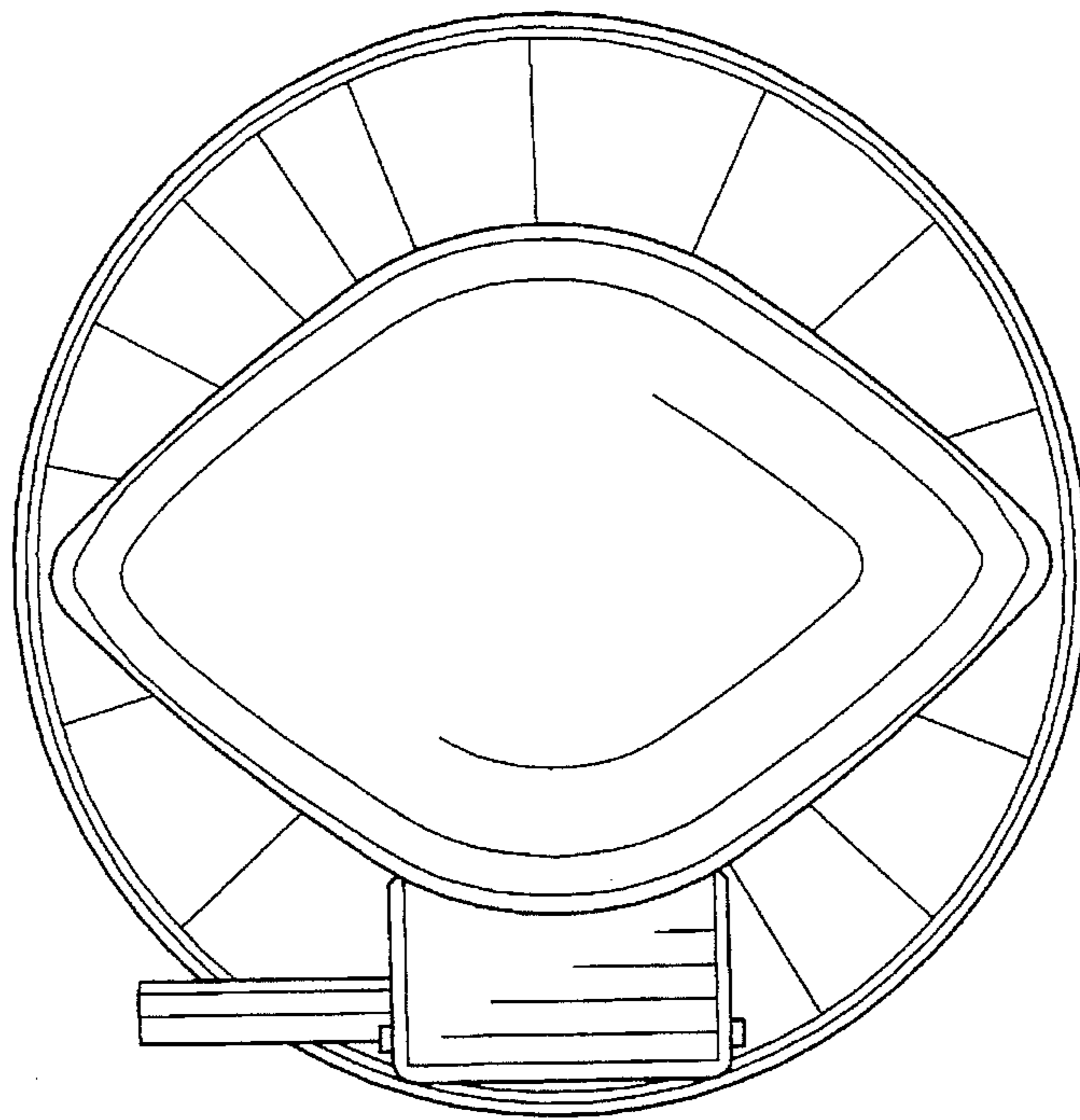

FIG. 7

