



US00D377349S

United States Patent [19]
Renk

[11] **Patent Number: Des. 377,349**
[45] **Date of Patent: **Jan. 14, 1997**

- [54] **COMBINED TELEVISION, COMPACT DISC PLAYER AND INTEGRAL REMOTE CONTROL**
- [75] Inventor: **Thomas E. Renk**, Indianapolis, Ind.
- [73] Assignee: **Thomson Consumer Electronics, Inc.**, Indianapolis, Ind.
- [**] Term: **14 Years**
- [21] Appl. No.: **43,032**
- [22] Filed: **Aug. 23, 1995**
- [52] U.S. Cl. **D14/129; D14/218; D14/221**
- [58] **Field of Search** **D14/113, 124-134, D14/218, 221, 239, 299; 312/7.2; 348/825, 836, 838**

[56] **References Cited**

U.S. PATENT DOCUMENTS

D. 153,012	3/1949	Palma	D14/159
D. 160,538	10/1950	Reynolds	D14/195
D. 339,137	9/1993	Takeda	D14/218
D. 342,945	1/1994	Park	D14/129
D. 346,152	4/1994	Zaugg	D14/218 X
D. 352,717	11/1994	Usami et al.	D14/218
D. 357,469	4/1995	Baek	D14/126 X
D. 359,730	6/1995	Kazama	D14/126
4,755,883	7/1988	Uehira	358/335

Primary Examiner—Terry A. Wallace
Assistant Examiner—Richelle Shelton
Attorney, Agent, or Firm—Woodard, Emhardt, Naughton Moriarty & McNett

[57] **CLAIM**

The ornamental design for a combined television, compact disc player and integral remote control, as shown and described.

DESCRIPTION

FIG. 1 is a front elevational view showing my new design of a combined television, compact disc player and integral remote control;

FIG. 2 is a top plan view thereof;

FIG. 3 is a left side elevational view thereof, the right side being a mirror image;

FIG. 4 is a rear elevational view thereof;

FIG. 5 is a bottom plan view thereof;

FIG. 6 is a reduced right side, front perspective view of the combined television, compact disc player and integral remote control;

FIG. 7 is a right side, front perspective view thereof with speakers and remote control in an alternative position;

FIG. 8 is a left side, rear perspective view thereof with speakers and remote control in the position shown in FIG. 1;

FIG. 9 is an enlarged left side, rear perspective view of the remote control shown separately for clarity of illustration;

FIG. 10 is a top plan view thereof;

FIG. 11 is a rear elevational view thereof;

FIG. 12 is a left side elevational view thereof, the right side elevational view being a mirror image;

FIG. 13 is a bottom plan view thereof; and,

FIG. 14 is a front elevational view thereof.

1 Claim, 11 Drawing Sheets

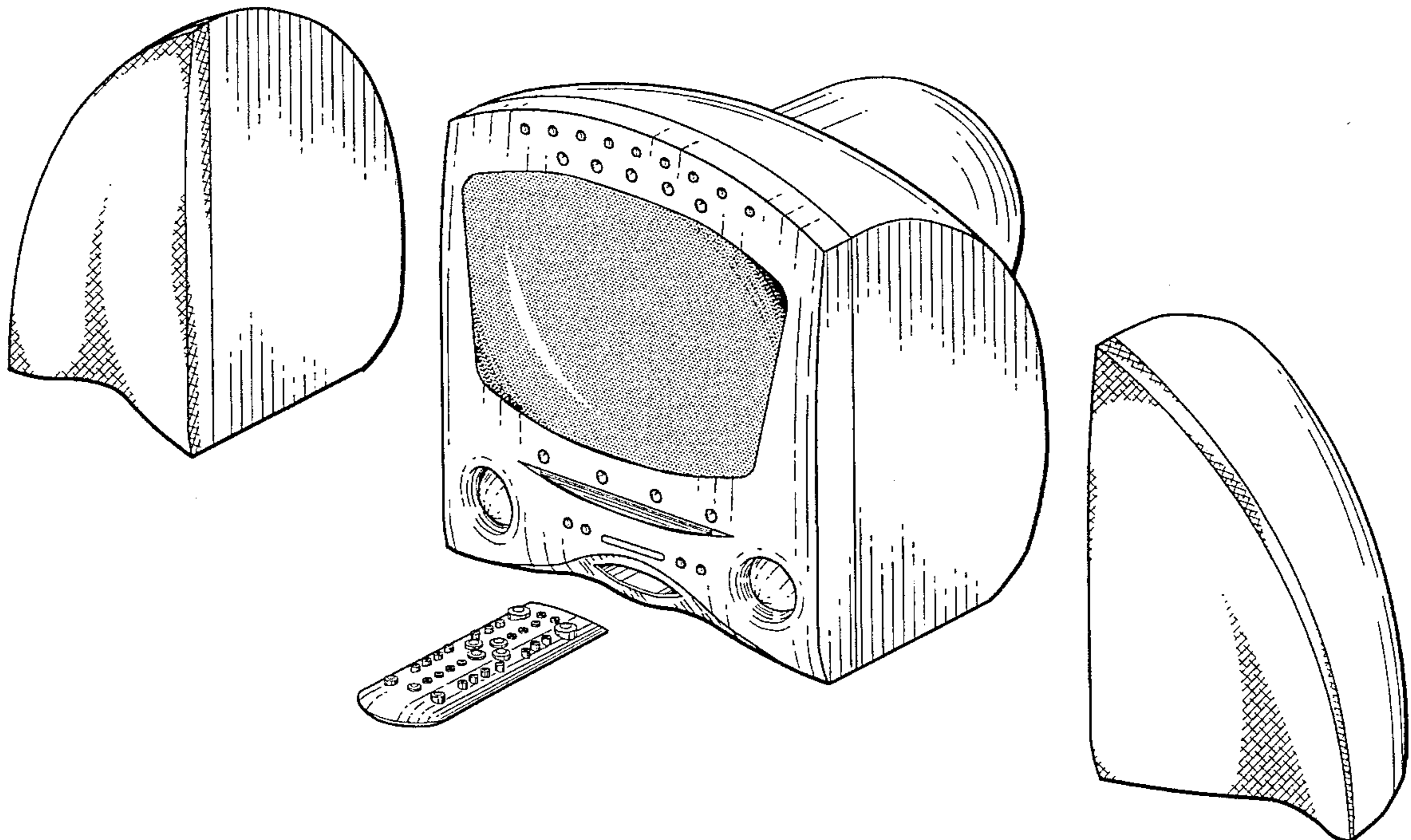

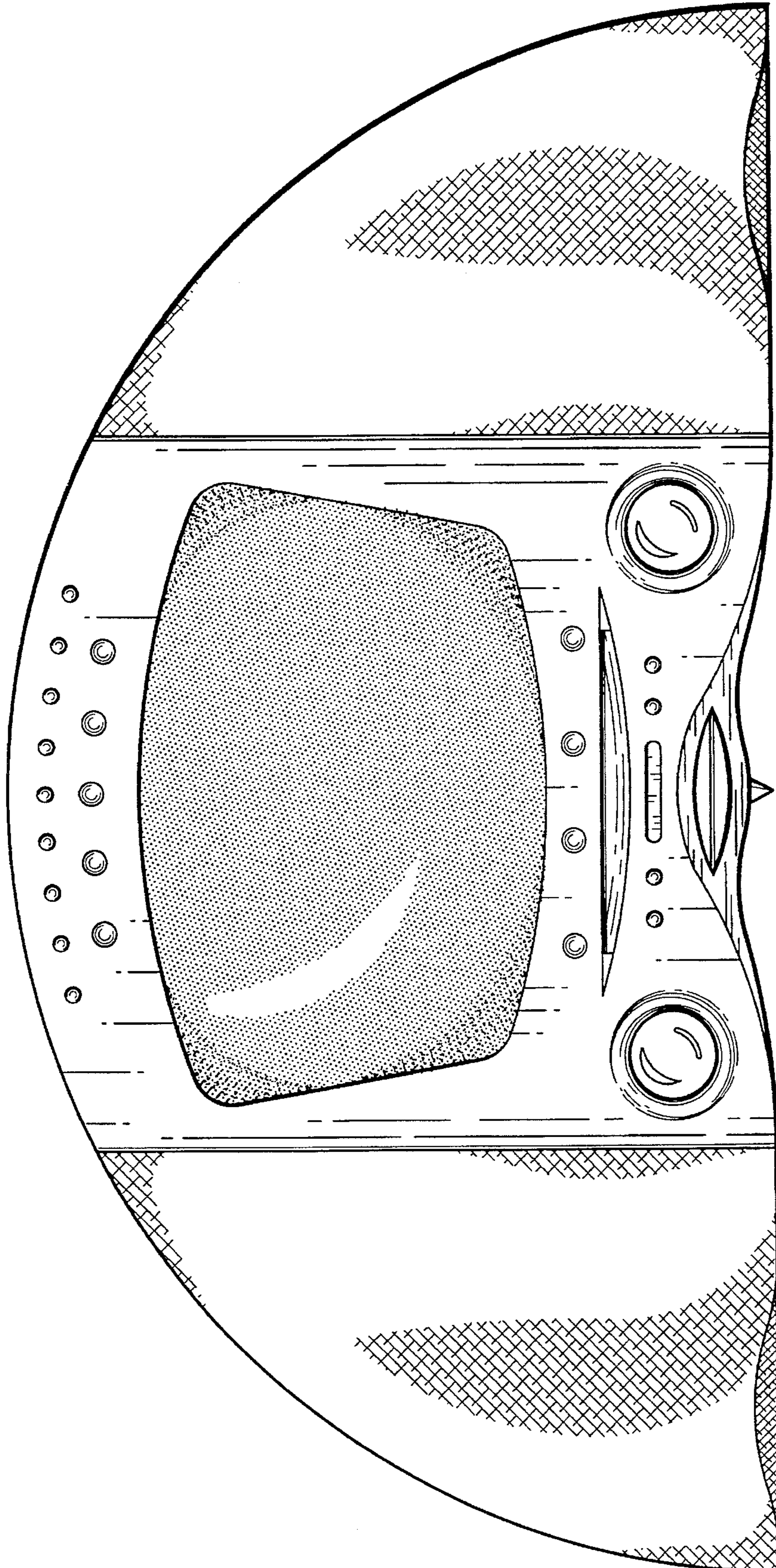

Fig. 1

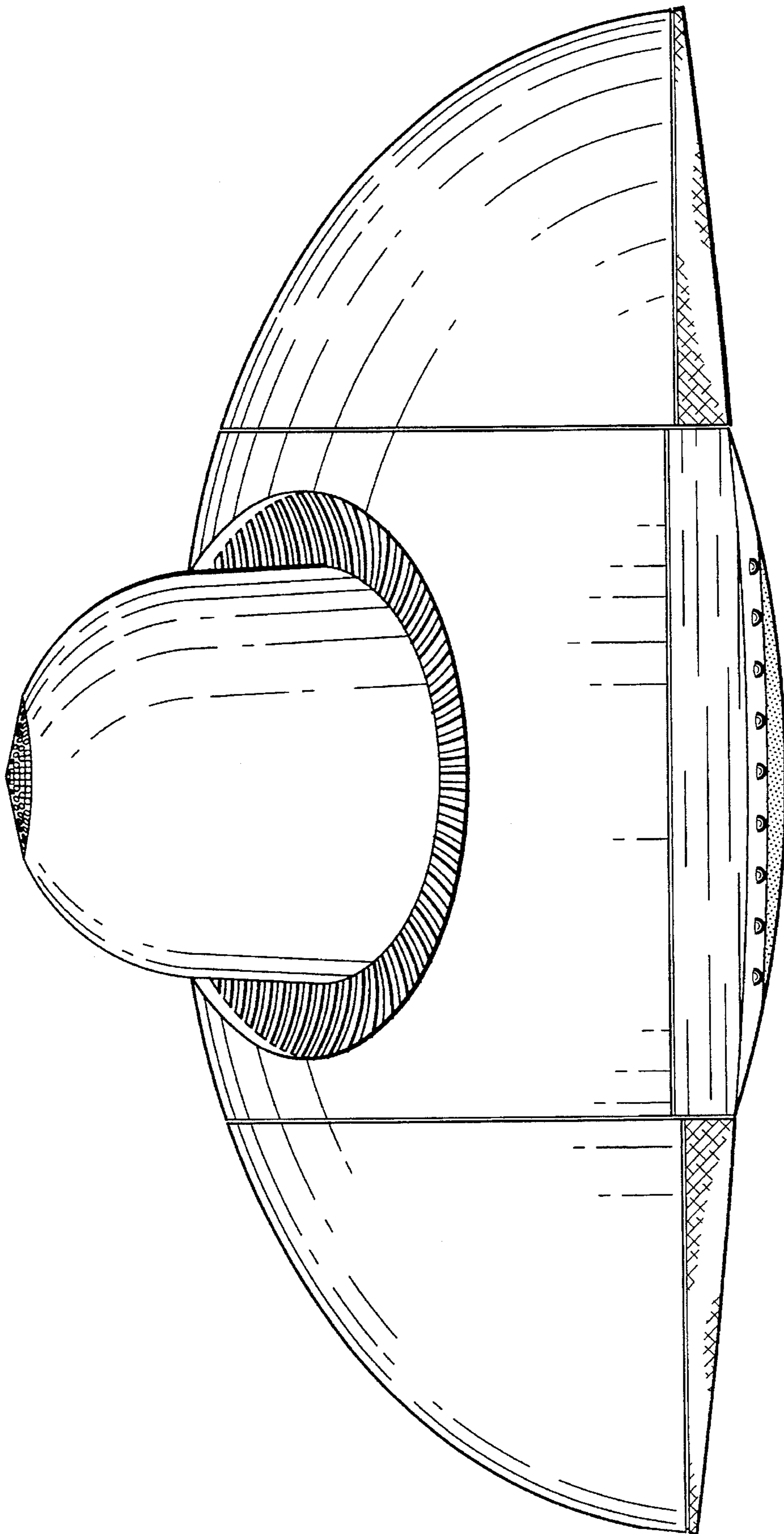

Fig. 2

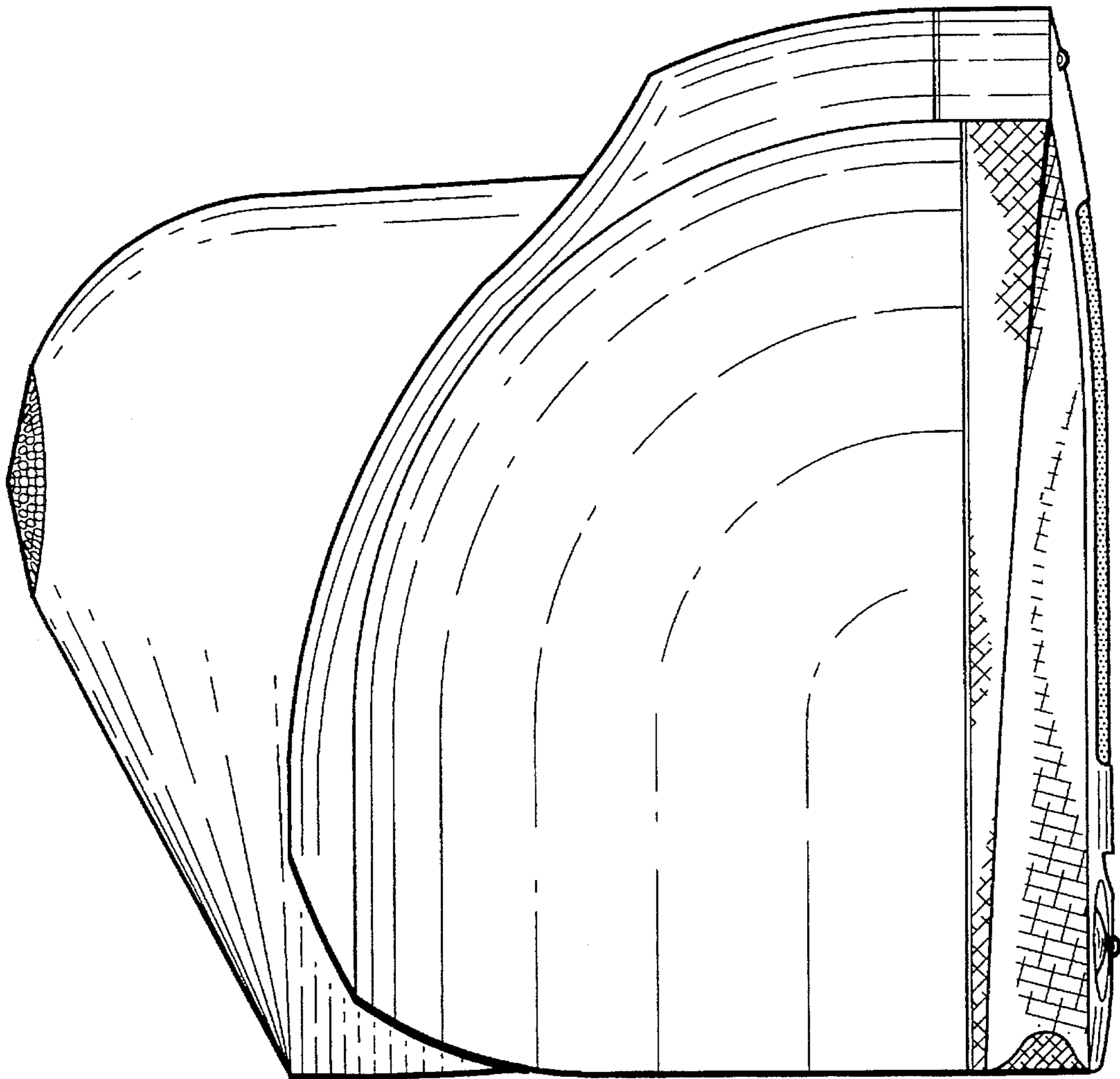

Fig. 3

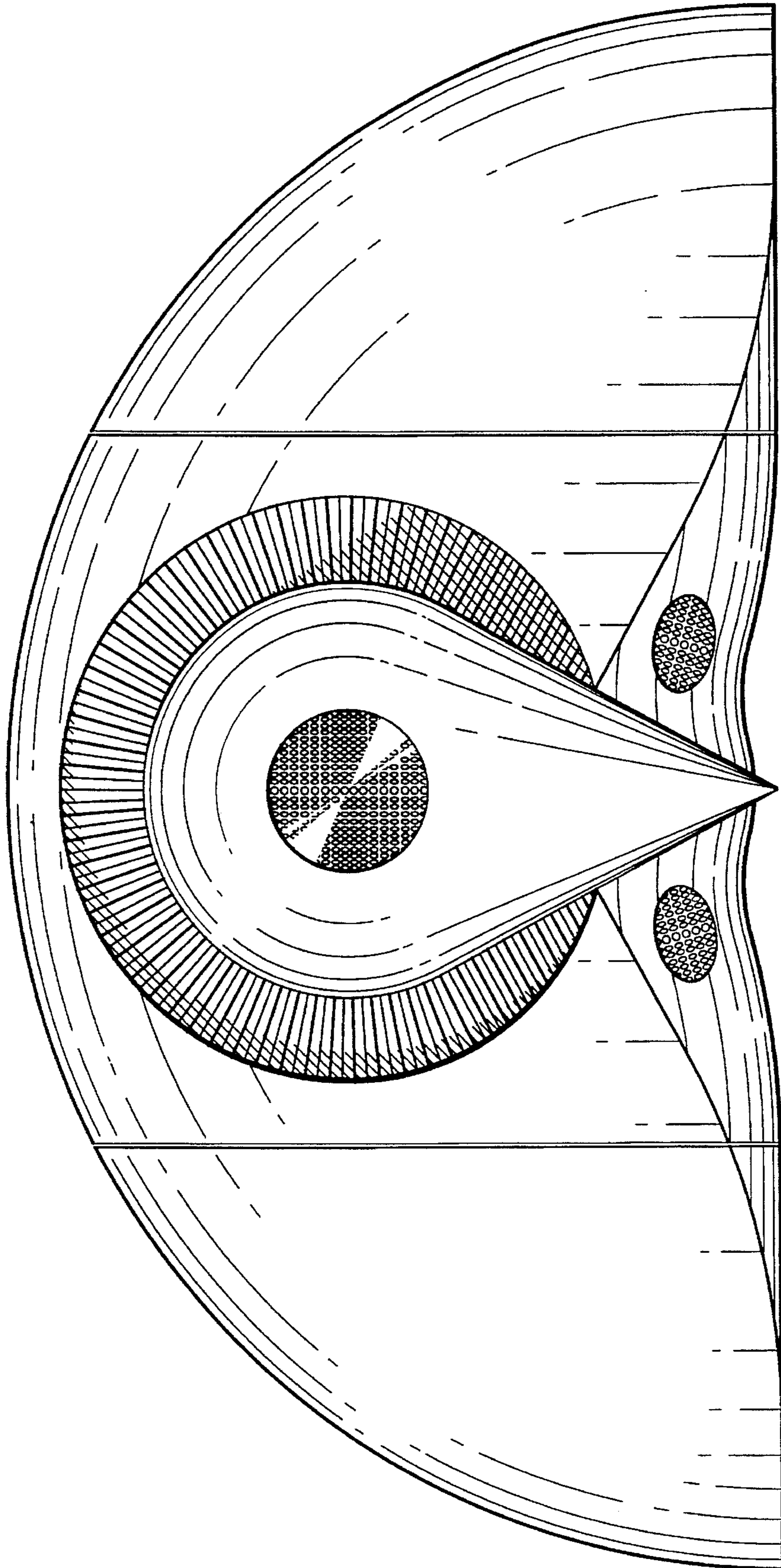

Fig. 4

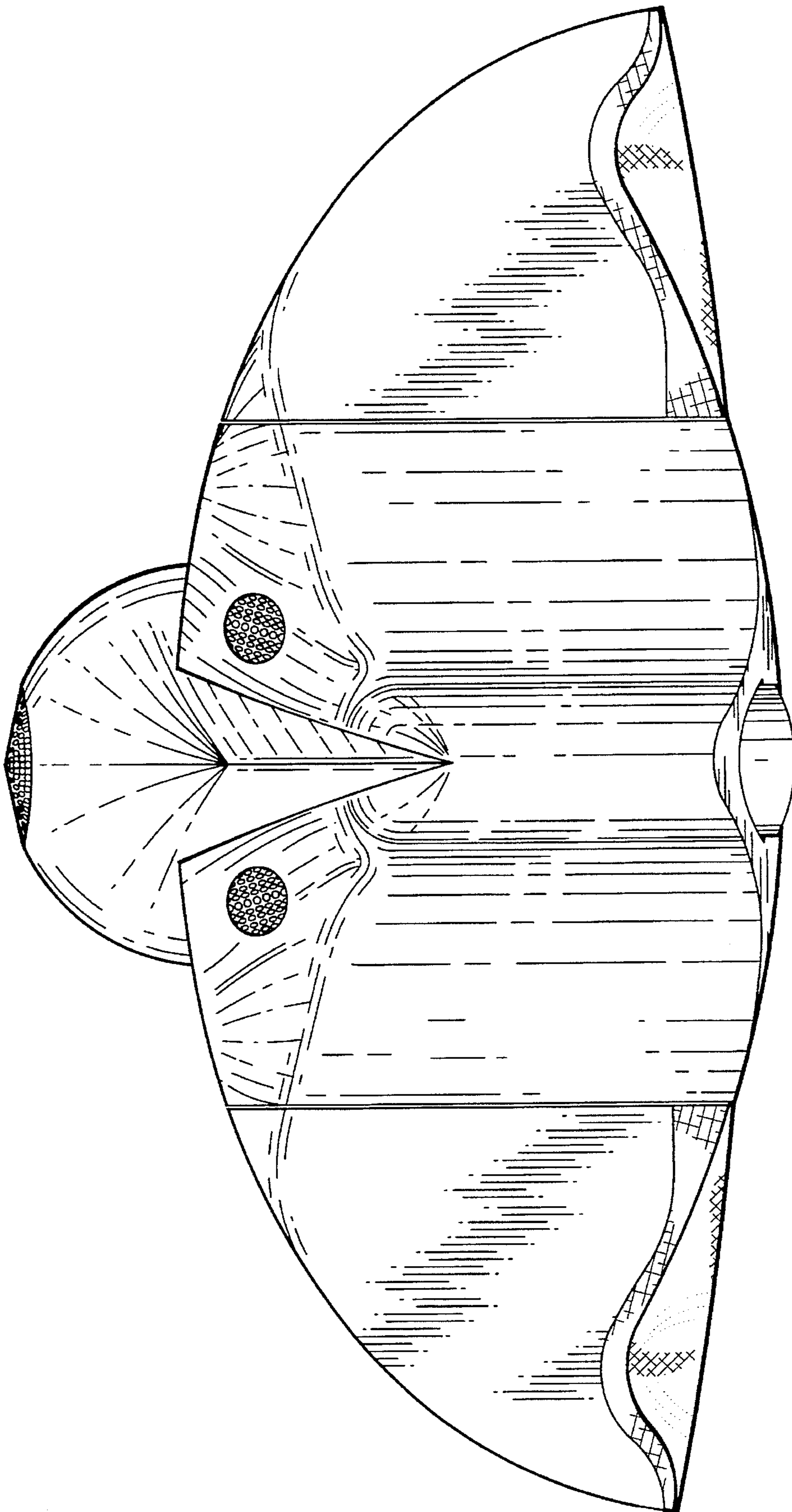

Fig. 5

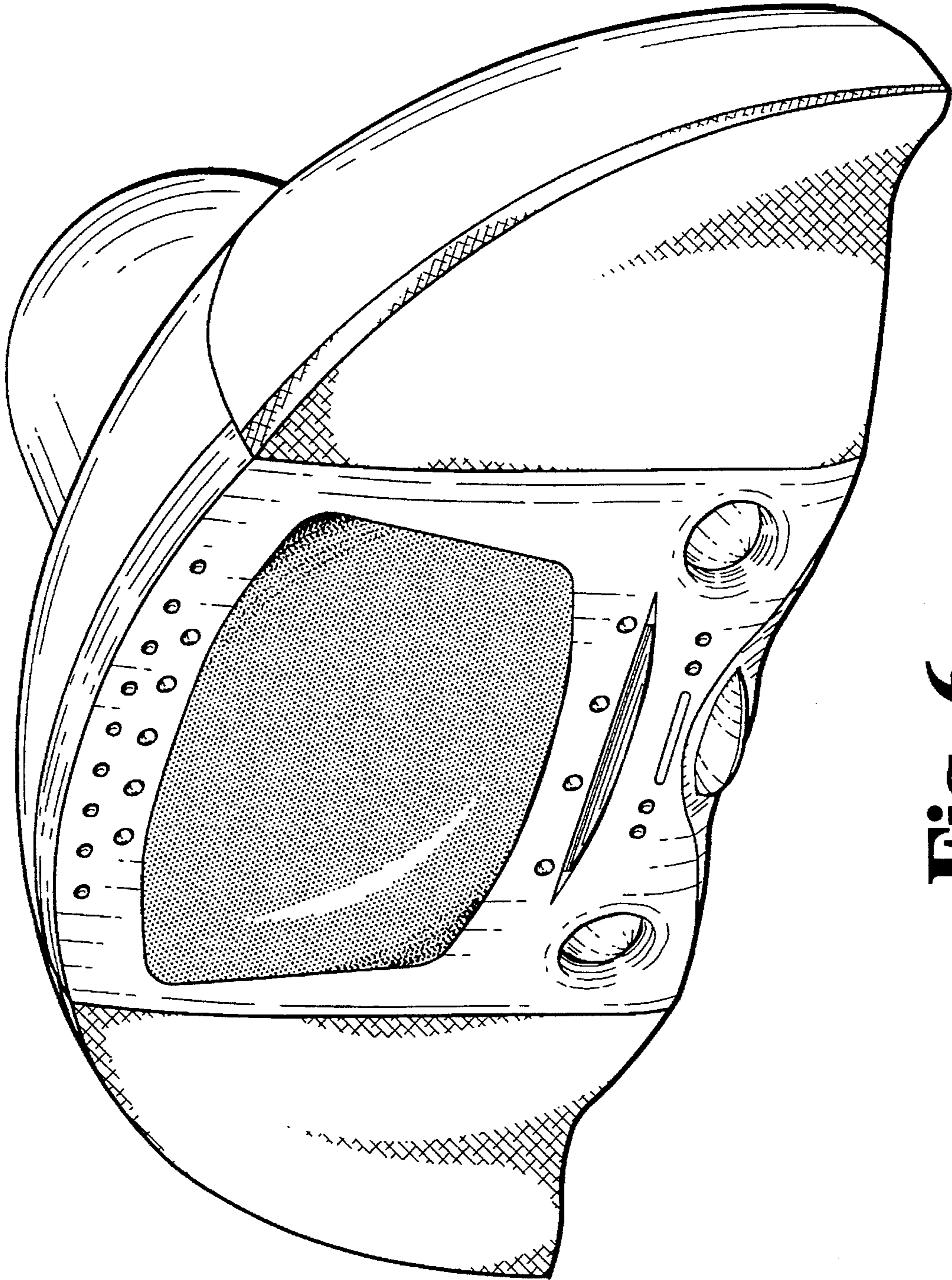

Fig. 6

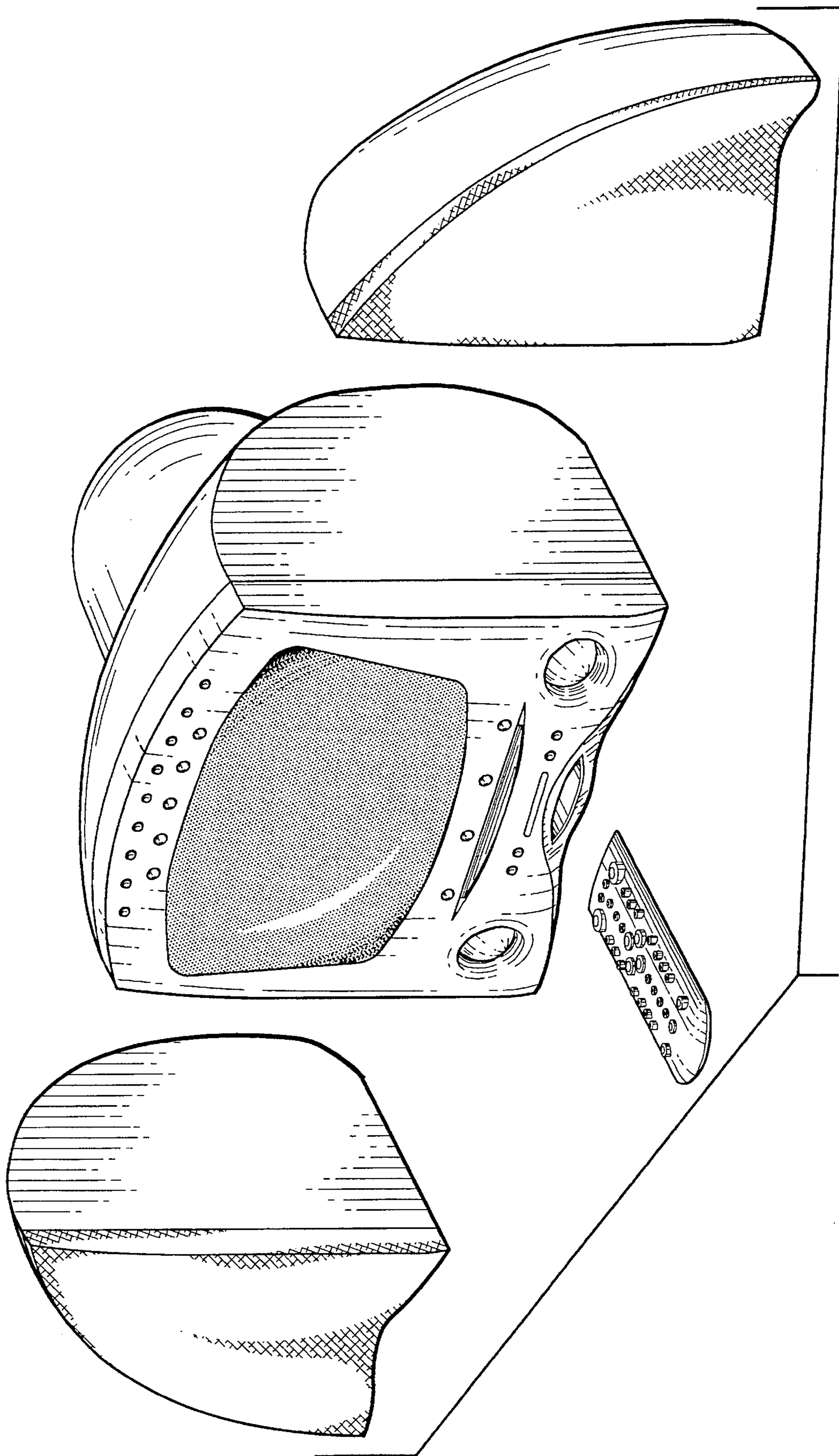

Fig. 7

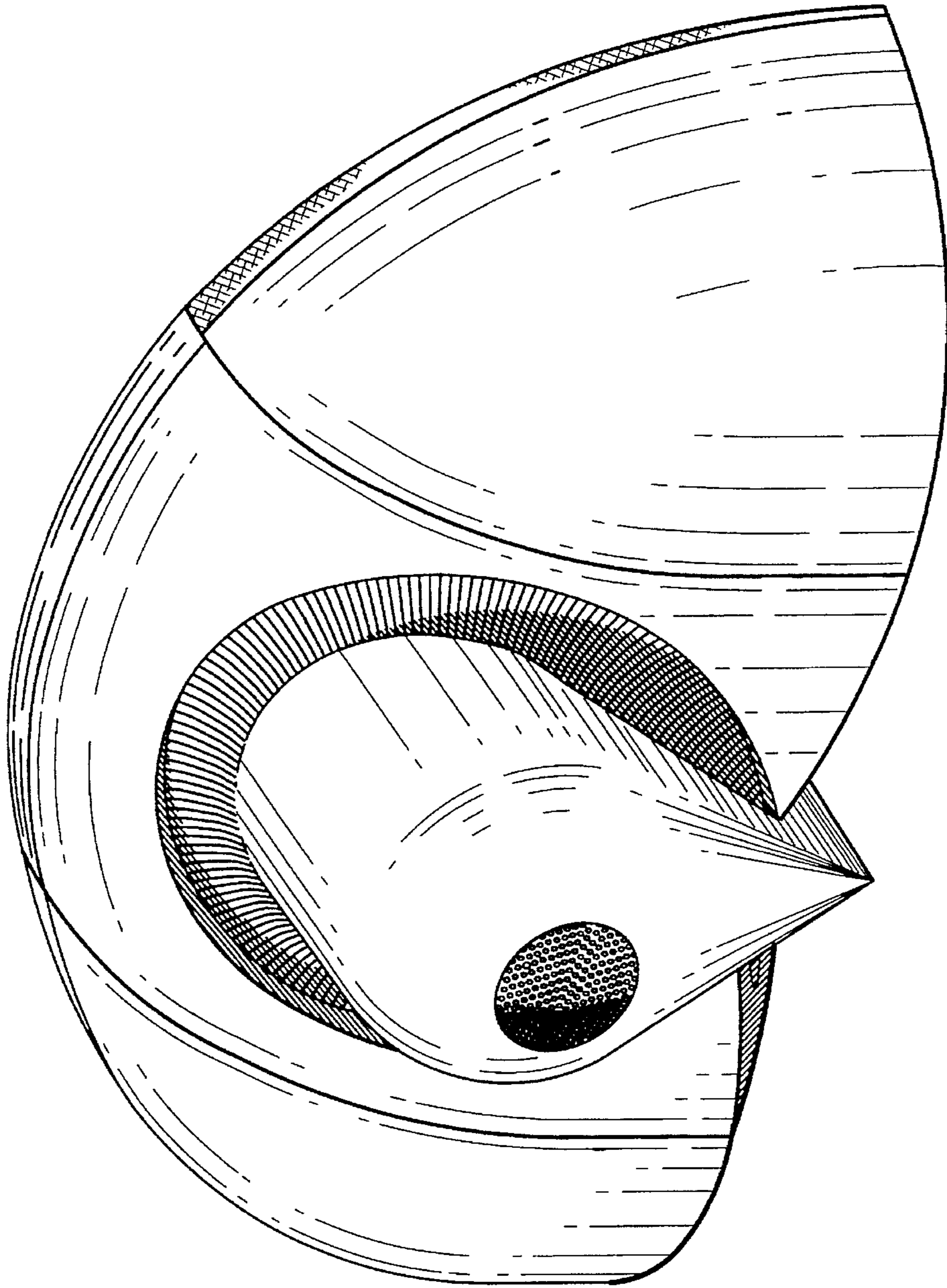

Fig. 8

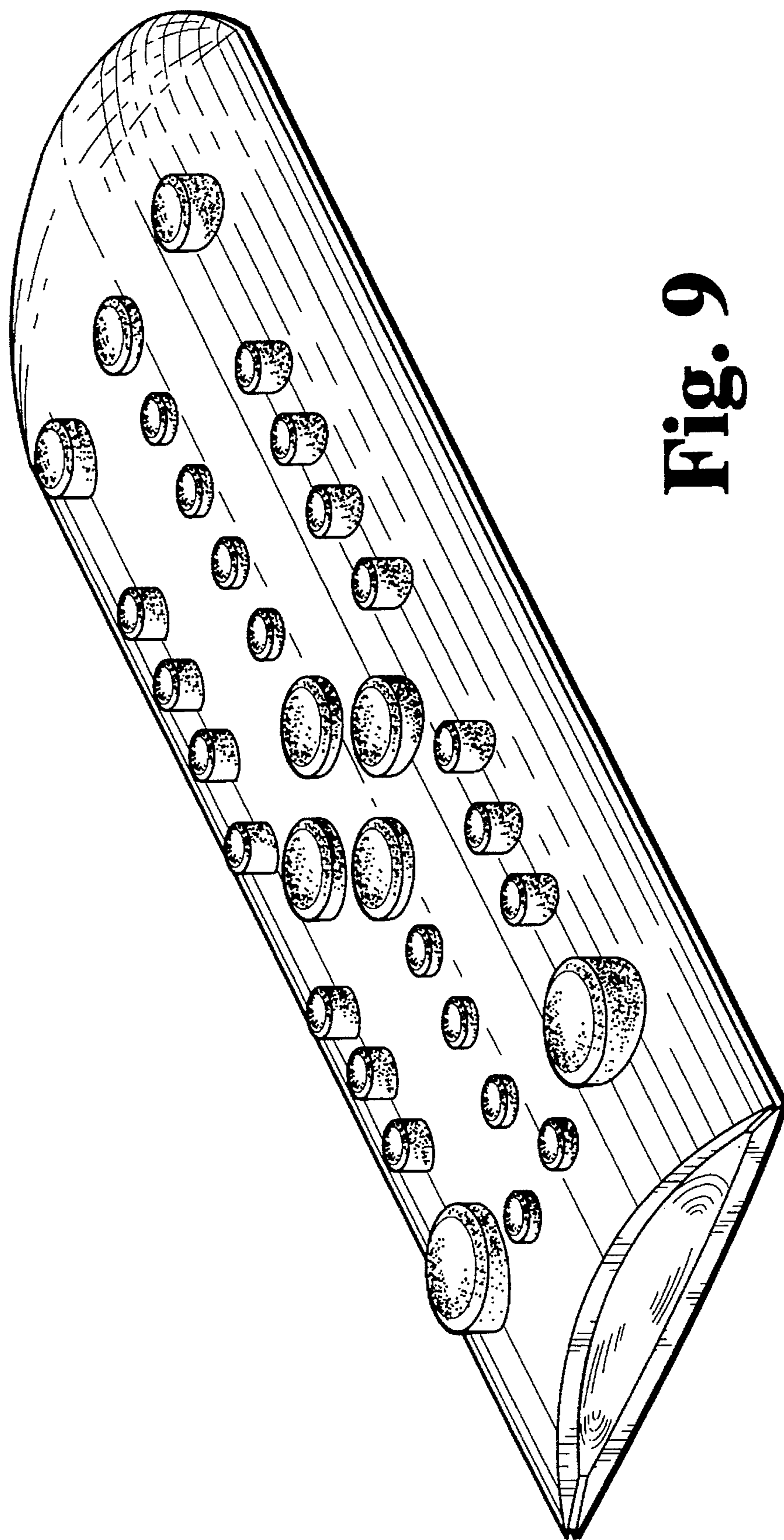

Fig. 9

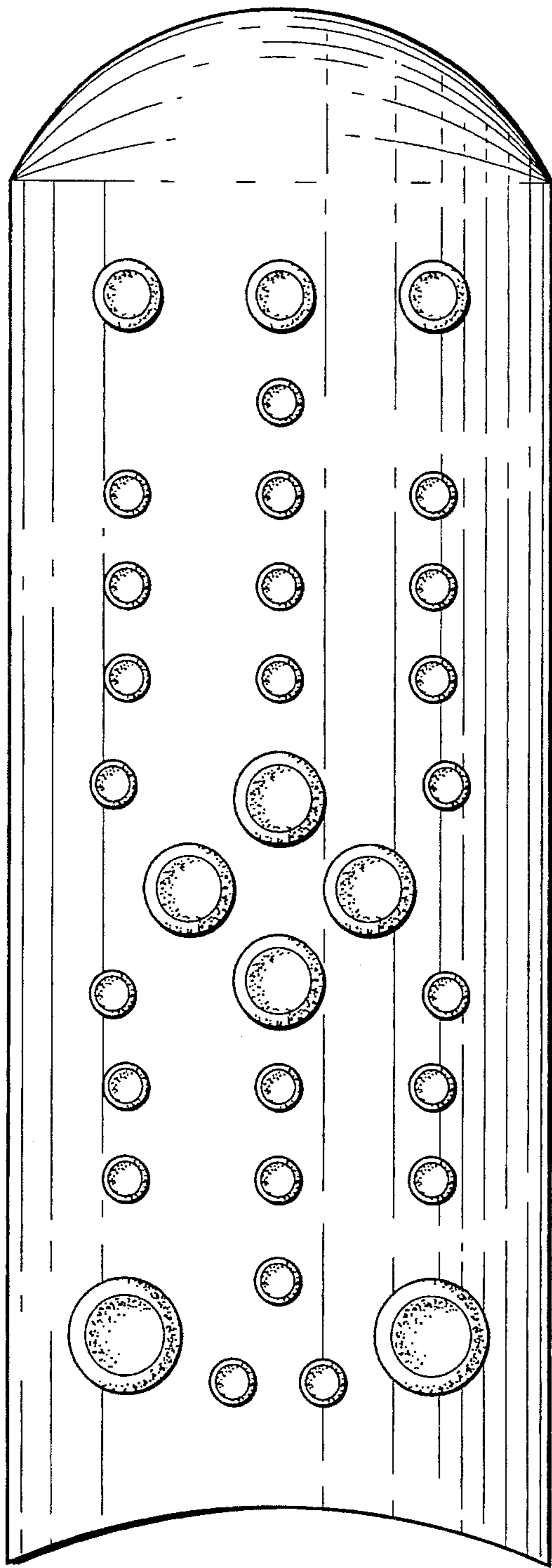

Fig. 10

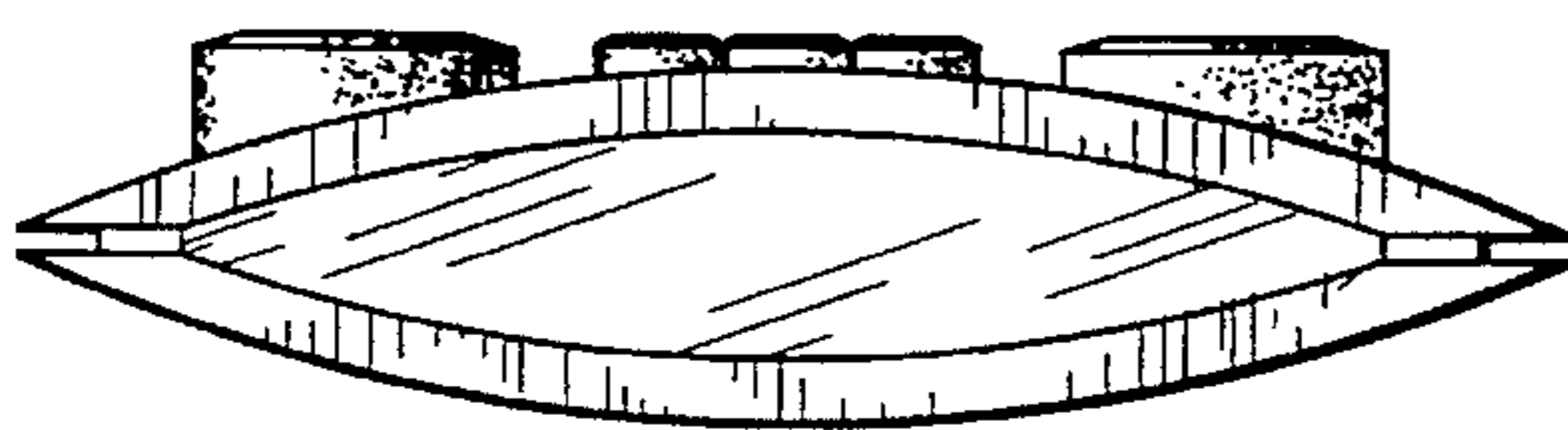

Fig. 11

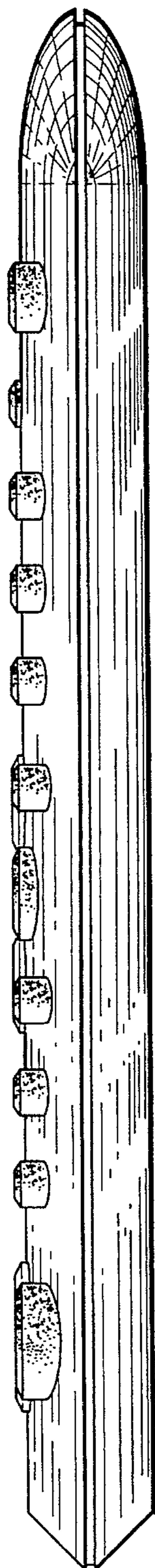

Fig. 12

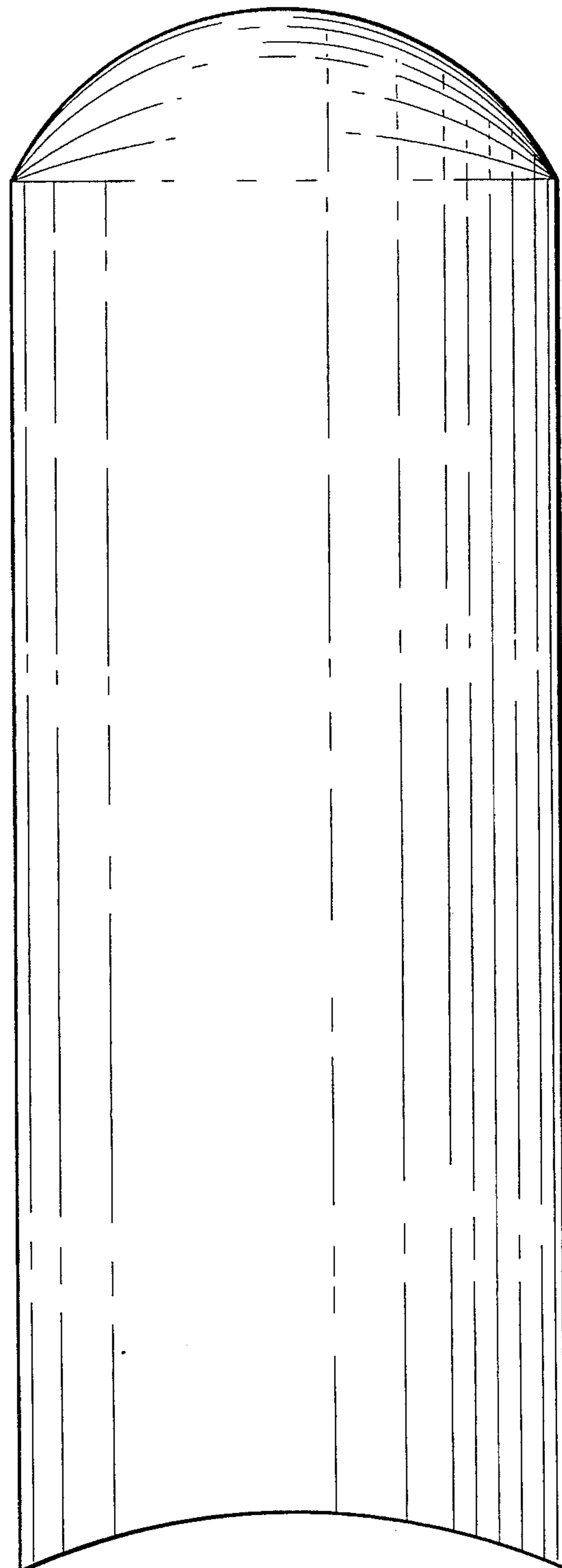

Fig. 13

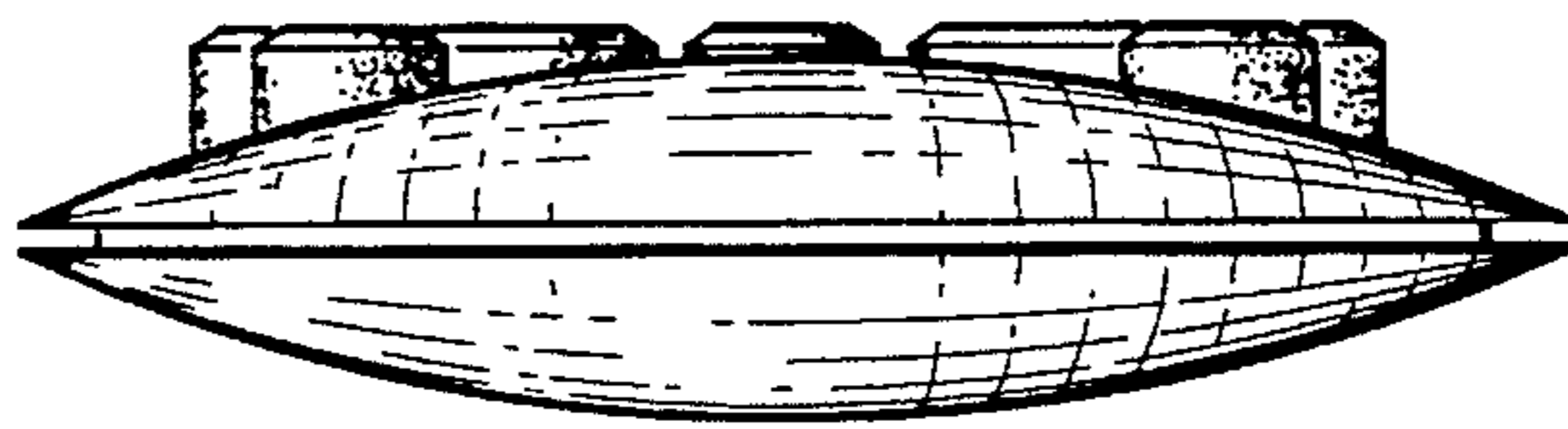

Fig. 14