



US00D377302S

# United States Patent [19]

Kazamaki et al.

[11] Patent Number: **Des. 377,302**

[45] Date of Patent: **\*\*Jan. 14, 1997**

[54] **STRAIGHT-HANDLE PULSE TOOL**

4,936,717 6/1990 Bosek ..... 144/218  
5,311,949 5/1994 Chapin ..... 173/170

[75] Inventors: **Yutaka Kazamaki**, New Hartford;  
**Joseph Groshans**, Clinton; **Robert Sienkiewicz**, Hamilton, all of N.Y.

### OTHER PUBLICATIONS

CP-456-L-N1 Needle Scaler, Chicago Pneumatic advertising flyer.

[73] Assignee: **Chicago Pneumatic Tool Company**, Utica, N.Y.

*Primary Examiner*—B. J. Bullock  
*Assistant Examiner*—Robert M. Spear  
*Attorney, Agent, or Firm*—Schmeiser, Olsen & Watts

[\*\*] Term: **14 Years**

[21] Appl. No.: **38,653**

### [57] CLAIM

[22] Filed: **May 11, 1995**

The ornamental design for a straight-handle pulse tool, as shown.

[52] U.S. Cl. .... **D8/61**

[58] Field of Search ..... D8/61, 64, 67,  
D8/68, 82; D24/146; 81/57, 57.11, 57.14,  
177.4, 469, 474; 144/150, 218; 173/169,  
170

### DESCRIPTION

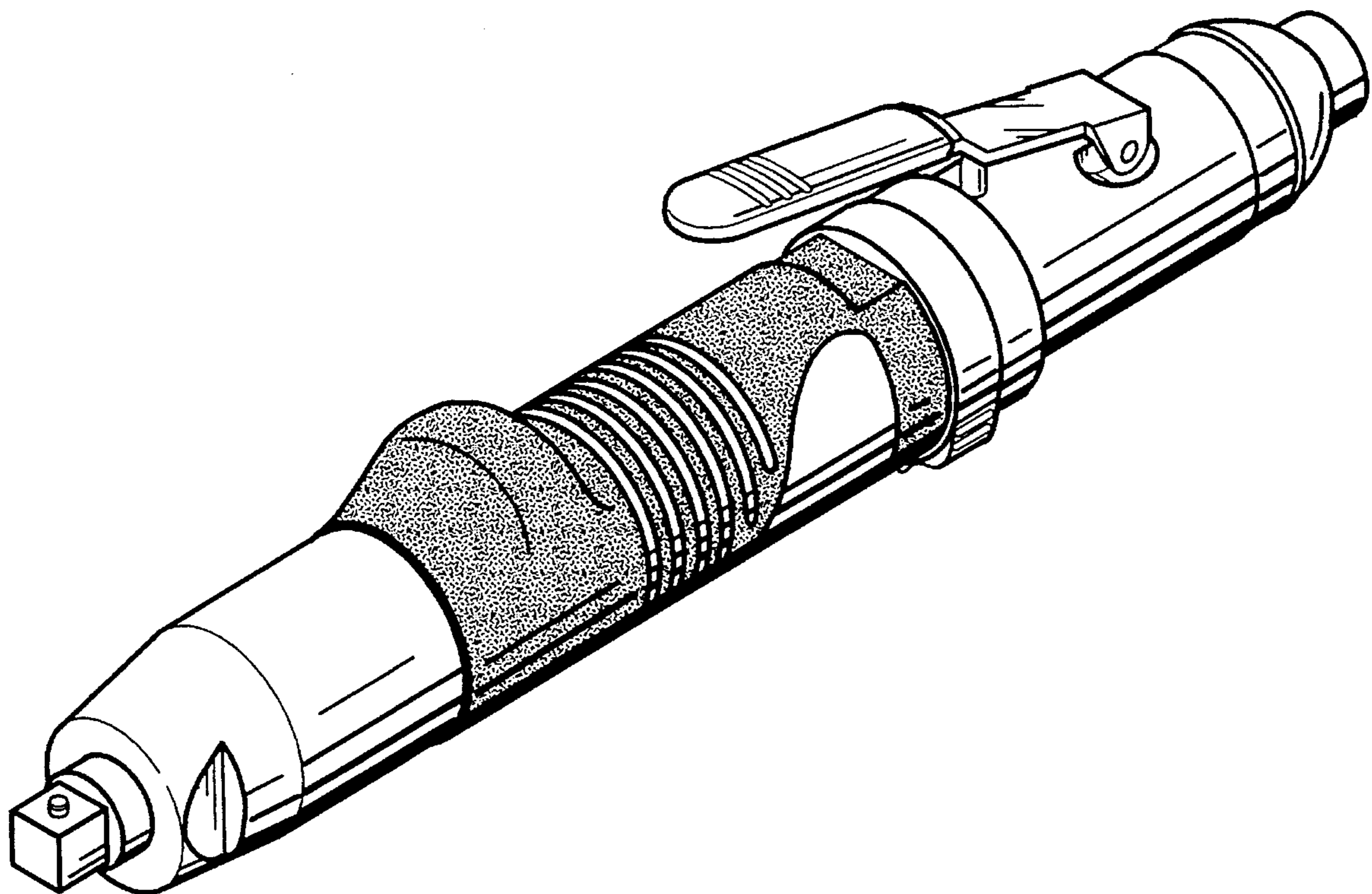
FIG. 1 is a top plan view of a straight-handle pulse tool, showing our new design;  
FIG. 2 is a right side elevational view thereof;  
FIG. 3 is a left side elevational view thereof;  
FIG. 4 is a rear elevational view thereof;  
FIG. 5 is a front elevational view thereof;  
FIG. 6 is a top right perspective view thereof; and,  
FIG. 7 is a bottom left perspective view thereof.

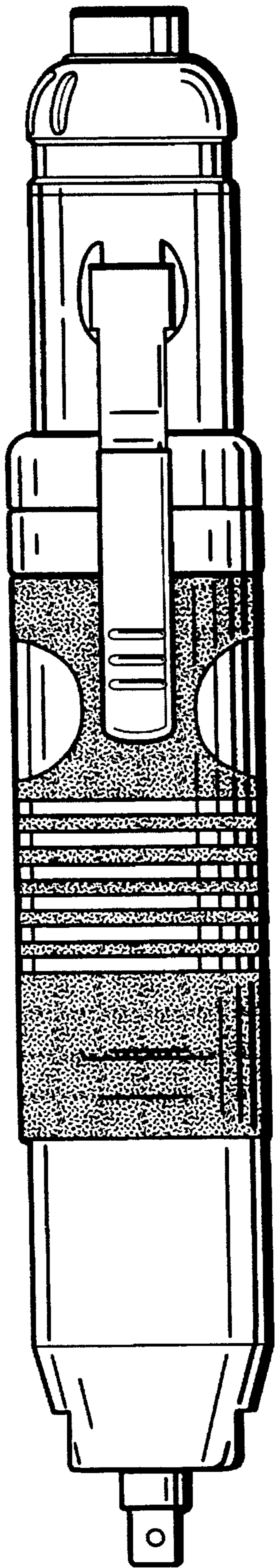
### [56] References Cited

#### U.S. PATENT DOCUMENTS

D. 173,326	10/1954	Quackenbush	.....	D8/61
D. 323,275	1/1992	Sasaki et al.	.....	D8/61
D. 343,344	1/1994	Chapin	.....	D8/61
4,354,667	3/1981	Wong	.....	173/170

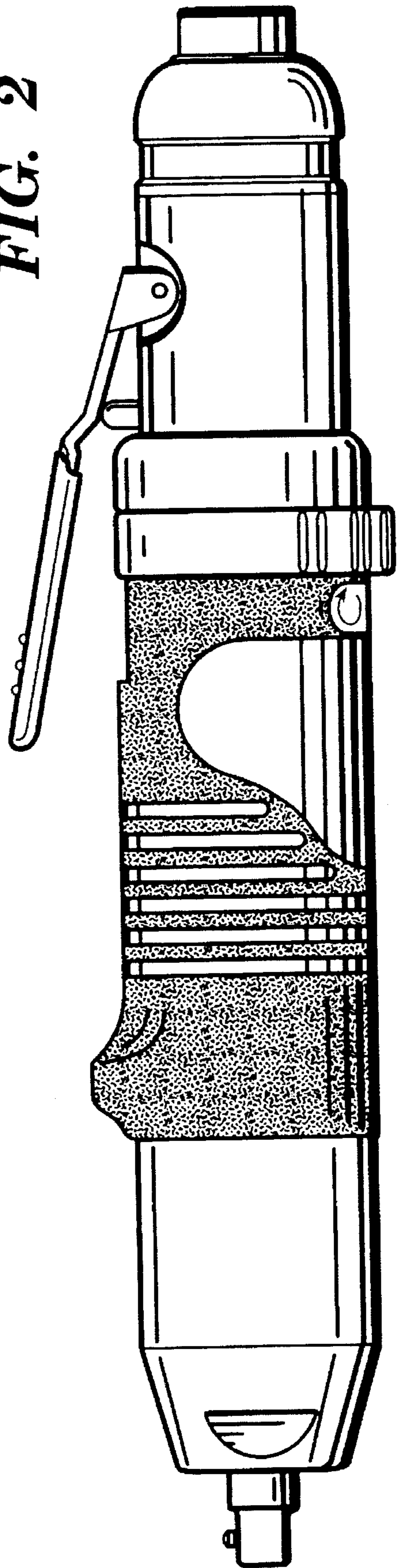
**1 Claim, 4 Drawing Sheets**

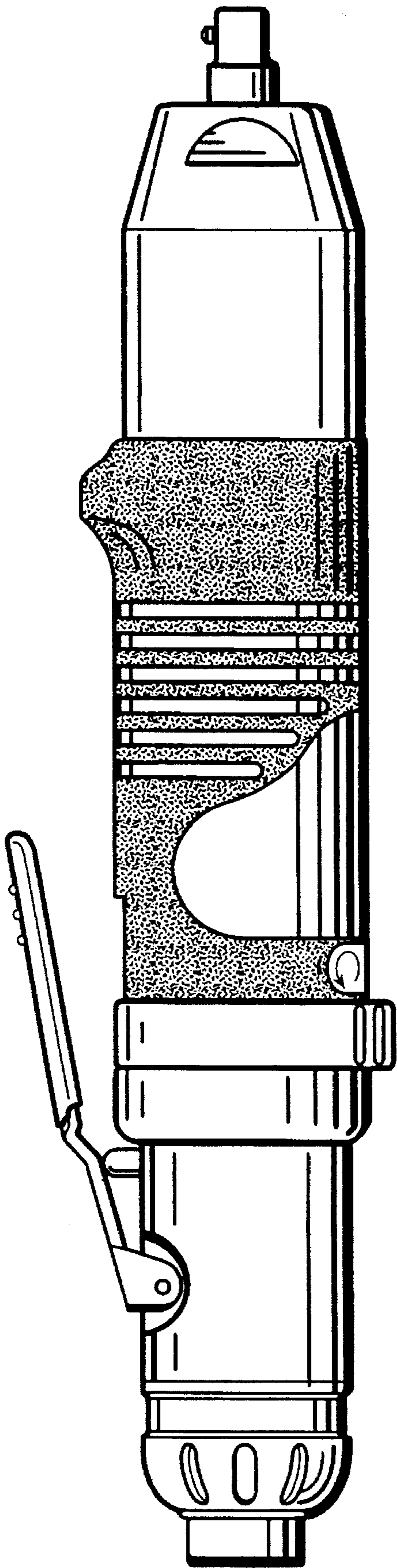




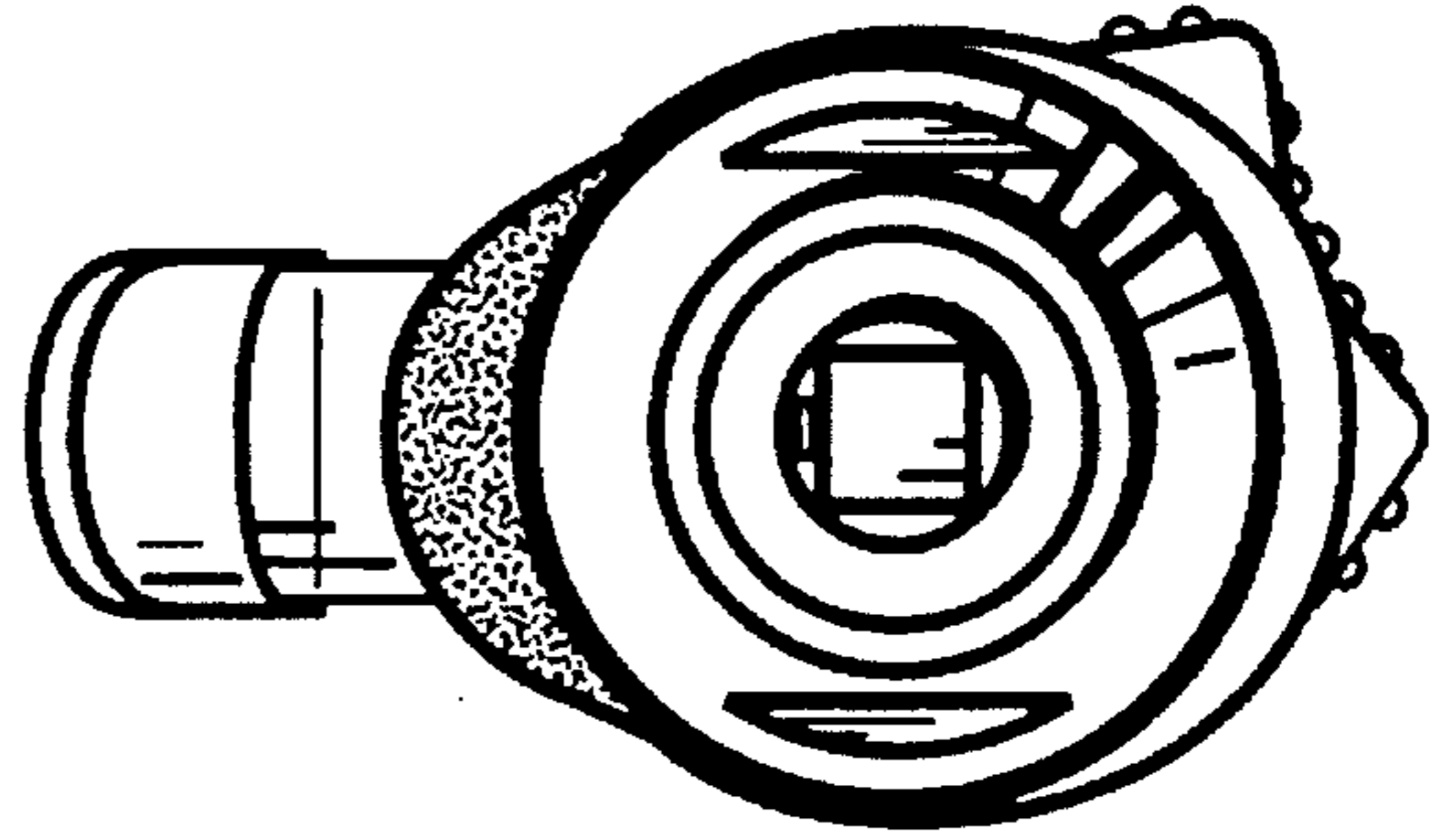
**FIG. 1**

**FIG. 2**

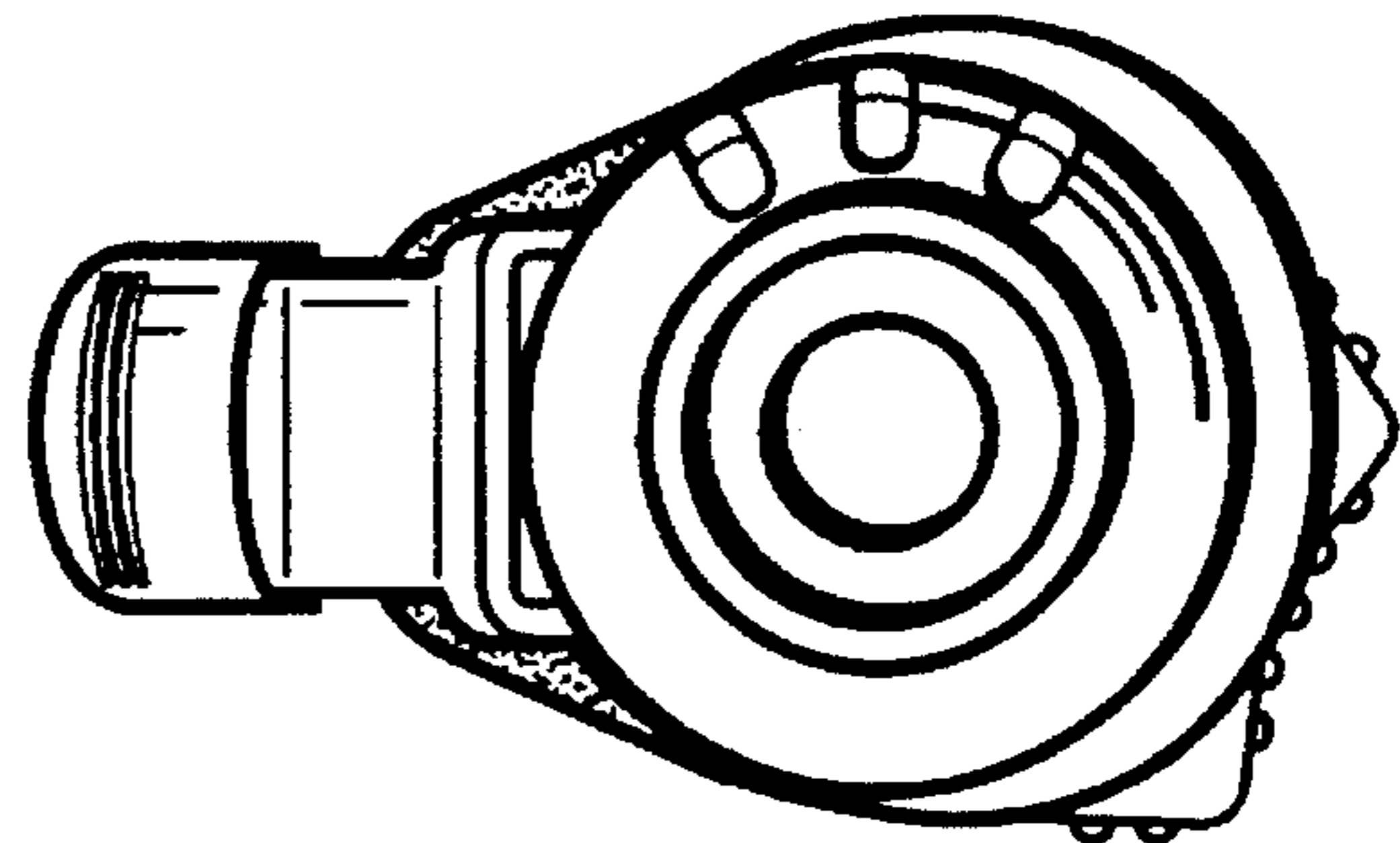




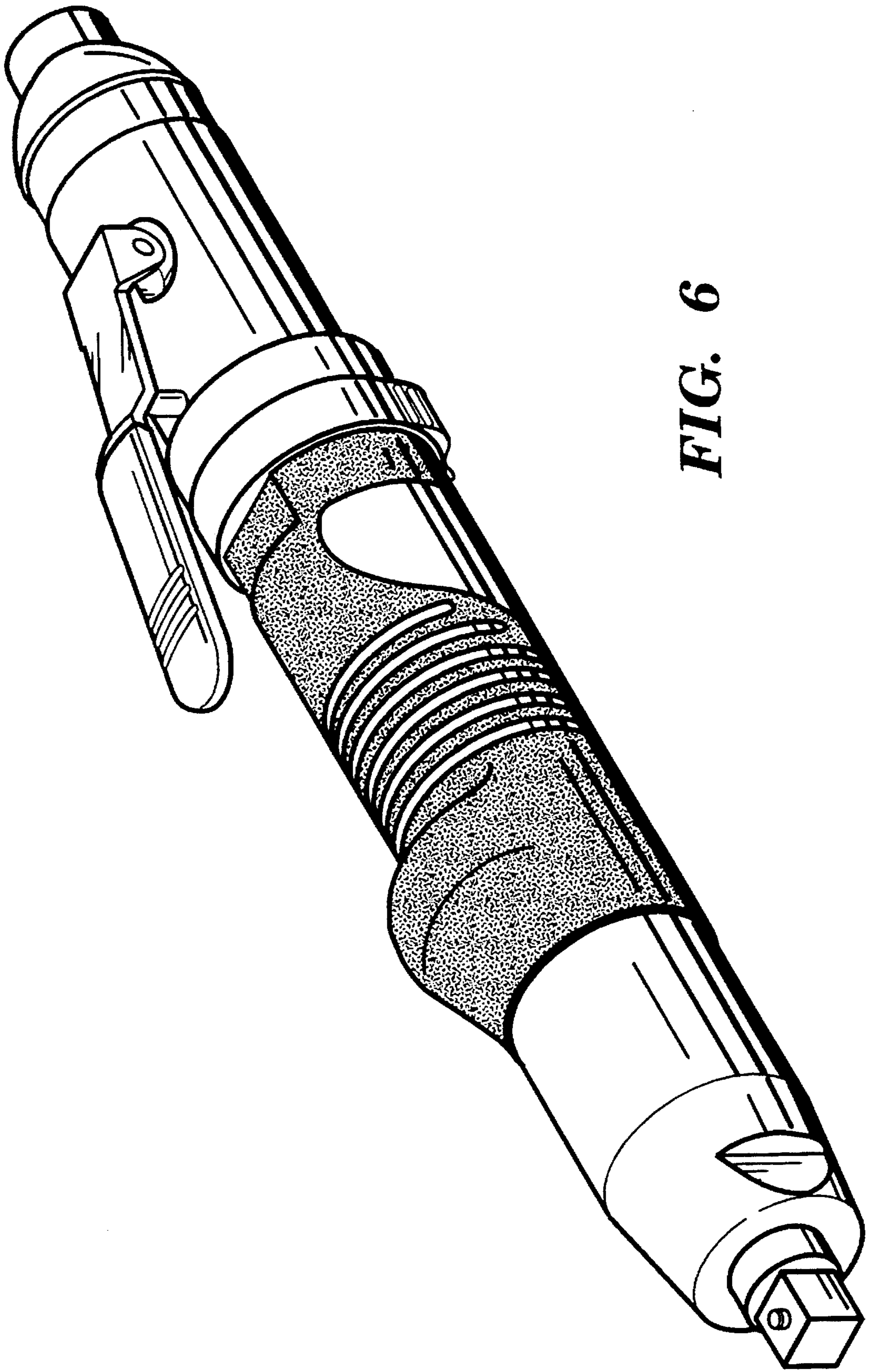
**FIG. 3**



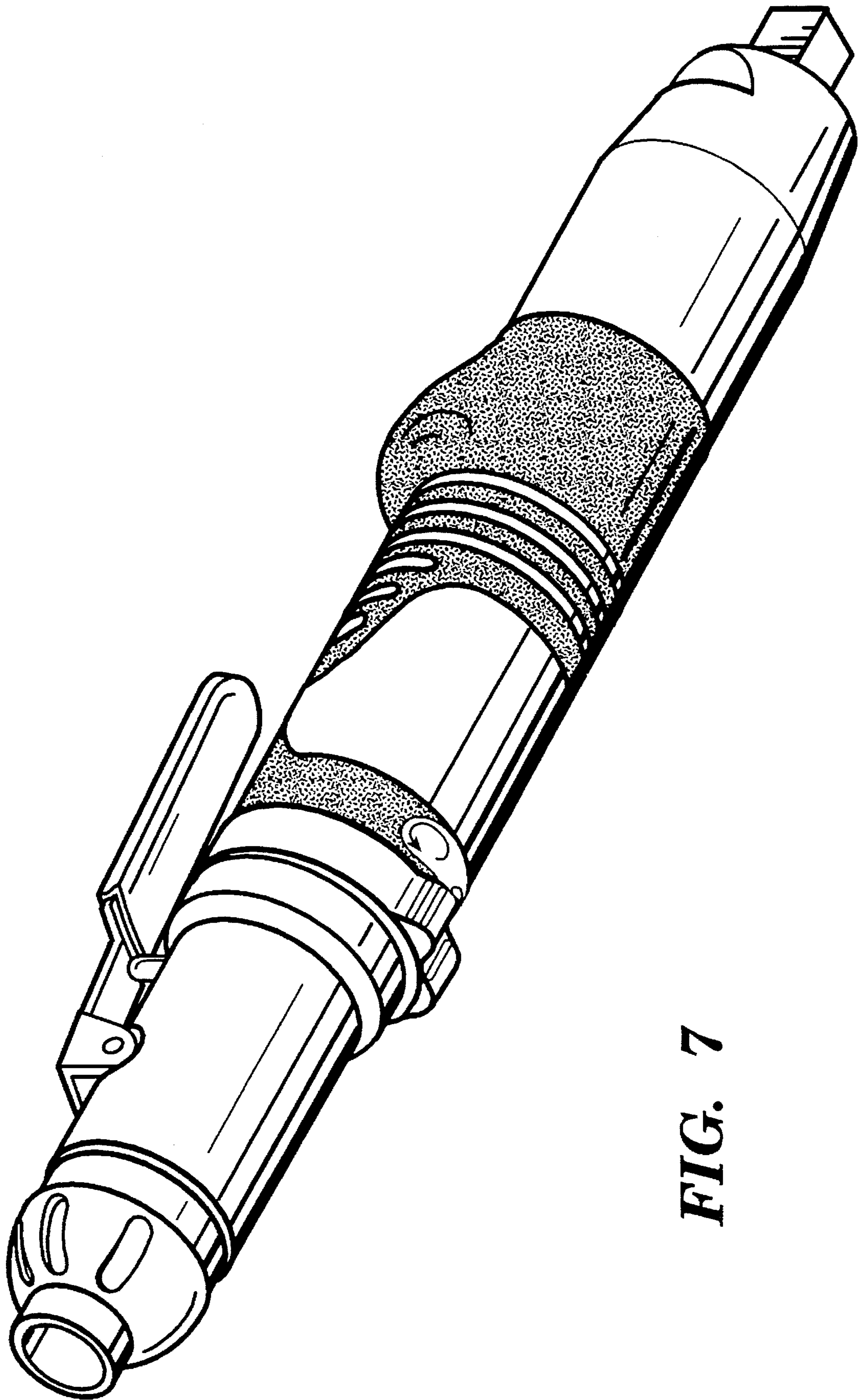
**FIG. 4**



**FIG. 5**



**FIG. 6**



**FIG. 7**