



US00D377276S

# United States Patent [19]

Hirsch et al.

[11] Patent Number: Des. 377,276

[45] Date of Patent: \*\*Jan. 14, 1997

[54] **READING STAND**

[76] Inventors: **Steven Hirsch**, 13040 Woodbridge St., Studio City, Calif. 91604; **Joseph Yedvab**, 4915 Gaviota Ave., Encino, Calif. 91436

[\*\*] Term: **14 Years**

[21] Appl. No.: **41,678**

[22] Filed: **Jul. 21, 1995**

[52] U.S. Cl. .... **D6/419**

[58] Field of Search ..... D6/419, 420, 429-431; 248/441.1, 460, 454, 456, 448, 449; D19/90, 91

[56] **References Cited**

**U.S. PATENT DOCUMENTS**

D. 186,895	12/1959	Wenger	.....	D6/419
D. 239,899	5/1976	Malcolm	.....	D6/419
D. 246,016	10/1977	Brady	.....	D6/419
D. 296,851	7/1988	Kelley	.....	D6/420

D. 324,462	3/1992	Karmaze	.....	D6/419
D. 329,762	9/1992	Weeks	.....	D6/419
D. 348,992	7/1994	Arima	.....	D6/420

*Primary Examiner*—Carmen H. Vales-Lado  
*Attorney, Agent, or Firm*—Thomas I. Rozsa; Tony D. Chen

[57] **CLAIM**

The ornamental design for a reading stand, as shown and described.

**DESCRIPTION**

FIG. 1 is a perspective view of a reading stand, showing our new design;  
FIG. 2 is a front elevational view;  
FIG. 3 is a rear elevational view;  
FIG. 4 is a top plan view;  
FIG. 5 is a bottom plan view;  
FIG. 6 is a right side elevational view when viewed from the front; and,  
FIG. 7 is a left side elevational view when viewed from the front.

**1 Claim, 3 Drawing Sheets**

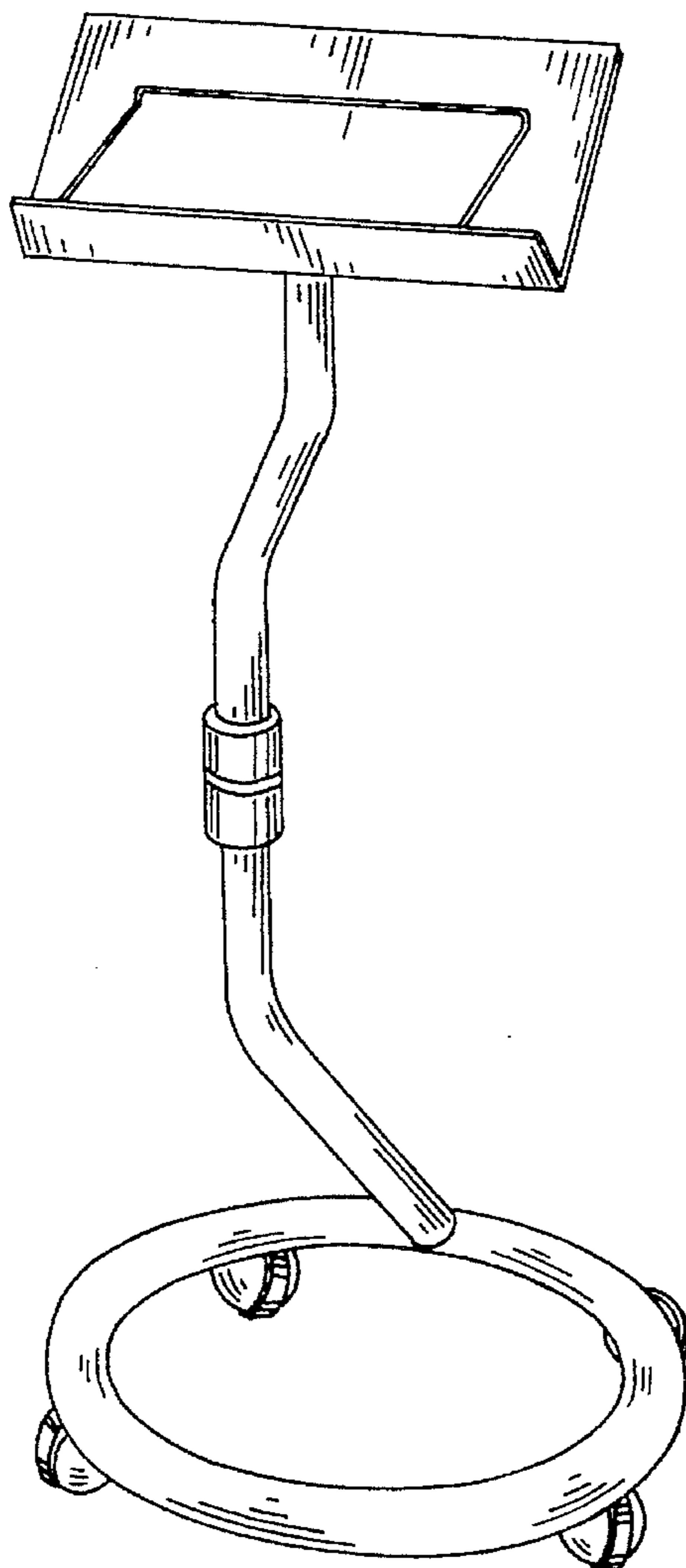

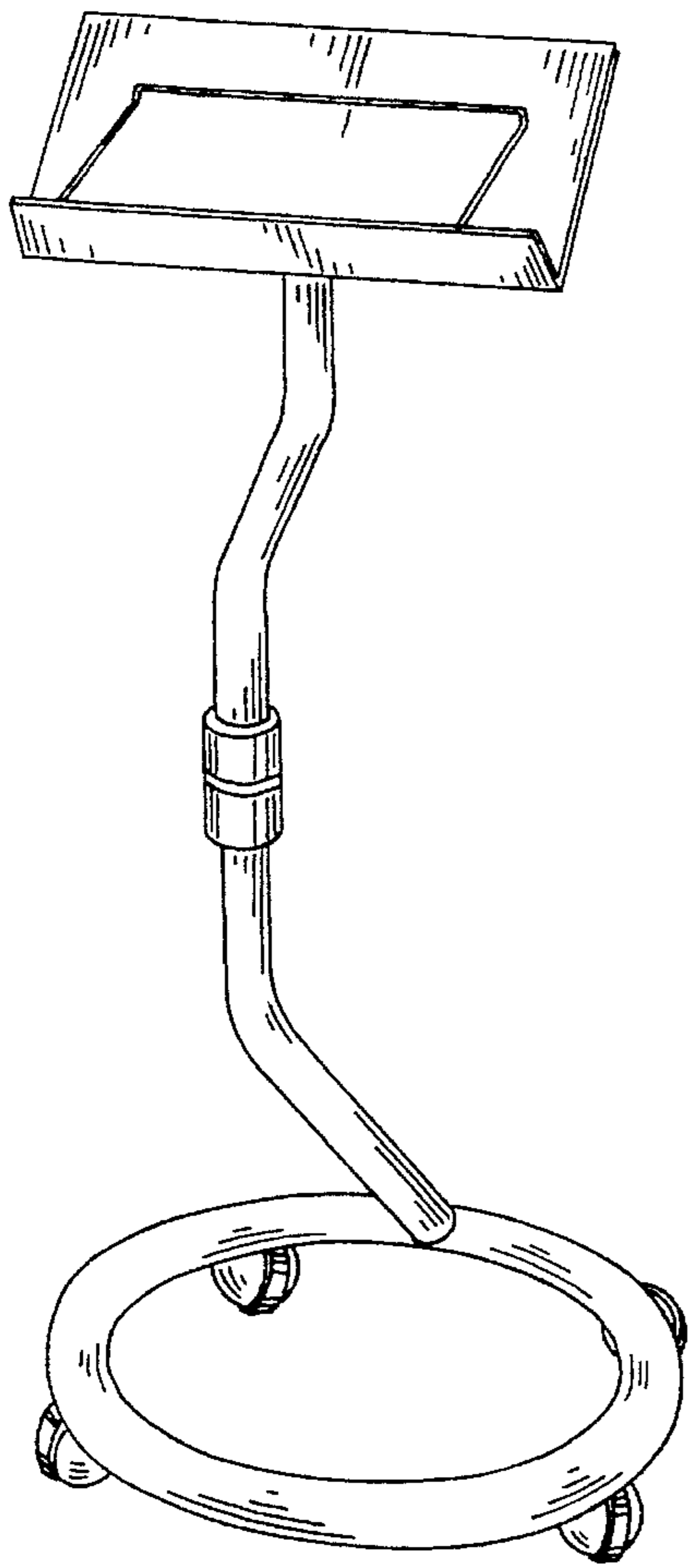

FIG.1

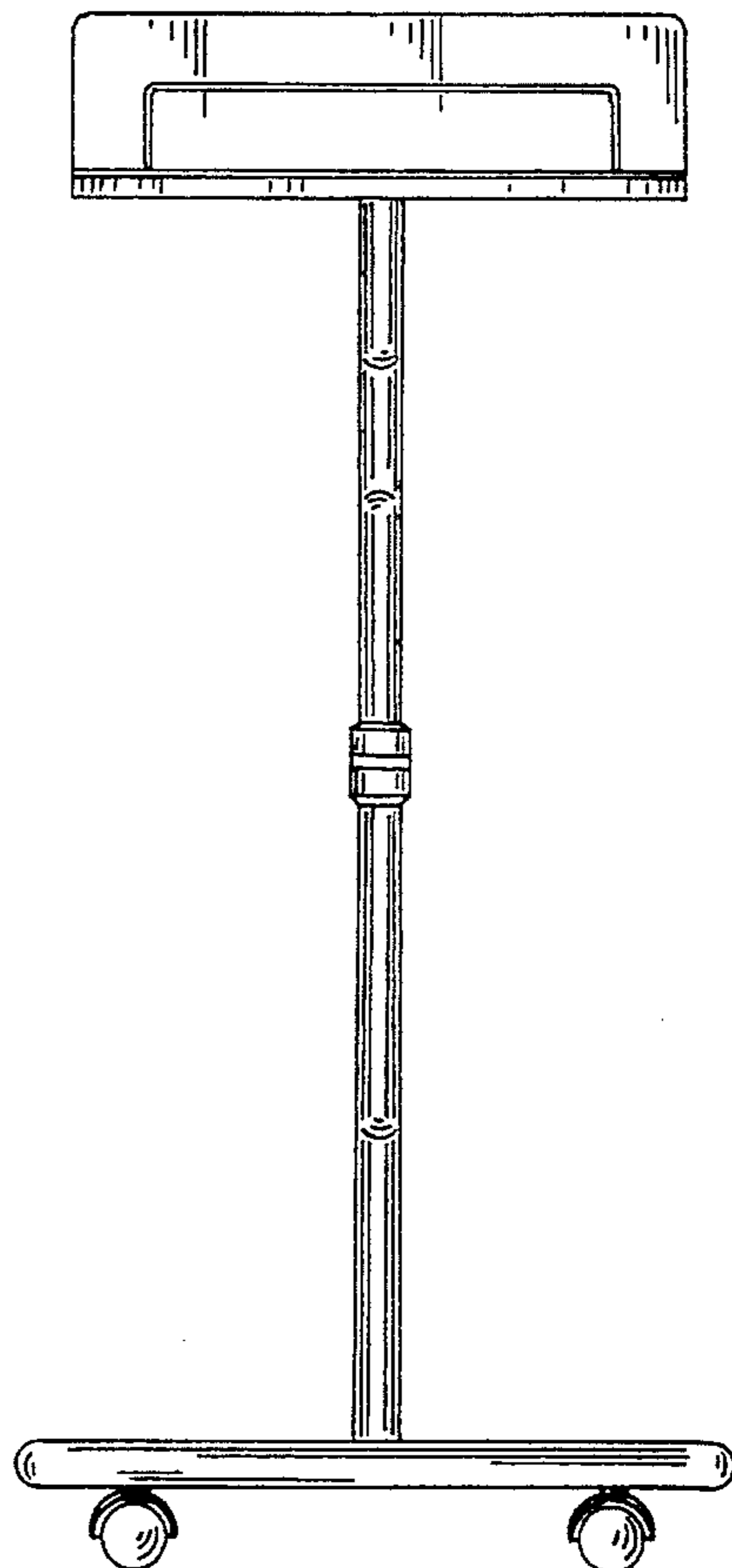

FIG.2

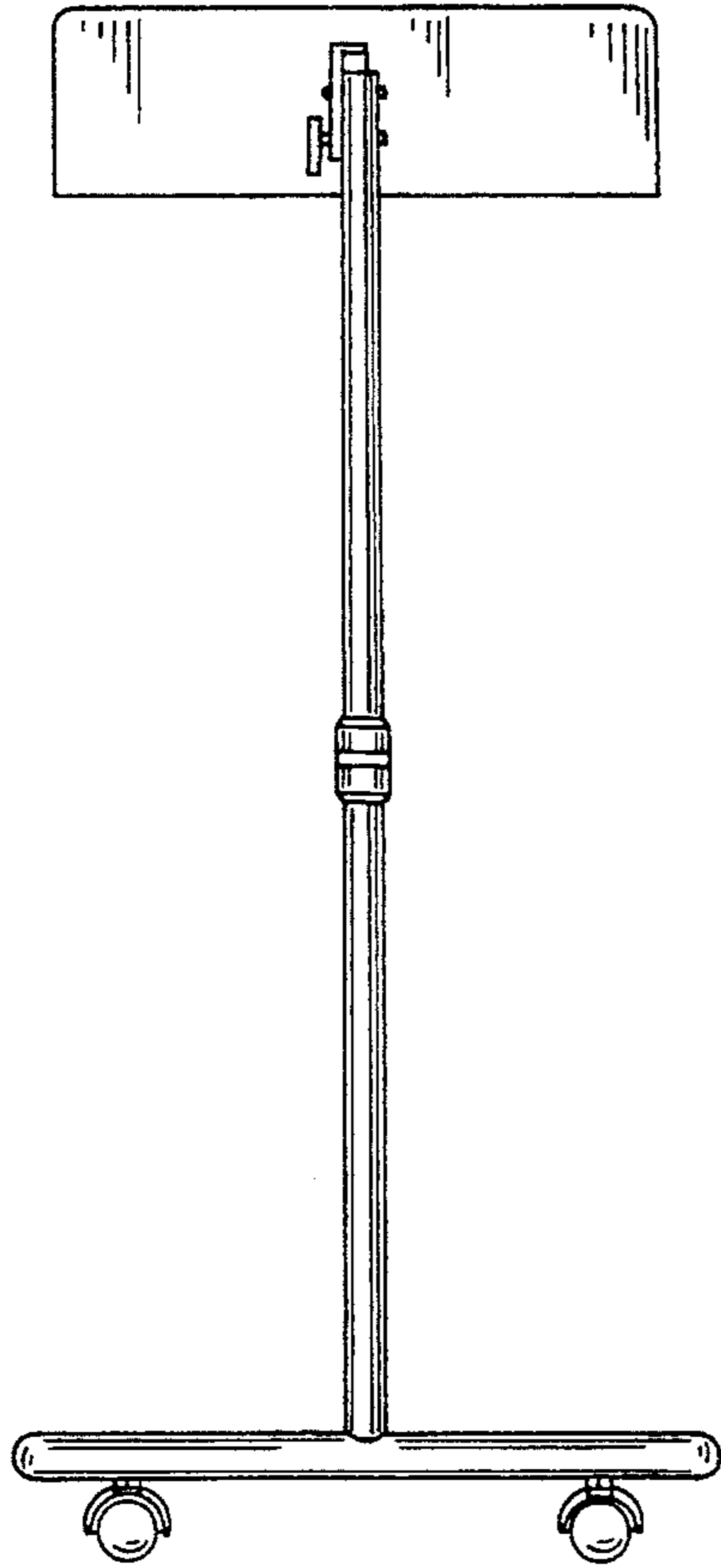

FIG. 3

FIG. 4

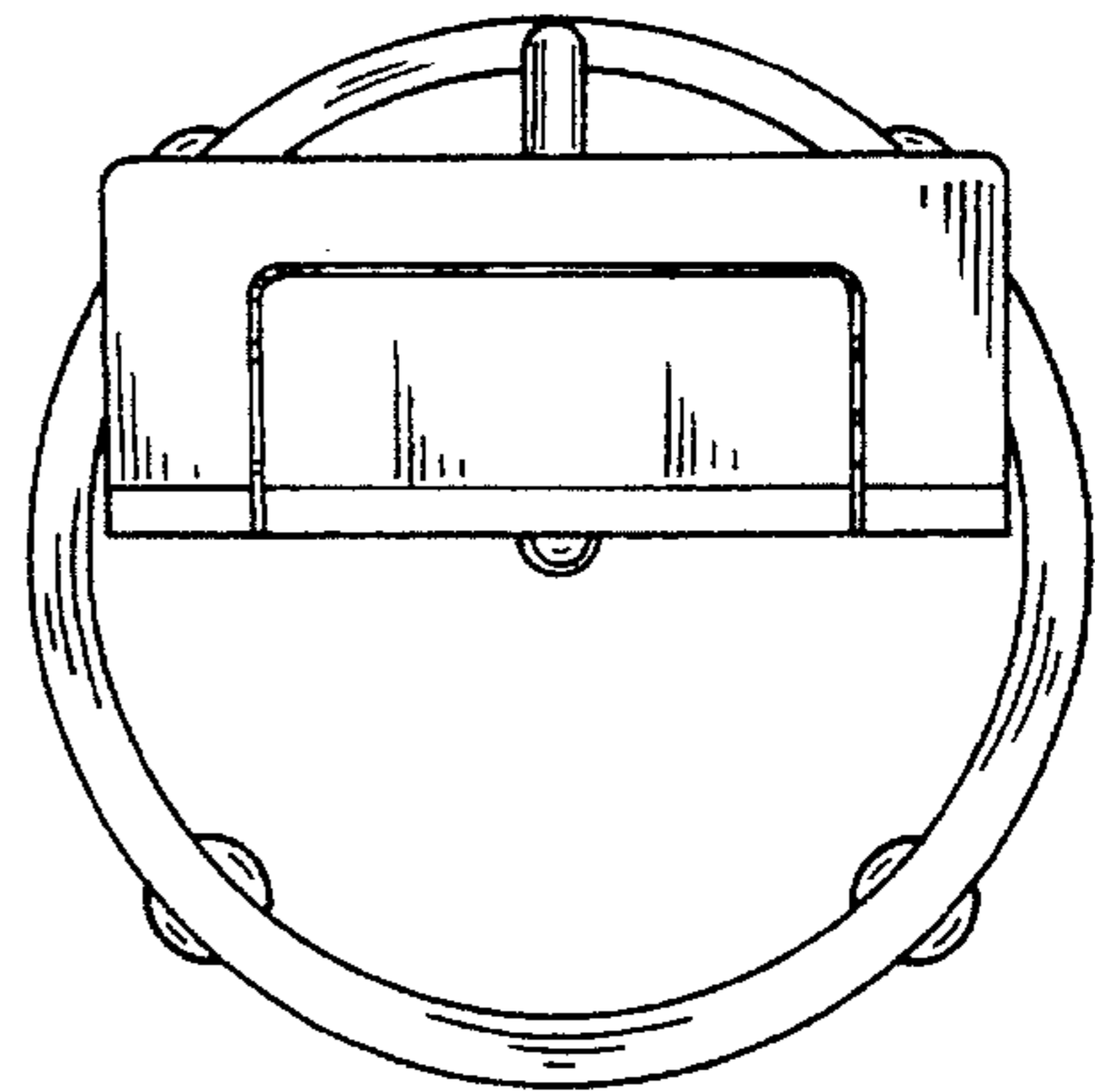
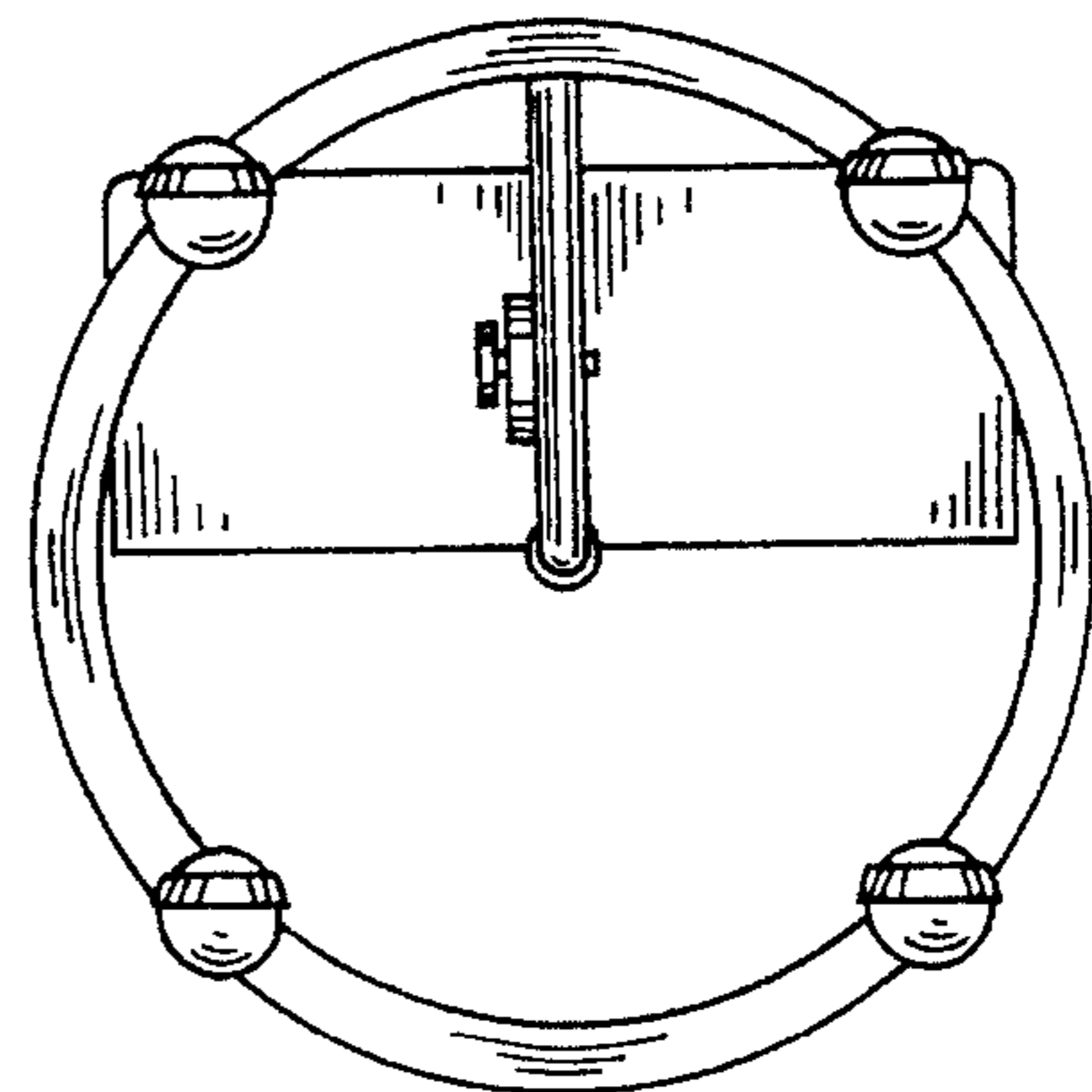

FIG. 5



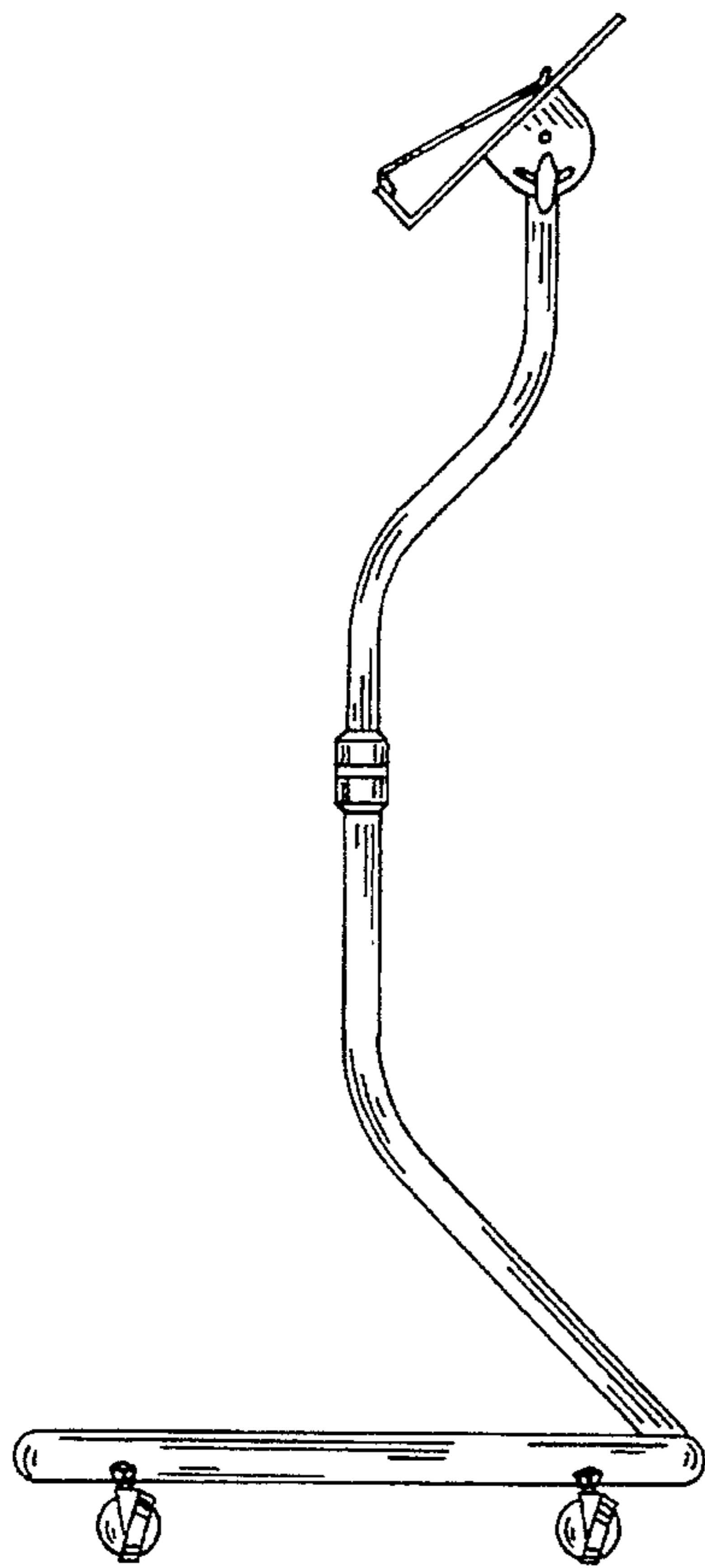

FIG. 6

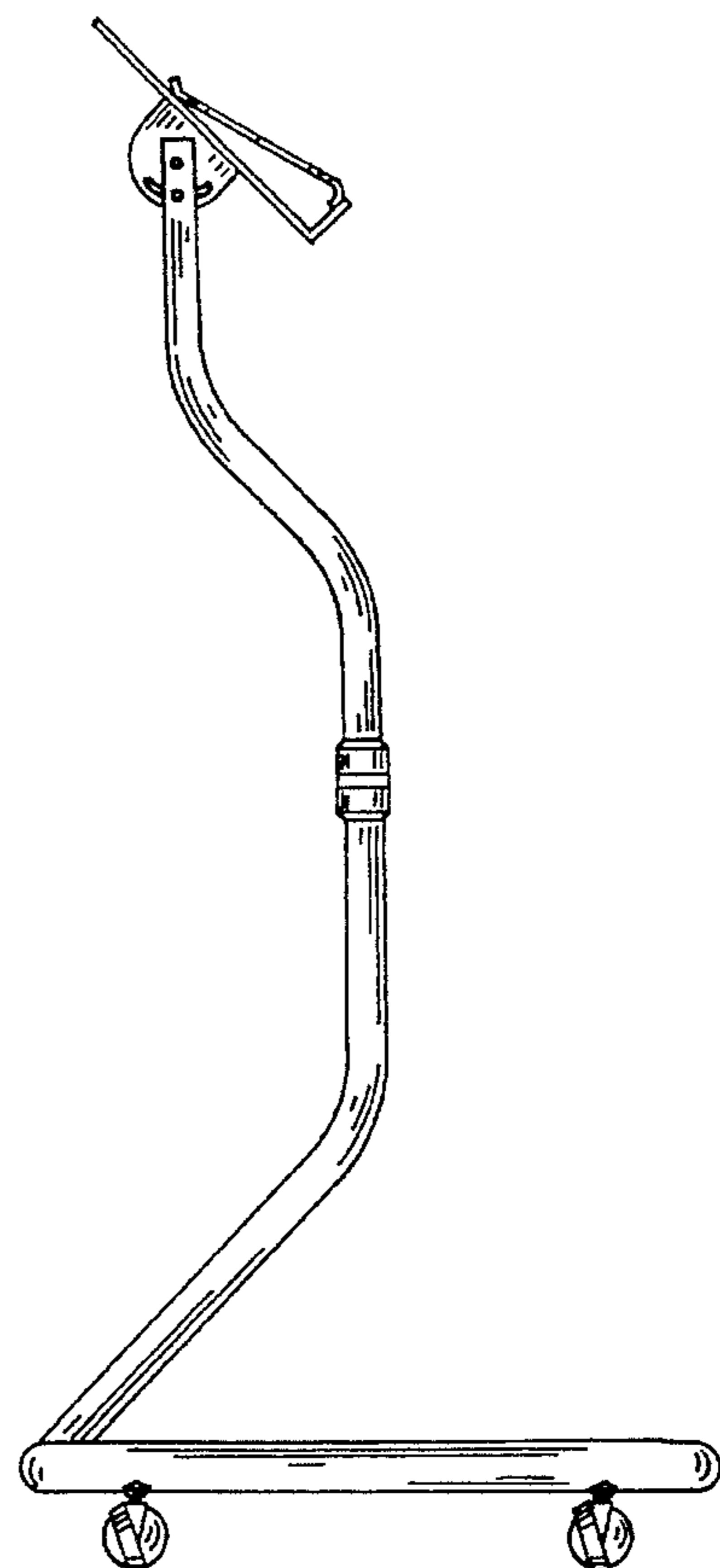

FIG. 7