



US00D377212S

United States Patent [19]
Moore

[11] **Patent Number:** **Des. 377,212**

[45] **Date of Patent:** ****Jan. 7, 1997**

[54] **VAPORIZER**

[75] Inventor: **Devin L. Moore**, Decatur, Ga.

[73] Assignee: **Sunbeam Products, Inc.**, Fort Lauderdale, Fla.

[**] Term: **14 Years**

[21] Appl. No.: **45,851**

[22] Filed: **Oct. 31, 1995**

[52] U.S. Cl. **D23/360; D23/356**

[58] **Field of Search** **D23/356-363;**
261/91, DIG. 65; D24/110; 392/333-337,
403-406

[56] **References Cited**

U.S. PATENT DOCUMENTS

D. 355,248 2/1995 Wang et al. **D23/356**

Primary Examiner—Lisa P. Lichtenstein

Attorney, Agent, or Firm—Michael J. Kline; Carol I. Bordas

[57] **CLAIM**

The ornamental design for a vaporizer, as shown.

DESCRIPTION

FIG. 1 is a top left front perspective view of a vaporizer showing my new design;

FIG. 2 is a top plan view thereof;

FIG. 3 is a bottom plan view thereof;

FIG. 4 is a front elevational view thereof;

FIG. 5 is a rear elevational view thereof;

FIG. 6 is a left side elevational view thereof; and,

FIG. 7 is a right side elevational view thereof.

1 Claim, 5 Drawing Sheets

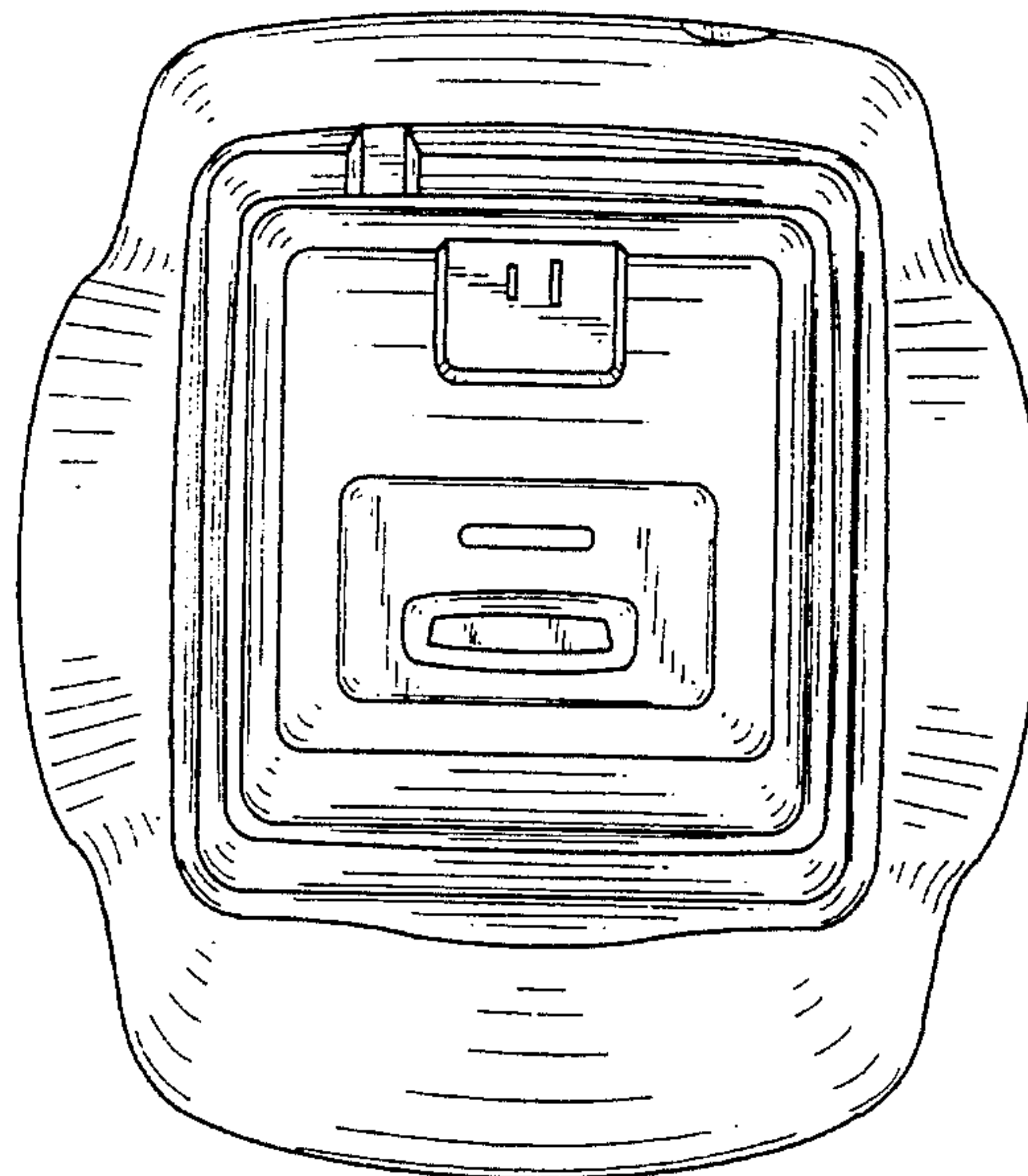
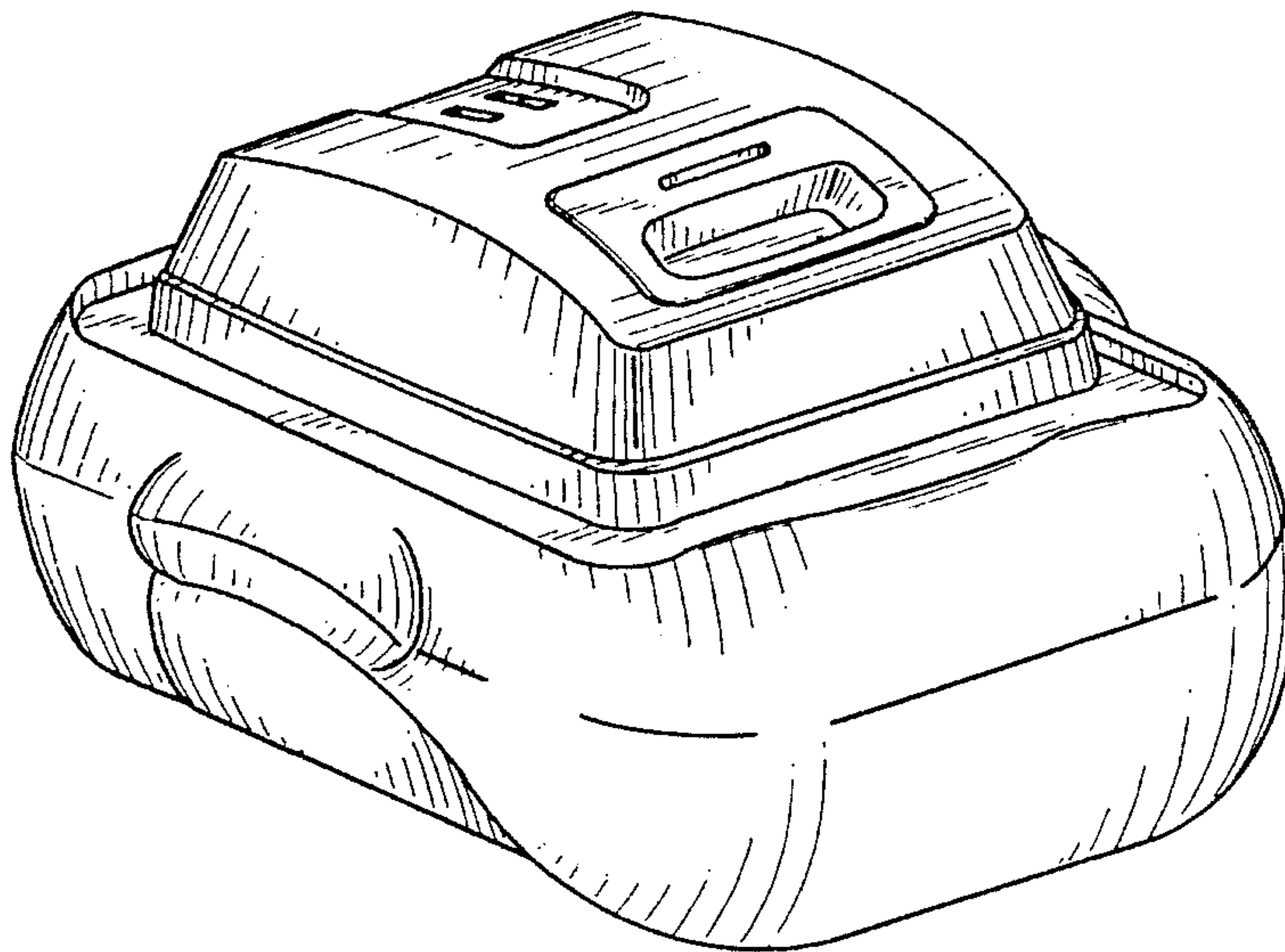

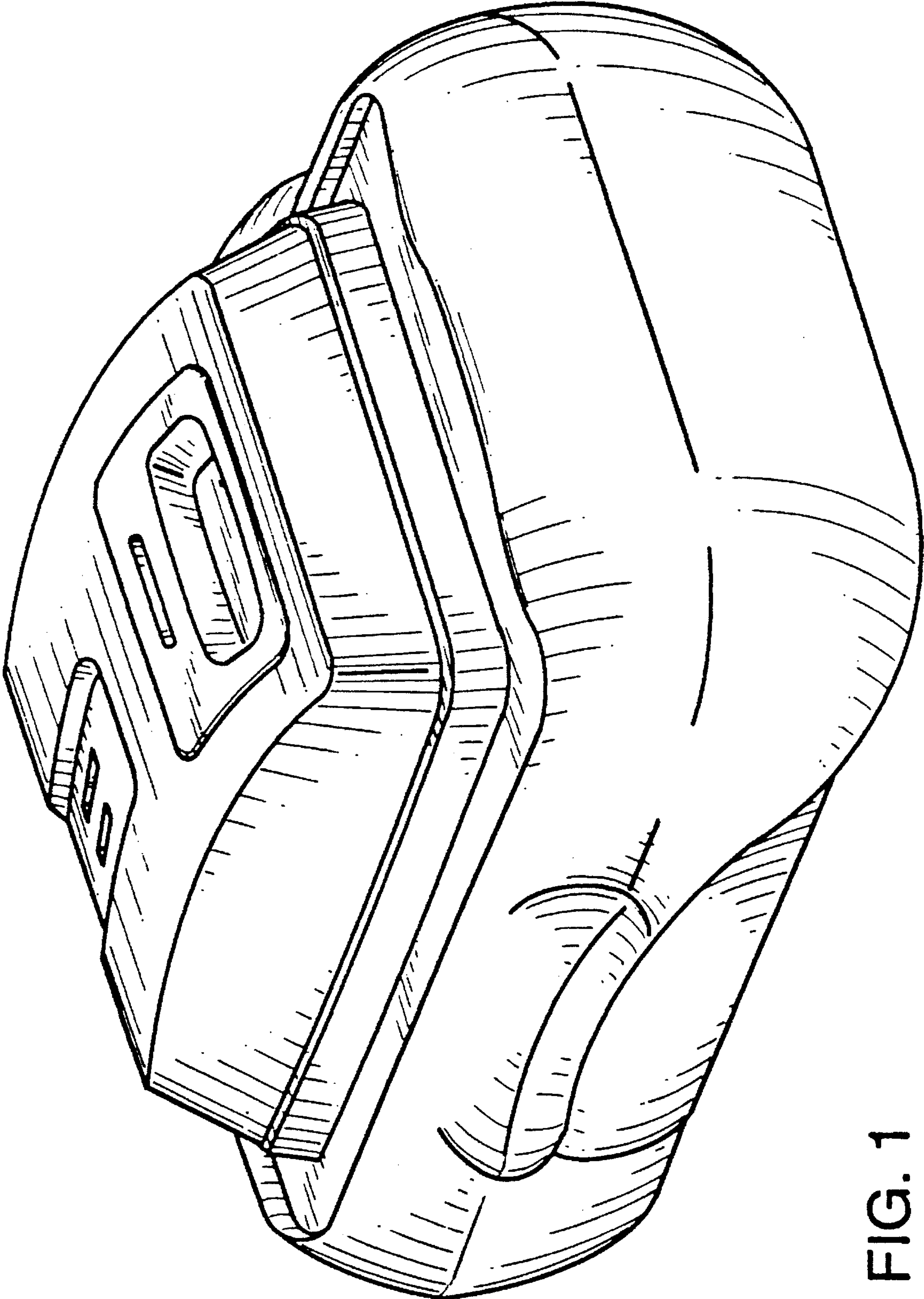

FIG. 1

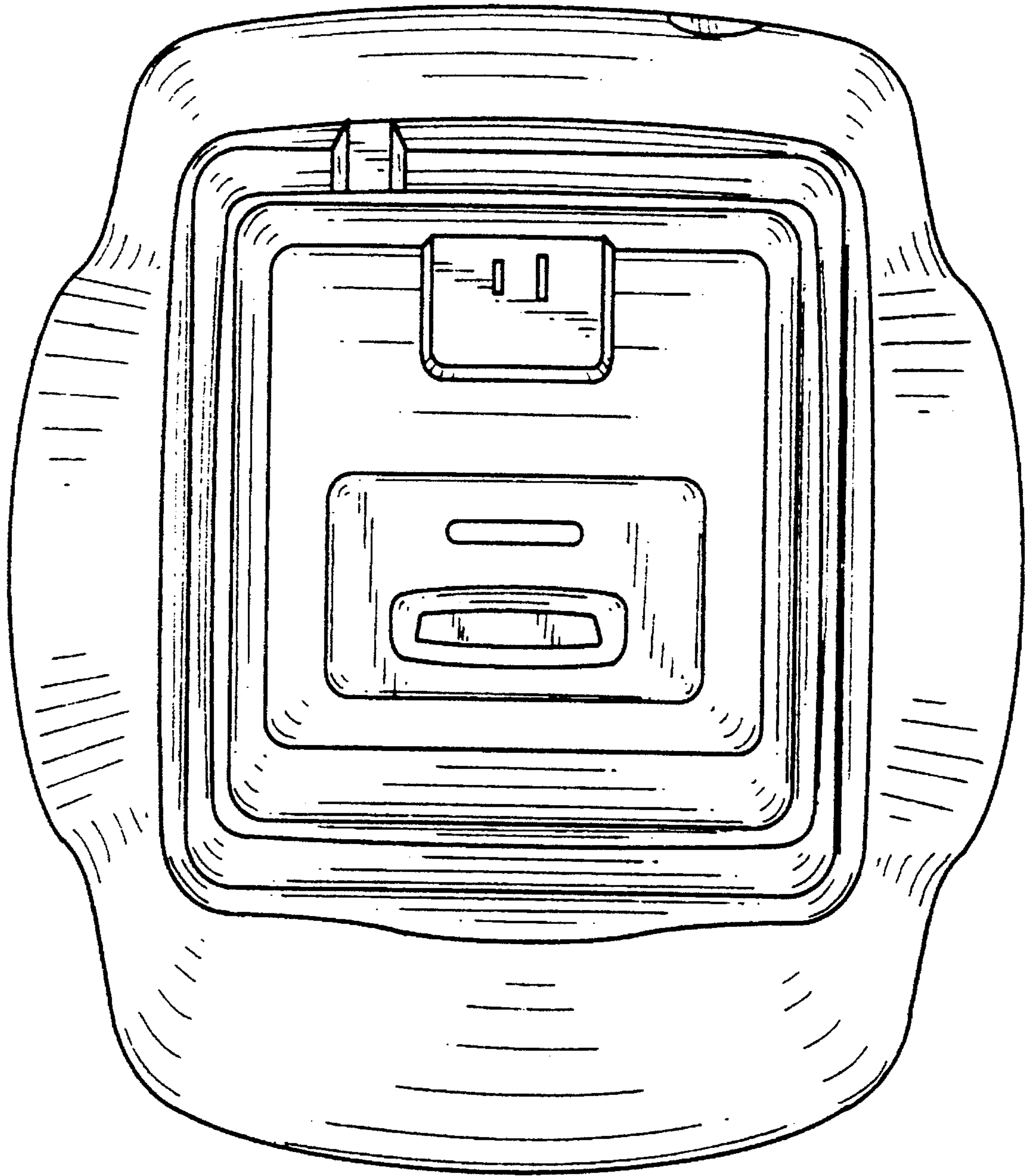

FIG. 2

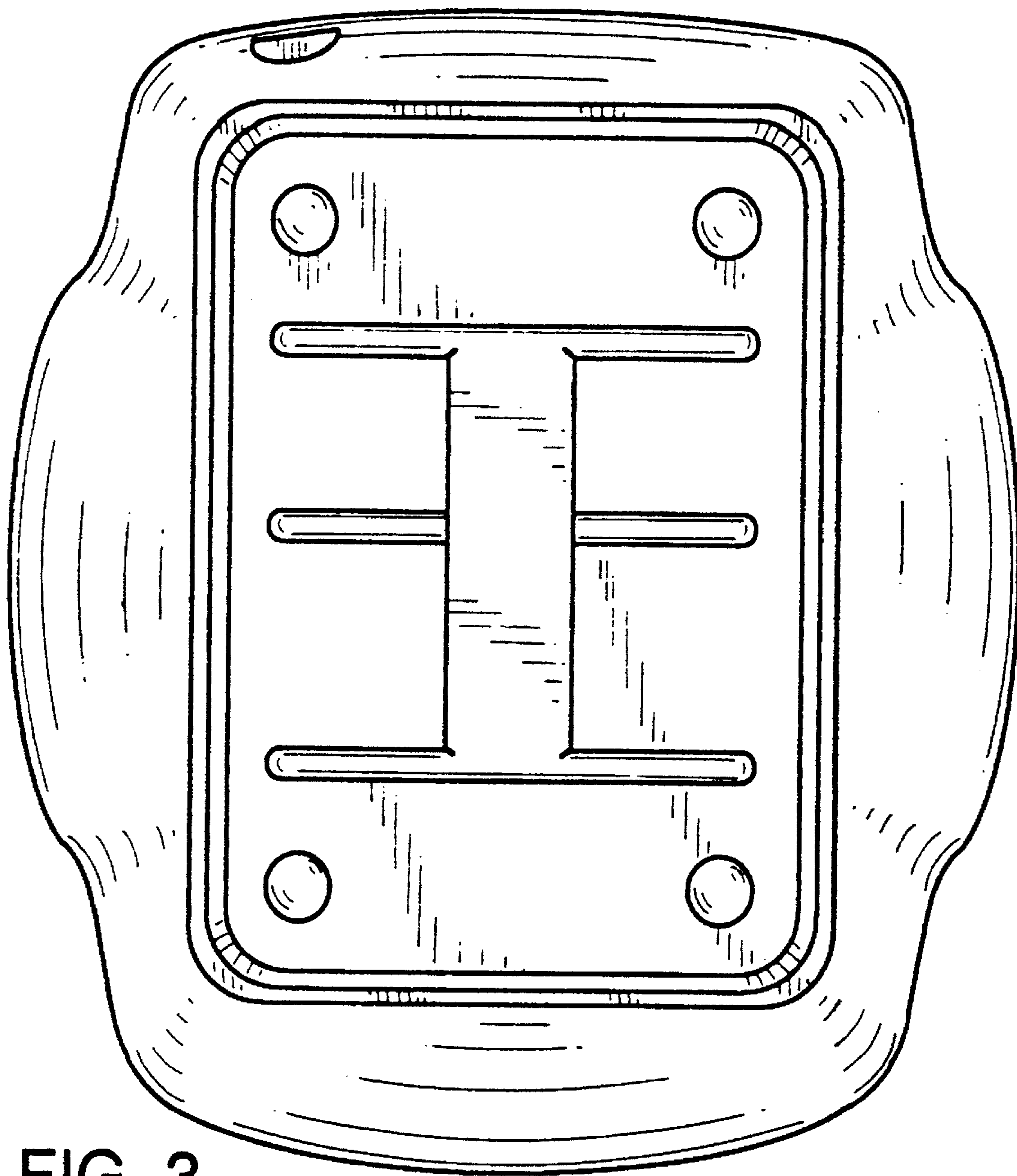

FIG. 3

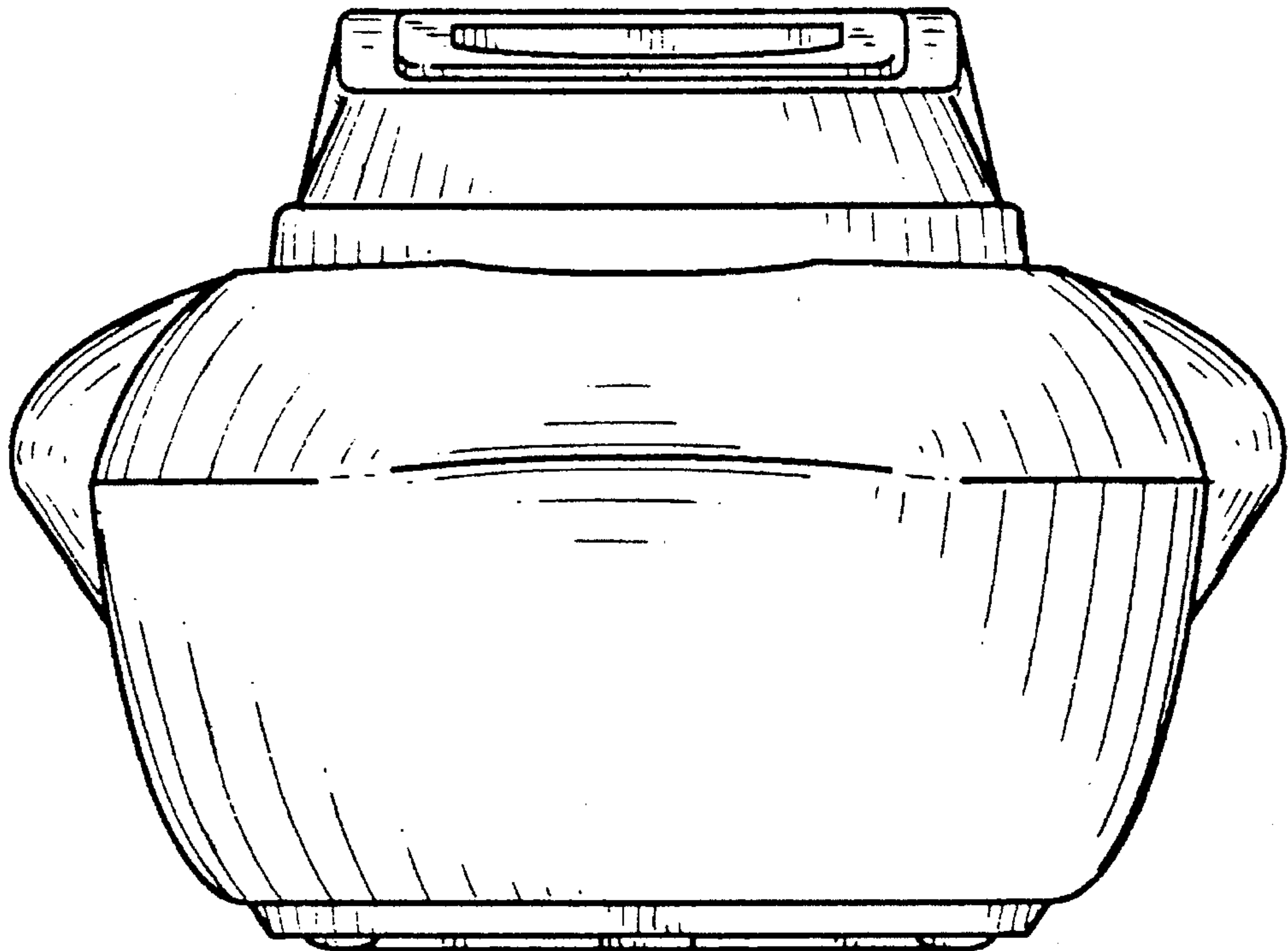

FIG. 4

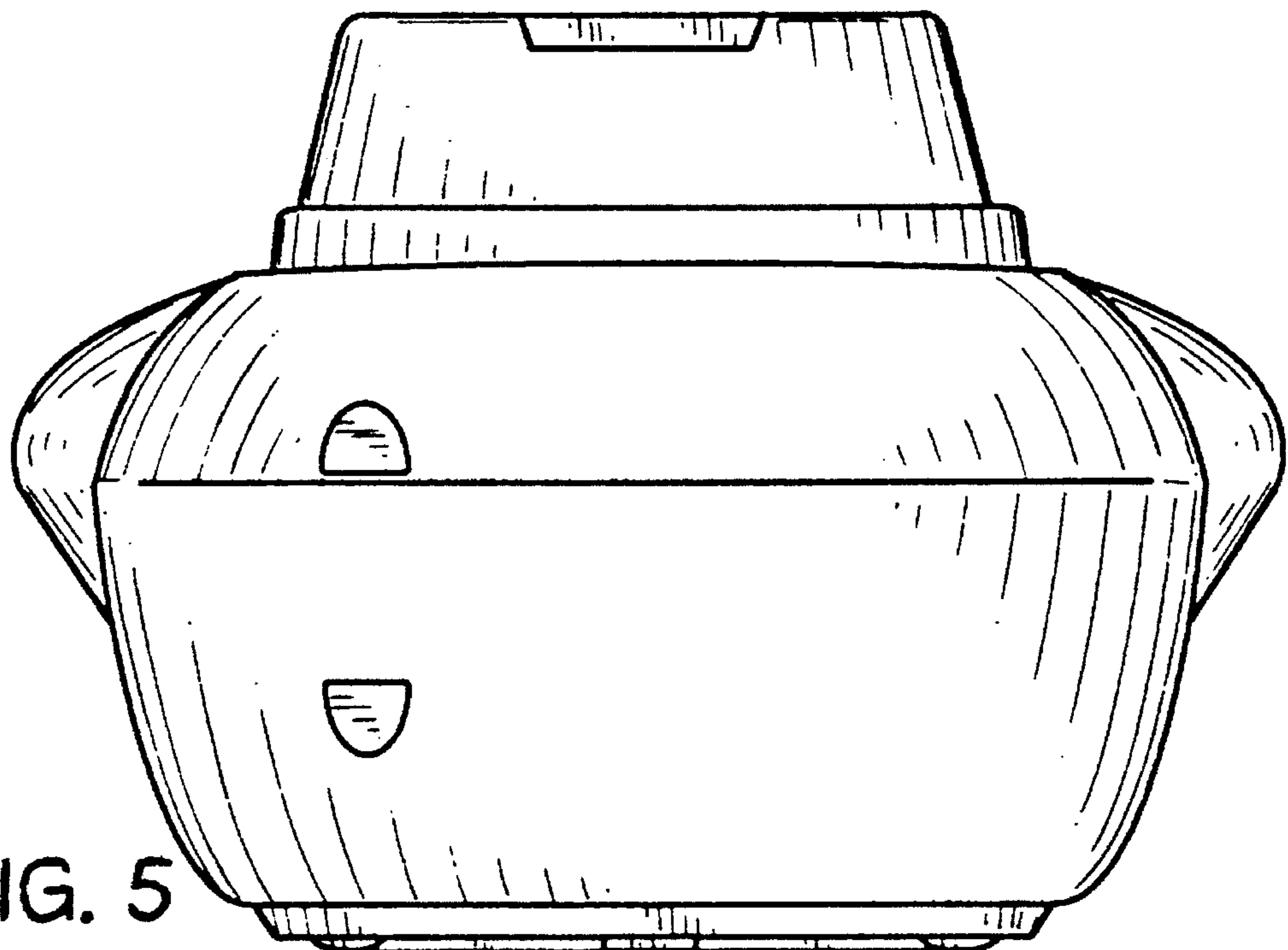

FIG. 5

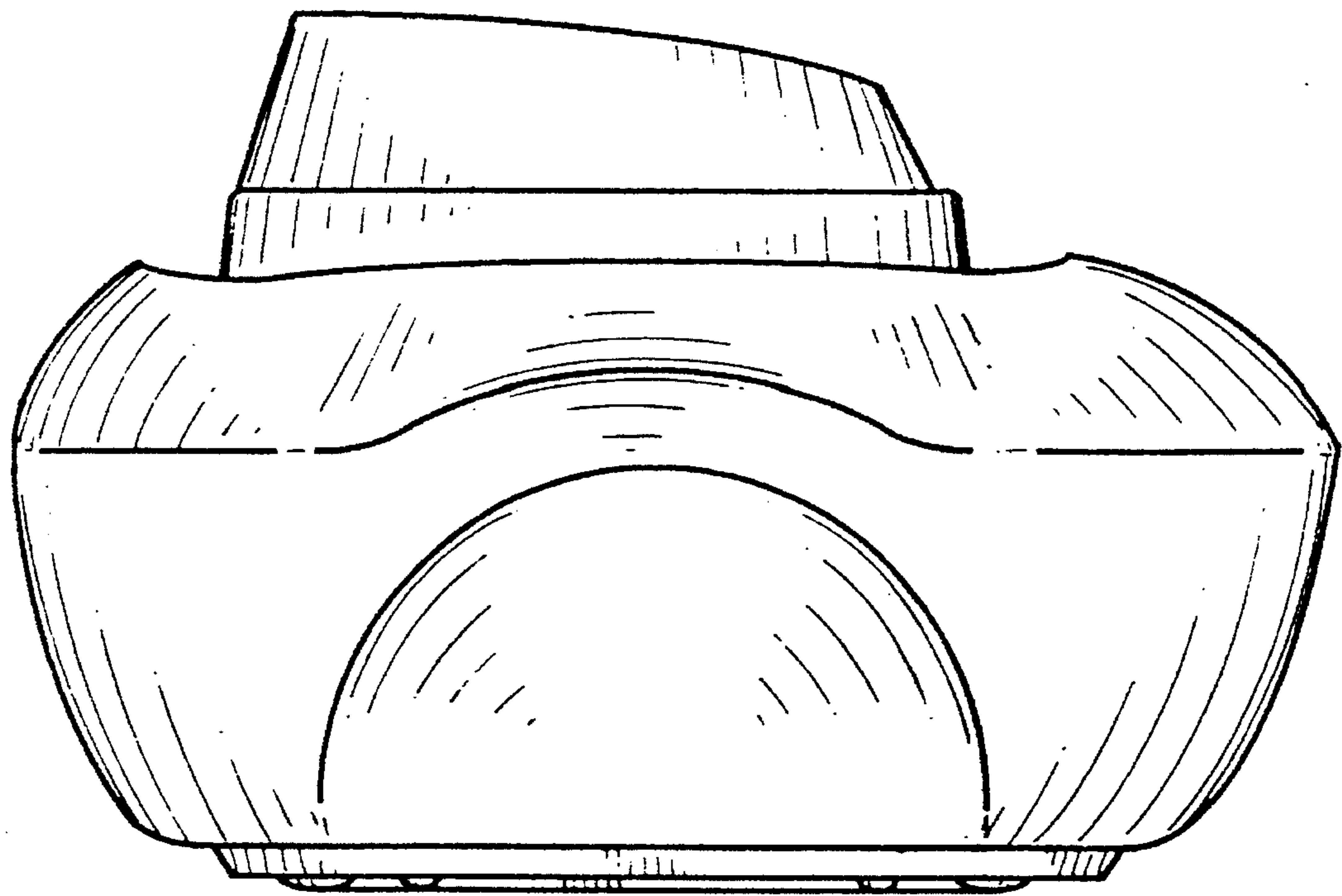

FIG. 6

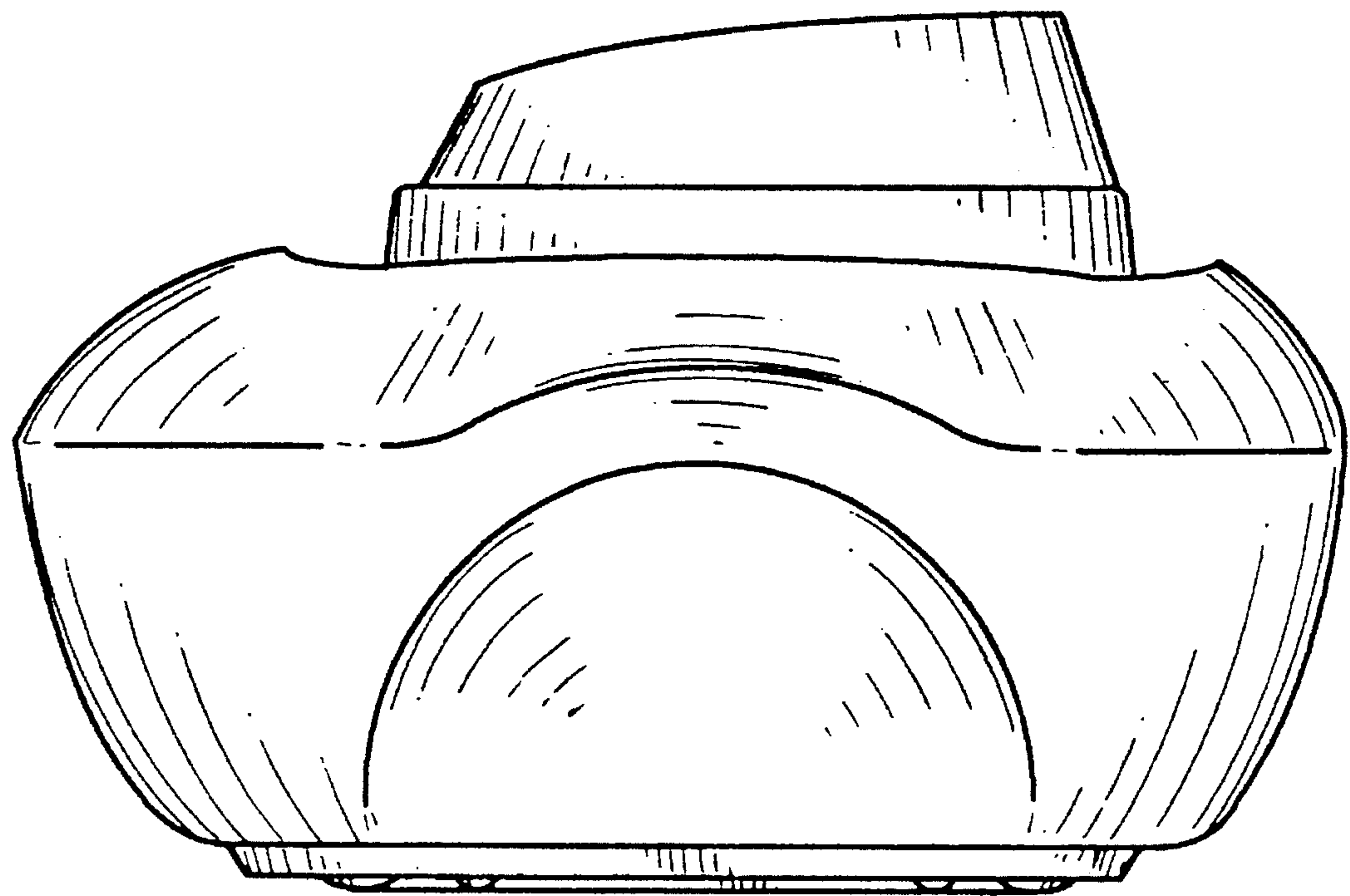

FIG. 7