



US00D377206S

**United States Patent** [19]  
**Tani**

[11] **Patent Number: Des. 377,206**

[45] **Date of Patent: \*\*Jan. 7, 1997**

[54] **URINAL**  
[75] Inventor: **Minoru Tani**, Kitakyushu, Japan  
[73] Assignee: **Toto Ltd.**, Fukuoka-Ken, Japan  
[\*\*] Term: **14 Years**

*Attorney, Agent, or Firm*—Birch, Stewart, Kolasch & Birch, LLP

[57] **CLAIM**

The ornamental design for a urinal, as shown and described.

**DESCRIPTION**

[21] Appl. No.: **50,845**  
[22] Filed: **Feb. 28, 1996**  
[52] **U.S. Cl.** ..... **D23/302**  
[58] **Field of Search** ..... D23/274, 295-302,  
D23/309-313; 4/301-311

FIG. 1 is a front perspective view of a urinal showing my new design;  
FIG. 2 is a front elevational view thereof;  
FIG. 3 is a right side elevational view thereof, the left side elevational view being a mirror image thereof;  
FIG. 4 is a top plan view thereof;  
FIG. 5 is a rear elevational view thereof;  
FIG. 6 is a cross-sectional view taken along line VI—VI of FIG. 2;  
FIG. 7 is a cross-sectional view taken along line VII—VII of FIG. 2;  
FIG. 8 is a cross-sectional view taken along line VIII—VIII of FIG. 2;  
FIG. 9 is a cross-sectional view taken along line IX—IX of FIG. 2; and,  
FIG. 10 is a cross-sectional view taken along line X—X of FIG. 2.

[56] **References Cited**

**U.S. PATENT DOCUMENTS**

D. 195,080	4/1963	Phillips	.....	D23/302
D. 208,291	8/1967	McRutosh	.....	D23/302
D. 294,966	3/1988	Konler, Jr. et al.	.....	D23/302
D. 331,960	12/1992	Alger	.....	D23/302

**OTHER PUBLICATIONS**

Toto '92-'93 General Catalog, pp. 138-139 (Jun. 1992).

*Primary Examiner*—Stella Reid  
*Assistant Examiner*—Eric Waterson

**1 Claim, 5 Drawing Sheets**

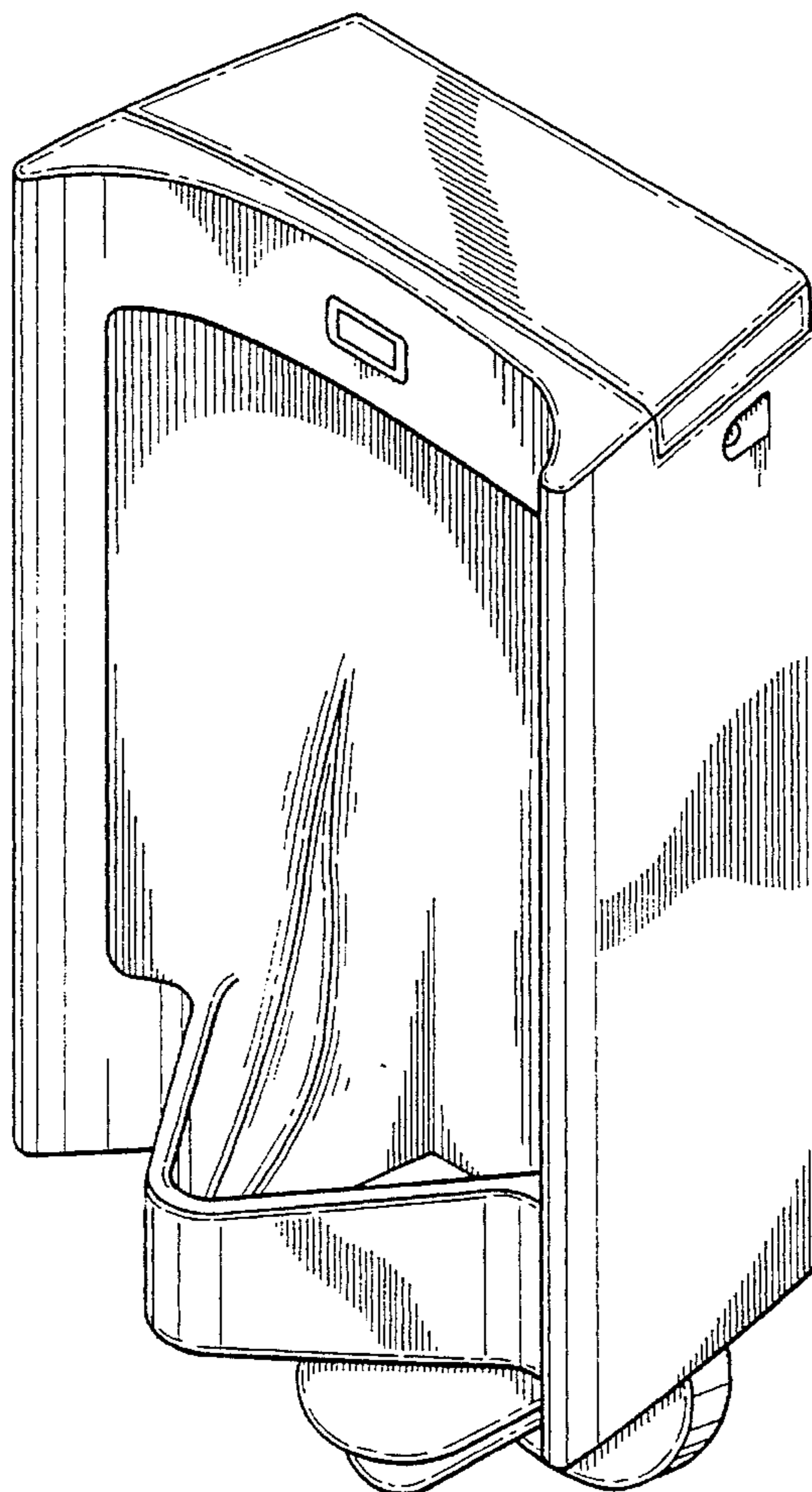

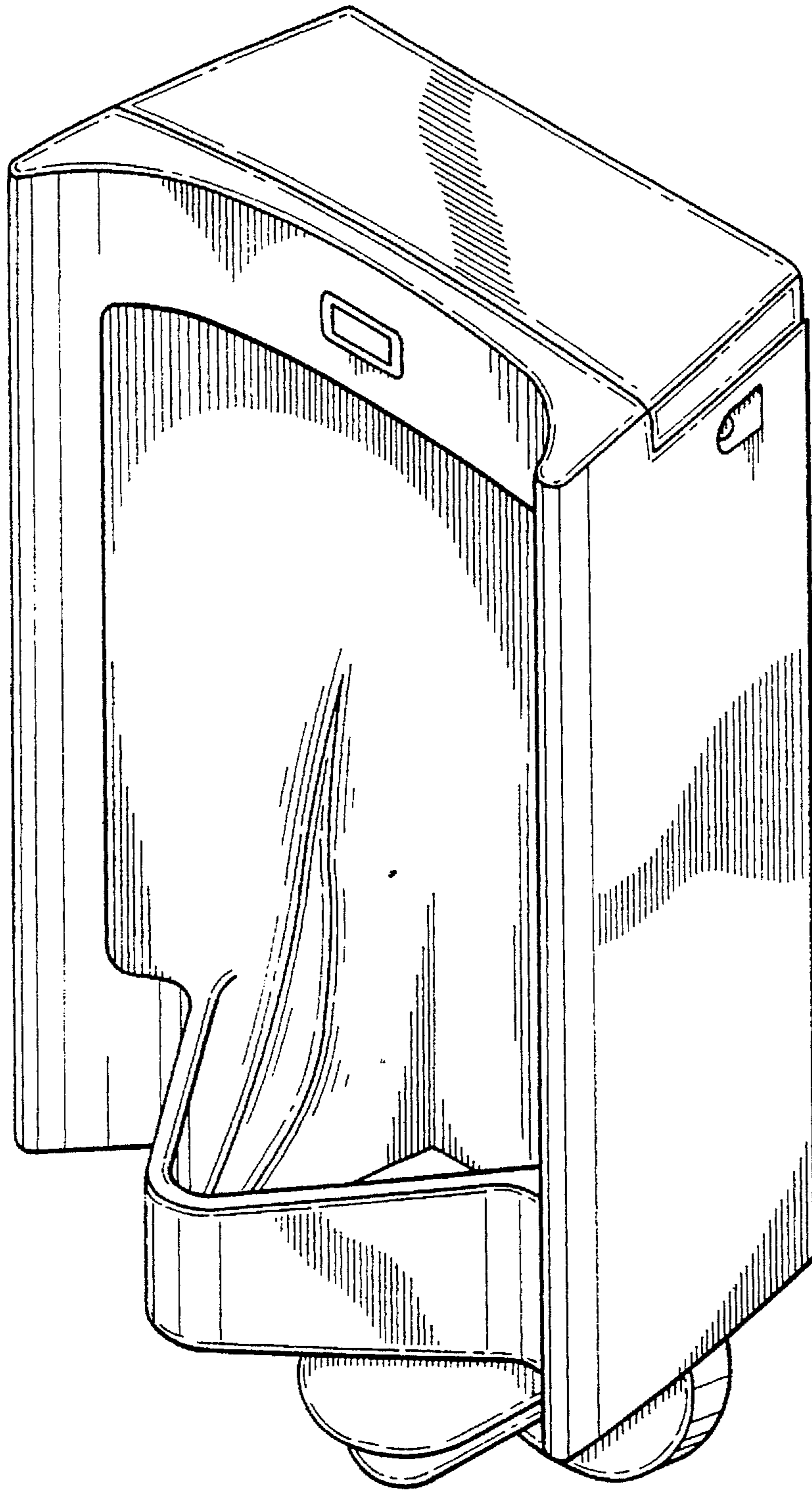

FIG. 1

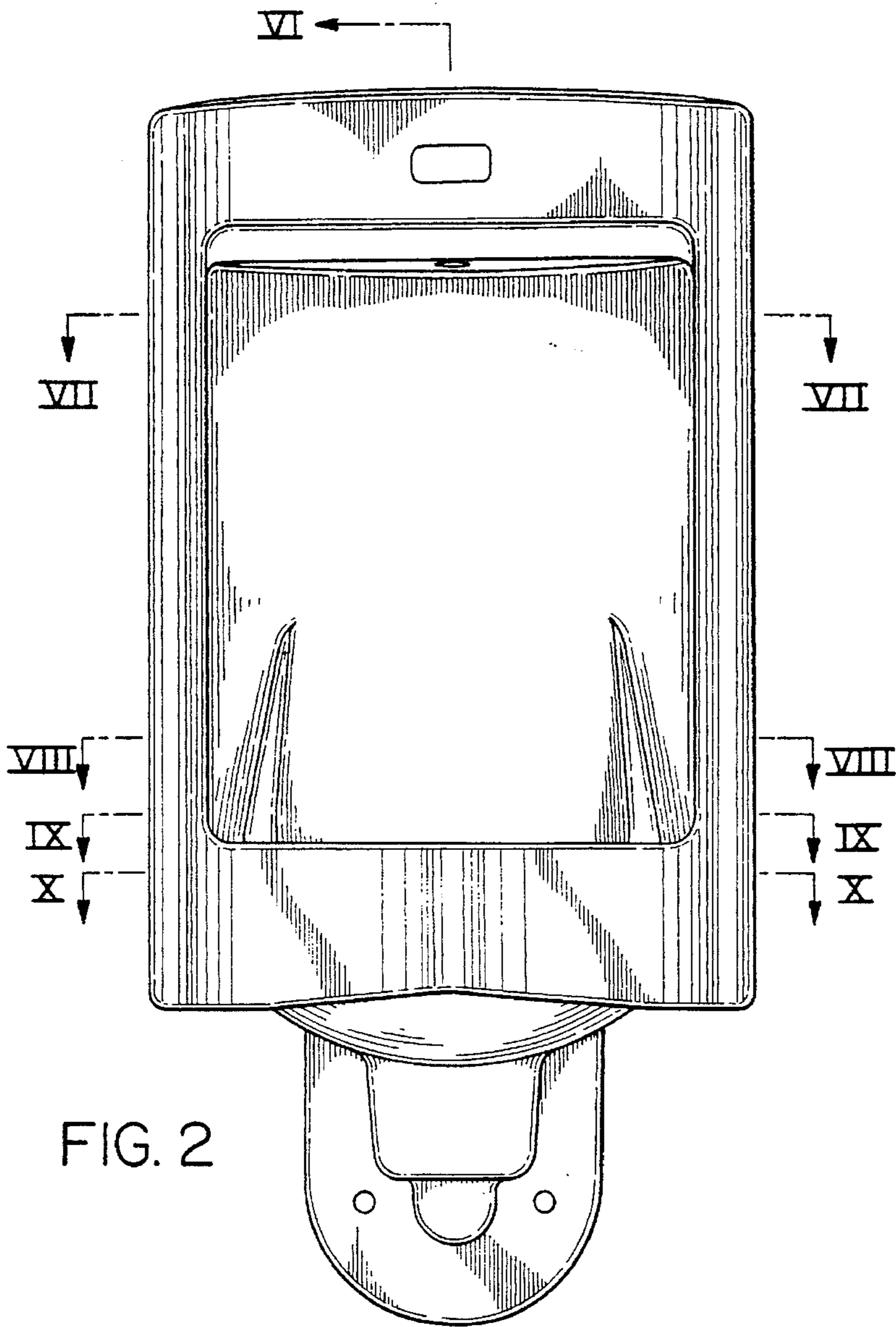
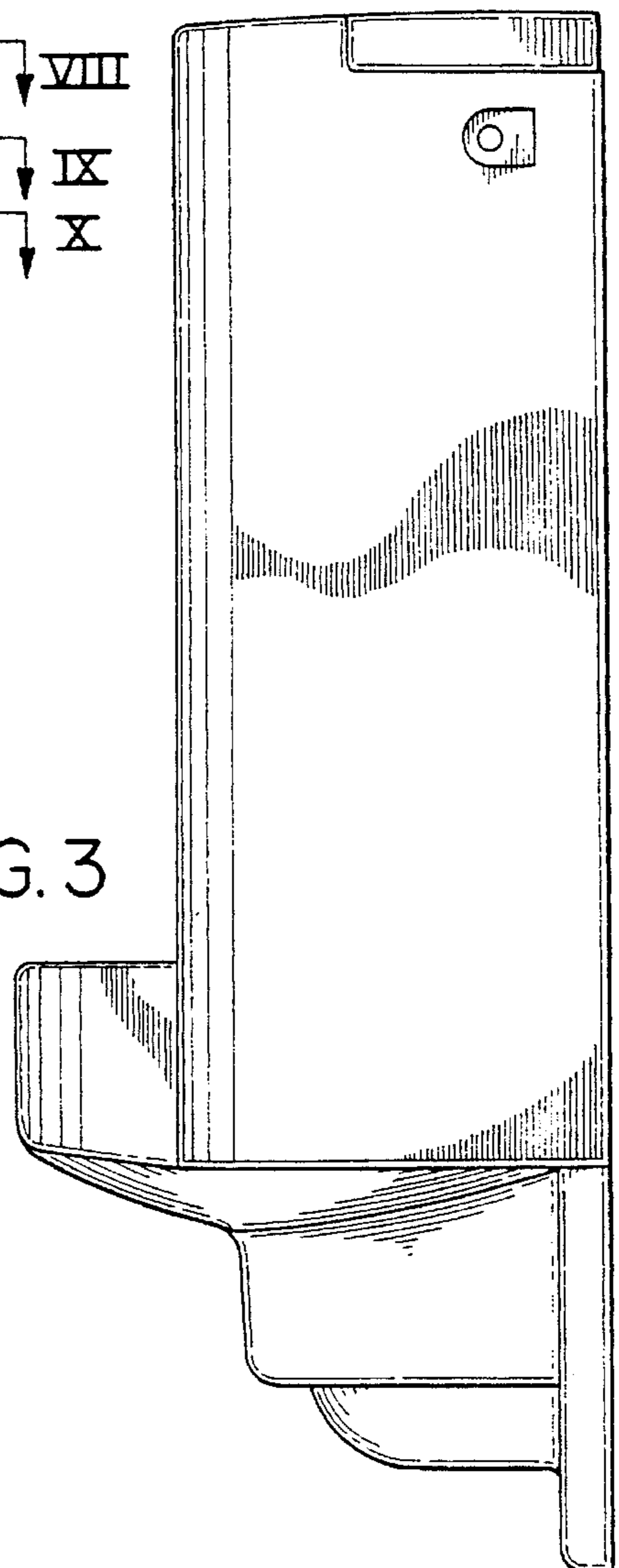

FIG. 2



FIG. 3



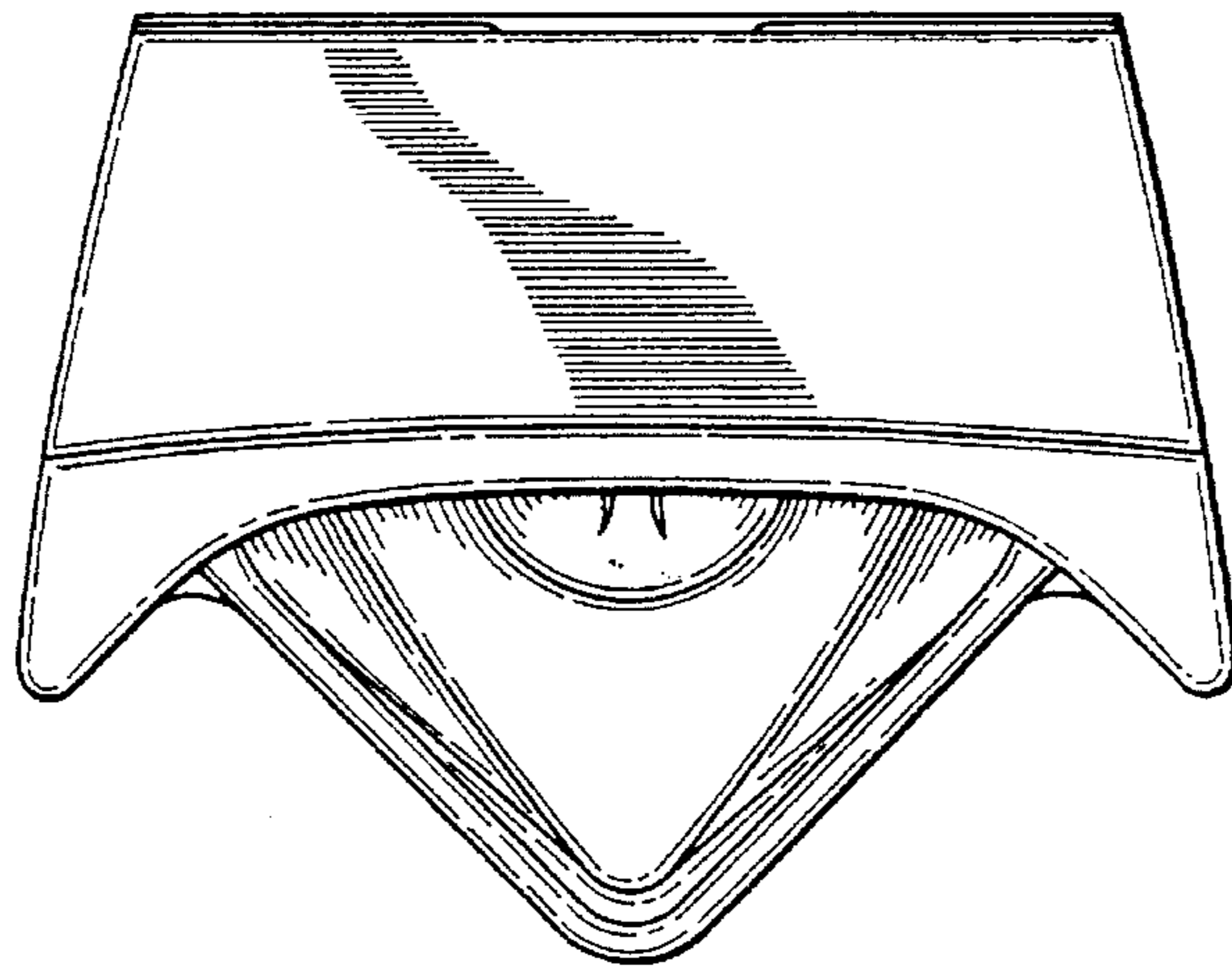

FIG. 4

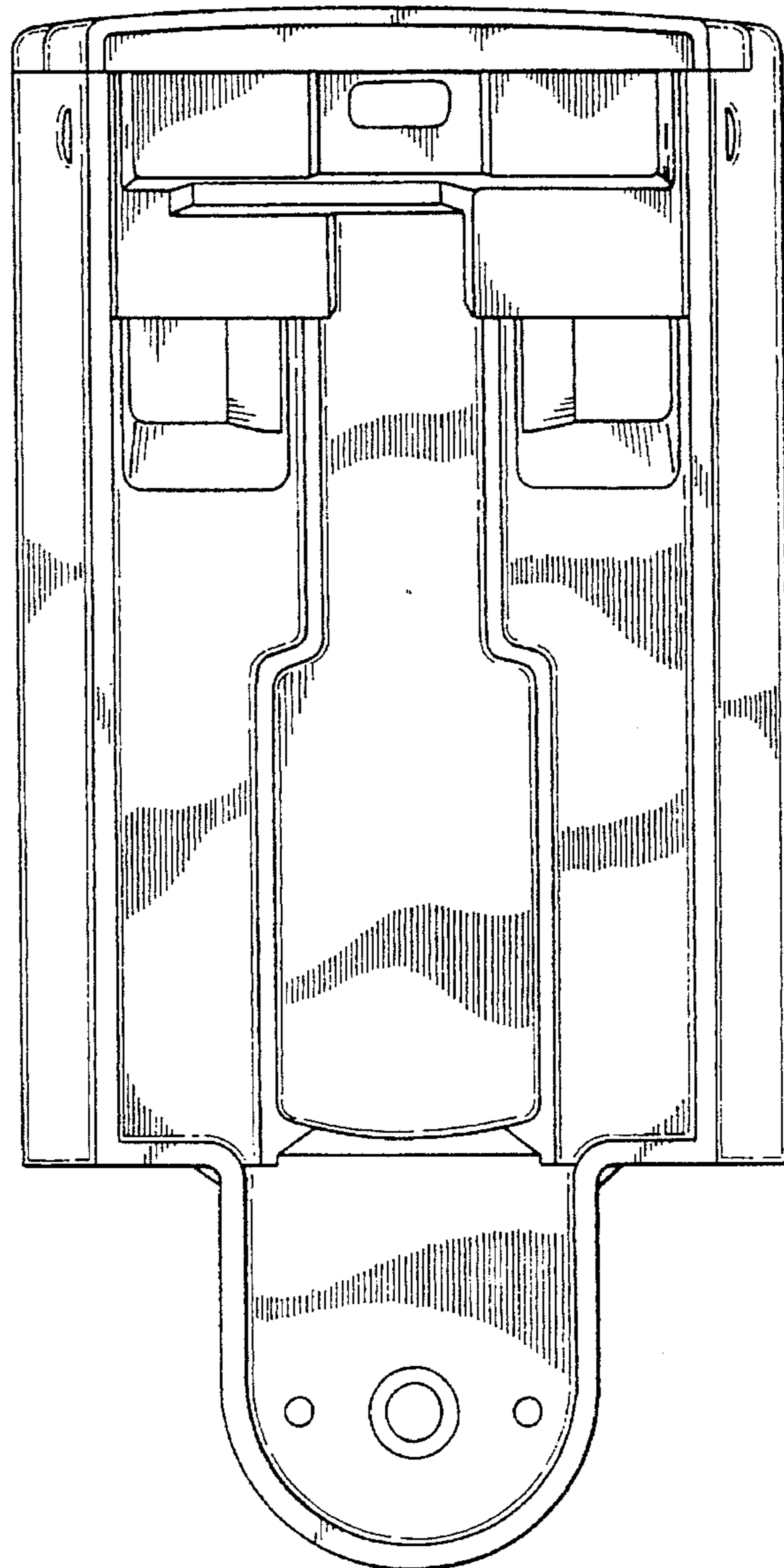

FIG. 5

FIG. 6

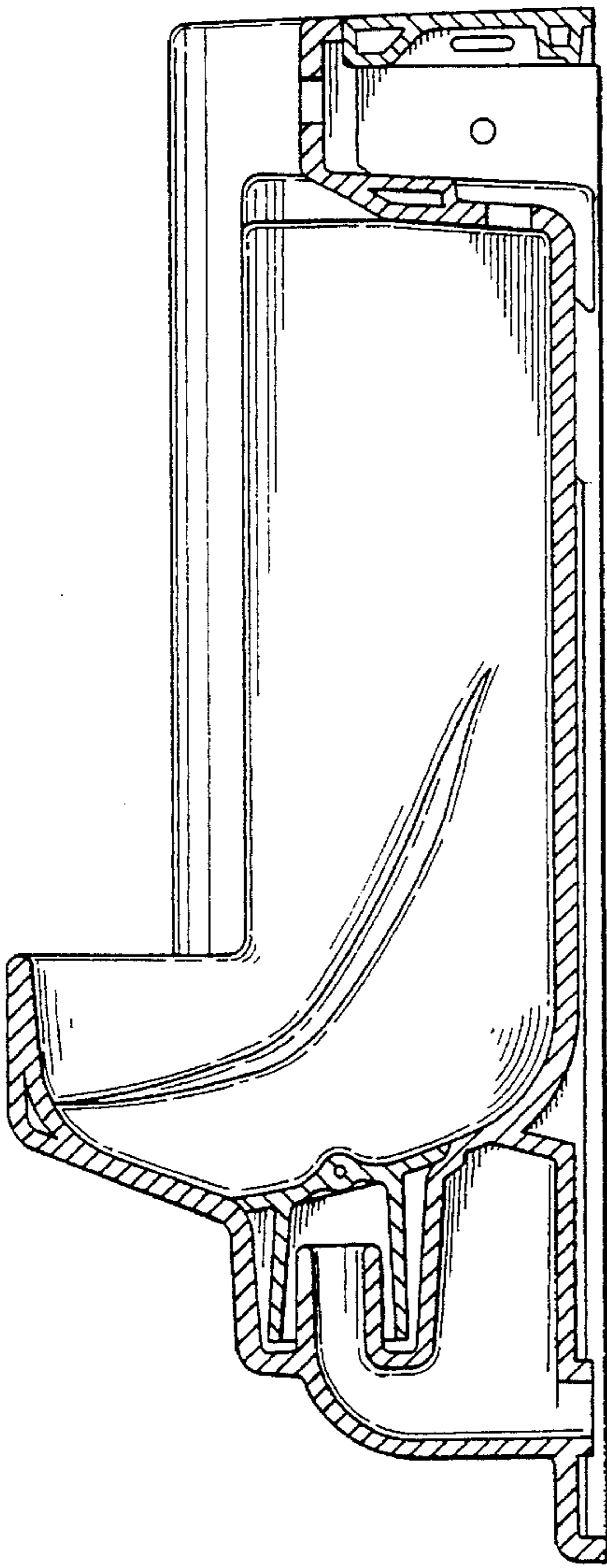

FIG. 7

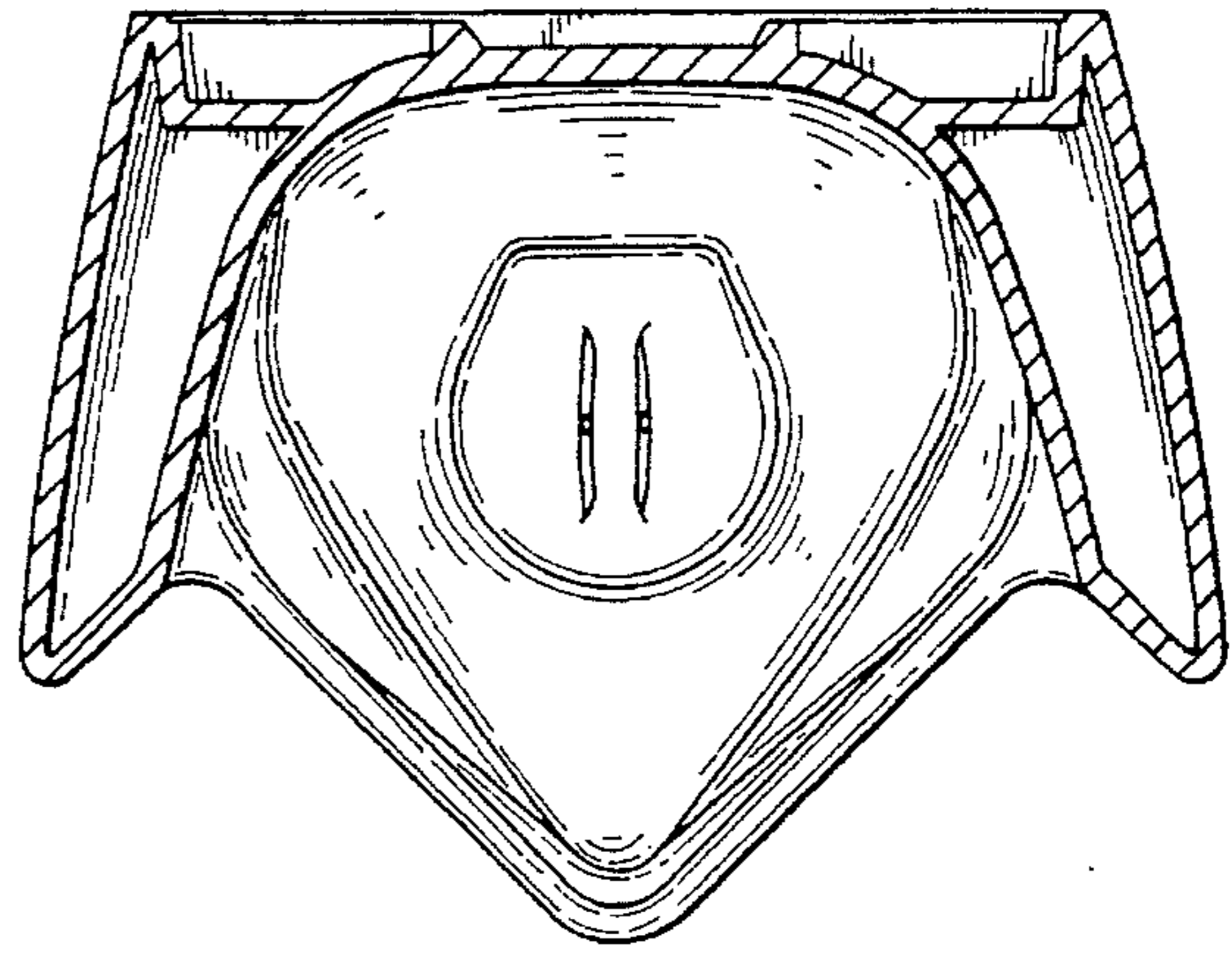

FIG. 8

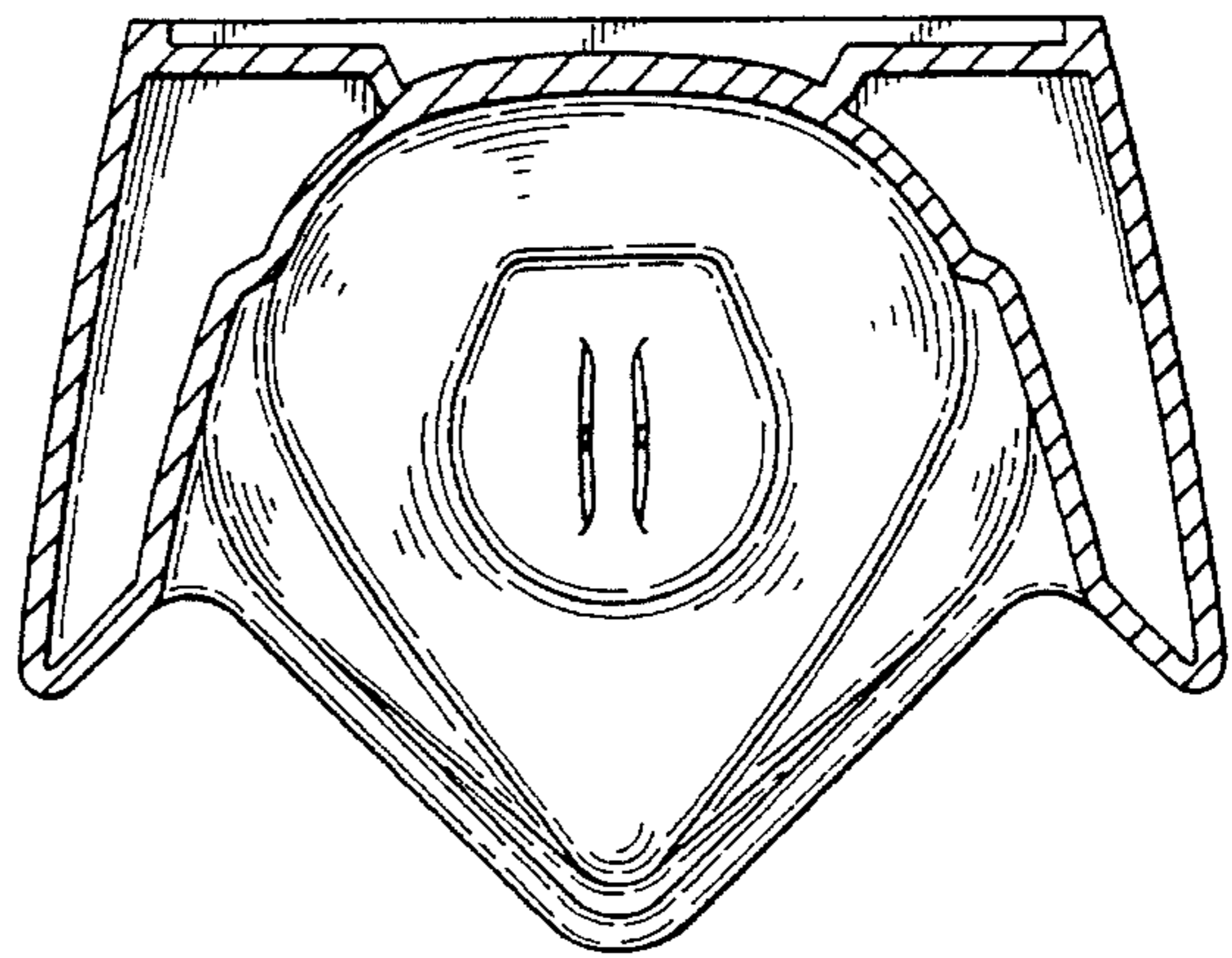

FIG. 9

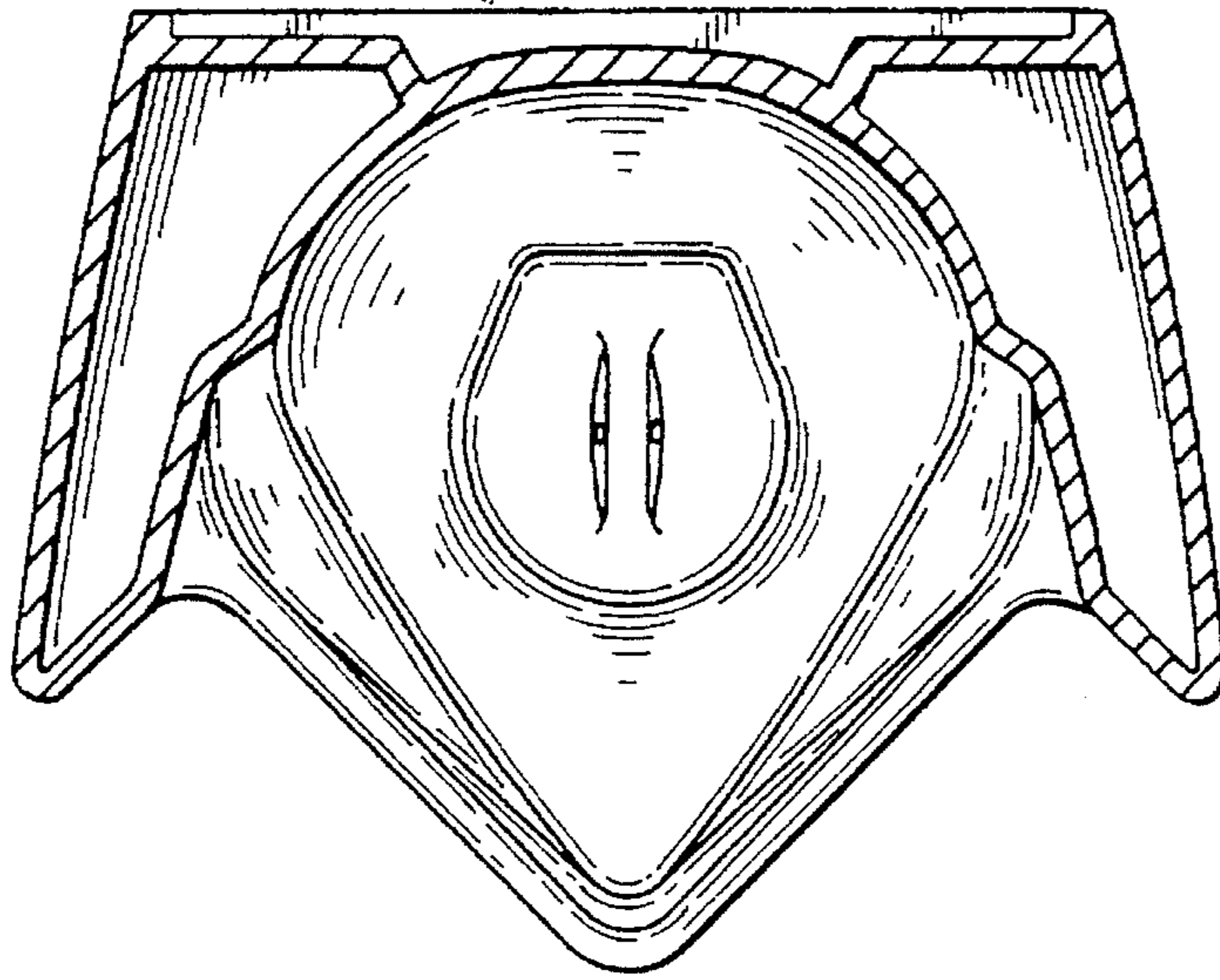

FIG. 10

