



US00D377189S

United States Patent [19]

[11] Patent Number: **Des. 377,189**

Komuta et al.

[45] Date of Patent: ****Jan. 7, 1997**

[54] **ELECTRONIC CALCULATOR HAVING THE FUNCTIONS OF TELEPHONE BOOK, ADDRESS BOOK, CALENDAR, SCHEDULE BOOK AND MEMO BOOK**

D. 362,865 10/1995 Komuta et al. D18/2

[75] Inventors: **Yoshihiro Komuta**, Sagamihara; **Yuiti Kurabuti**, Kasukabe, both of Japan

Primary Examiner—James M. Gandy
Assistant Examiner—Caron D. Veynar
Attorney, Agent, or Firm—Frishauf, Holtz, Goodman, Langer & Chick

[73] Assignee: **Casio Computer Co., Ltd.**, Tokyo, Japan

[57] CLAIM

[**] Term: **14 Years**

The ornamental design for an electronic calculator having the functions of the telephone book, address book, calendar, schedule book and memo book, as shown and described.

[21] Appl. No.: **48,432**

DESCRIPTION

[22] Filed: **Dec. 28, 1995**

[52] U.S. Cl. **D18/2; D14/100; D18/7**

[58] **Field of Search** D18/1, 2, 6, 7, D18/11, 12; D14/100, 106, 115; 340/700, 706; 364/706-710; 200/5 A; 235/61 R

FIG. 1 is a front elevational view of an electronic calculator having the functions of telephone book, address book, calendar, schedule book and memo book showing our new design;

FIG. 2 is a right side elevational view thereof;

FIG. 3 is a left side elevational view thereof;

FIG. 4 is a top plan view thereof;

FIG. 5 is a bottom plan view thereof;

FIG. 6 is a rear elevational view thereof;

FIG. 7 is a perspective view thereof;

FIG. 8 is a front elevational view thereof with the cover open; and,

FIG. 9 is a rear elevational view thereof with the cover open.

[56] References Cited

U.S. PATENT DOCUMENTS

D. 341,573	11/1993	Sakaguchi et al.	D18/7 X
D. 345,732	4/1994	Sakaguchi et al.	D18/7 X
D. 351,853	10/1994	Ido	D18/7
D. 353,827	12/1994	Shigemura et al.	D18/2
D. 354,046	1/1995	Sakaguchi et al.	D14/100
D. 362,672	9/1995	Komuta	D18/2

1 Claim, 3 Drawing Sheets

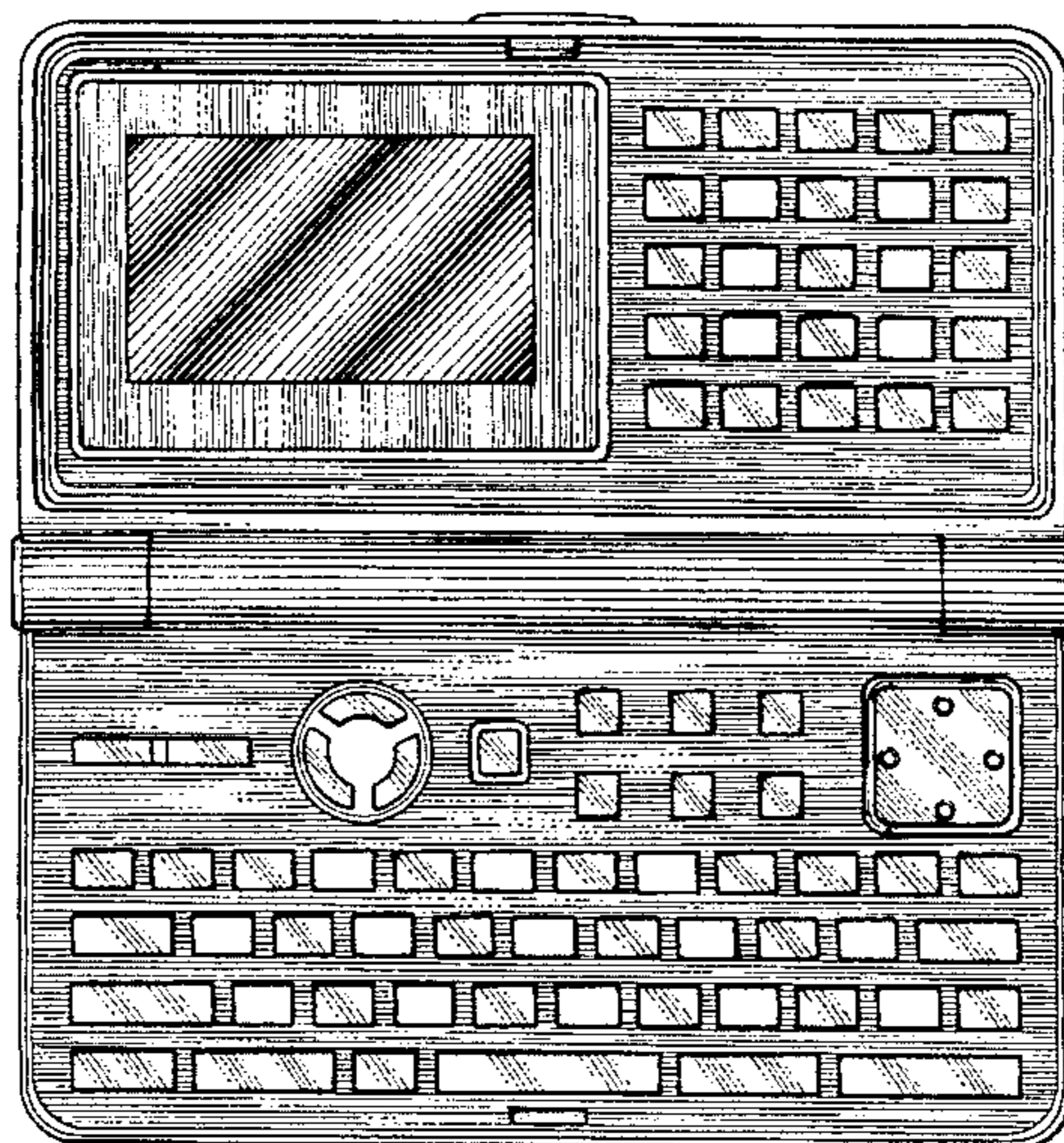
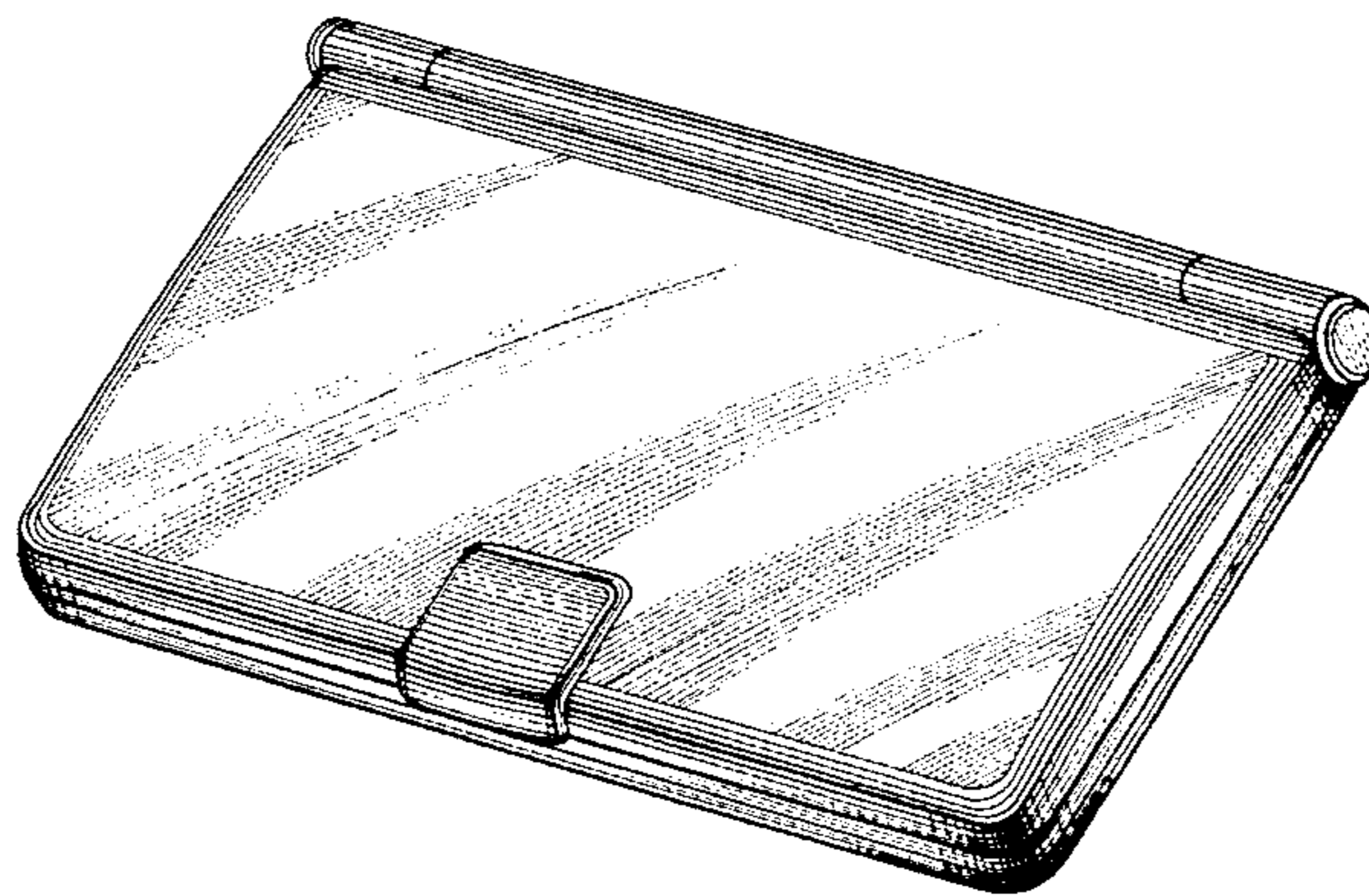

FIG. 4

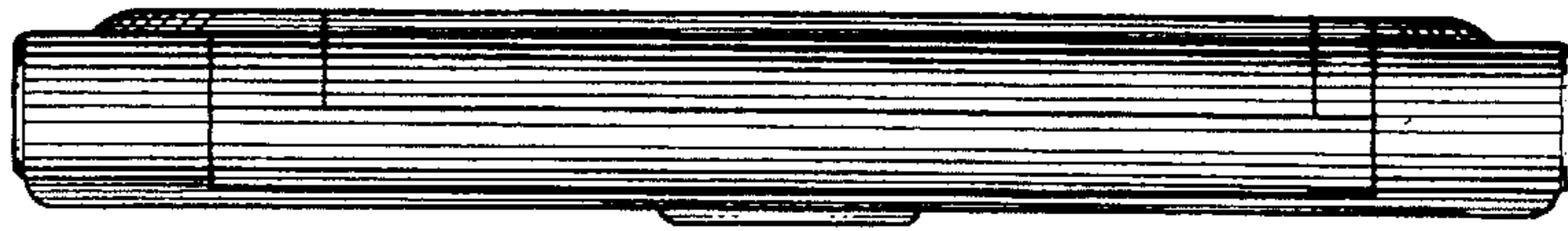

FIG. 3

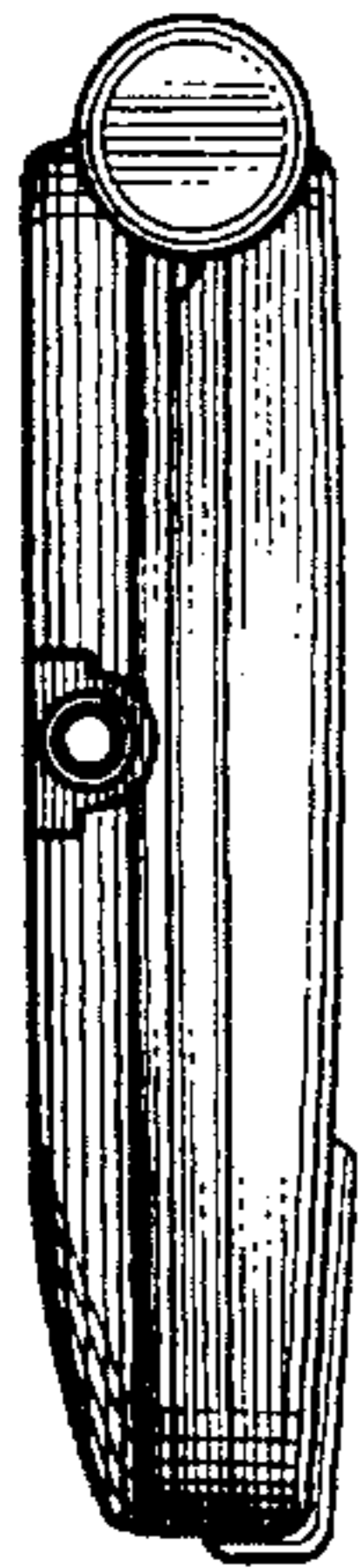

FIG. 1

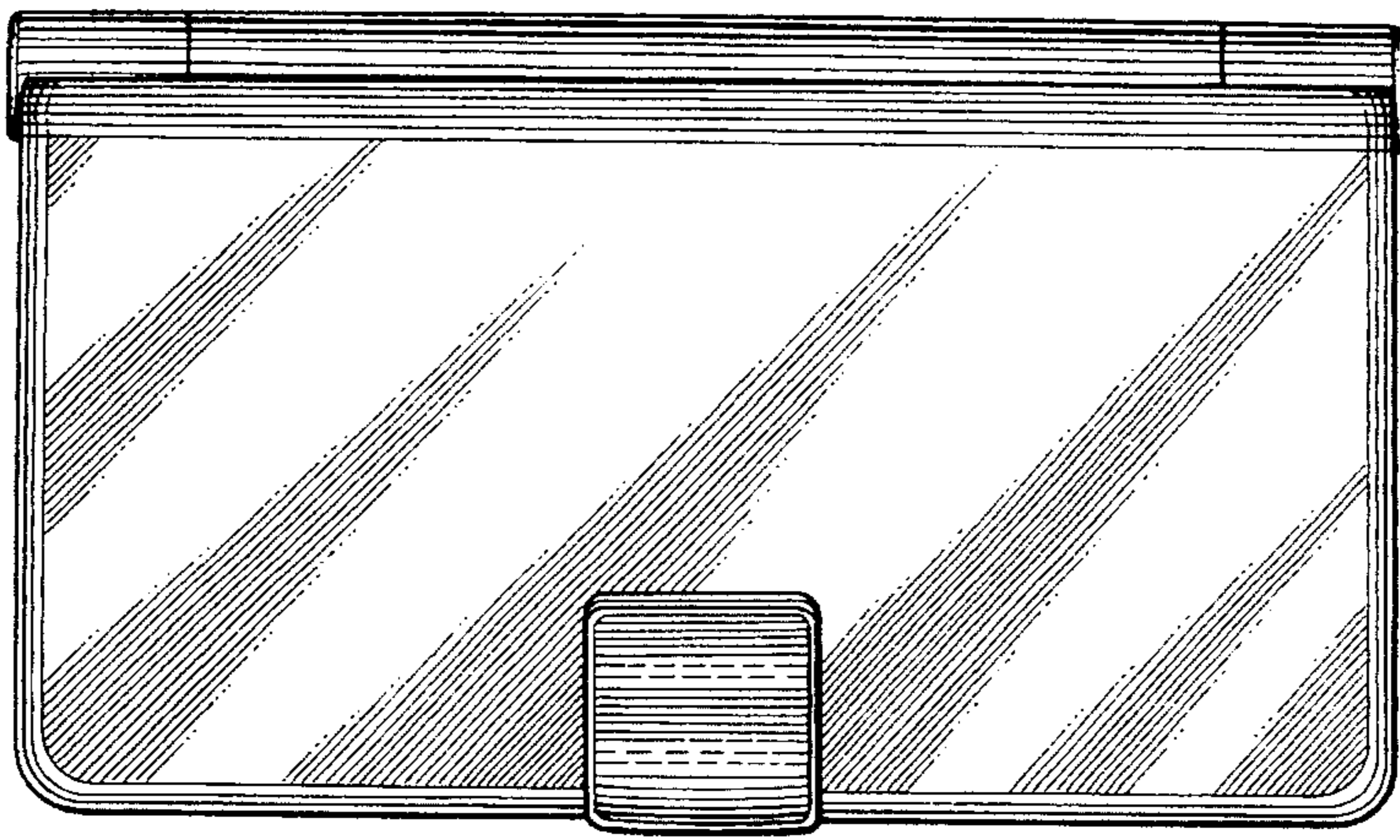

FIG. 2

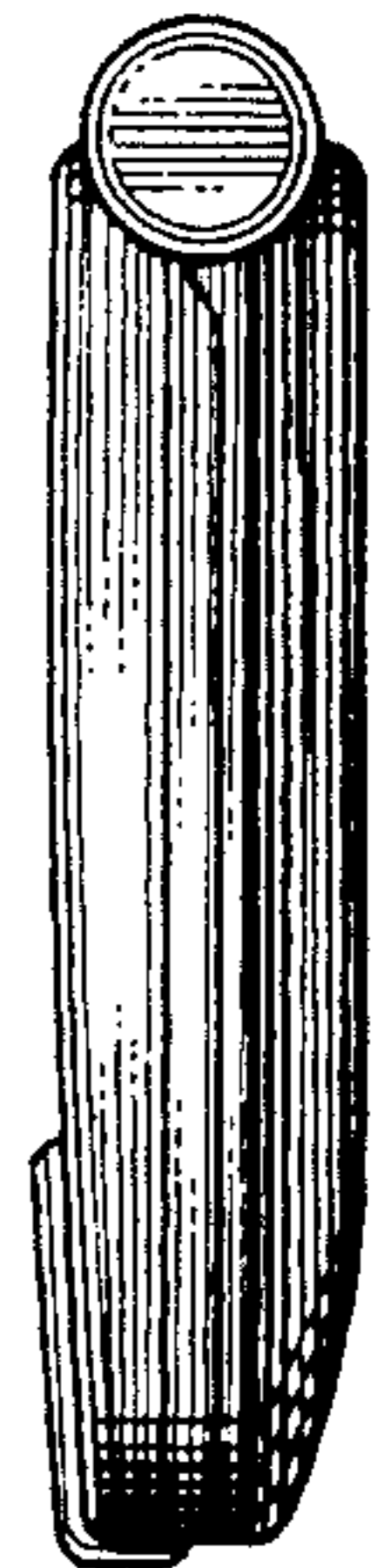

FIG. 5

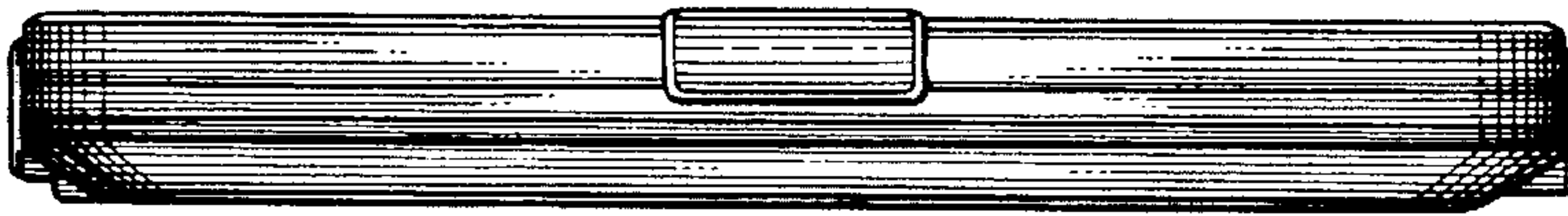

FIG. 6

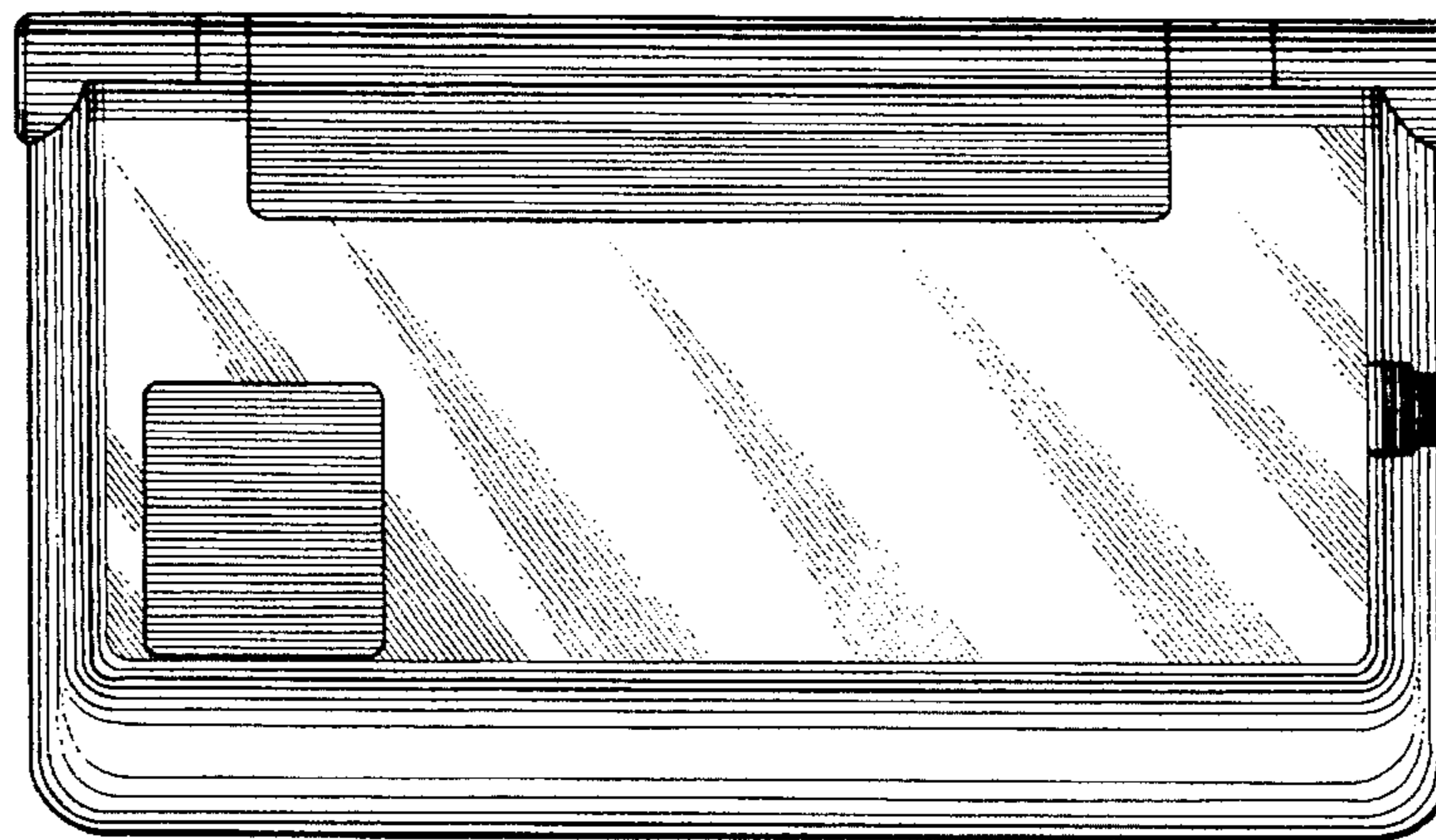
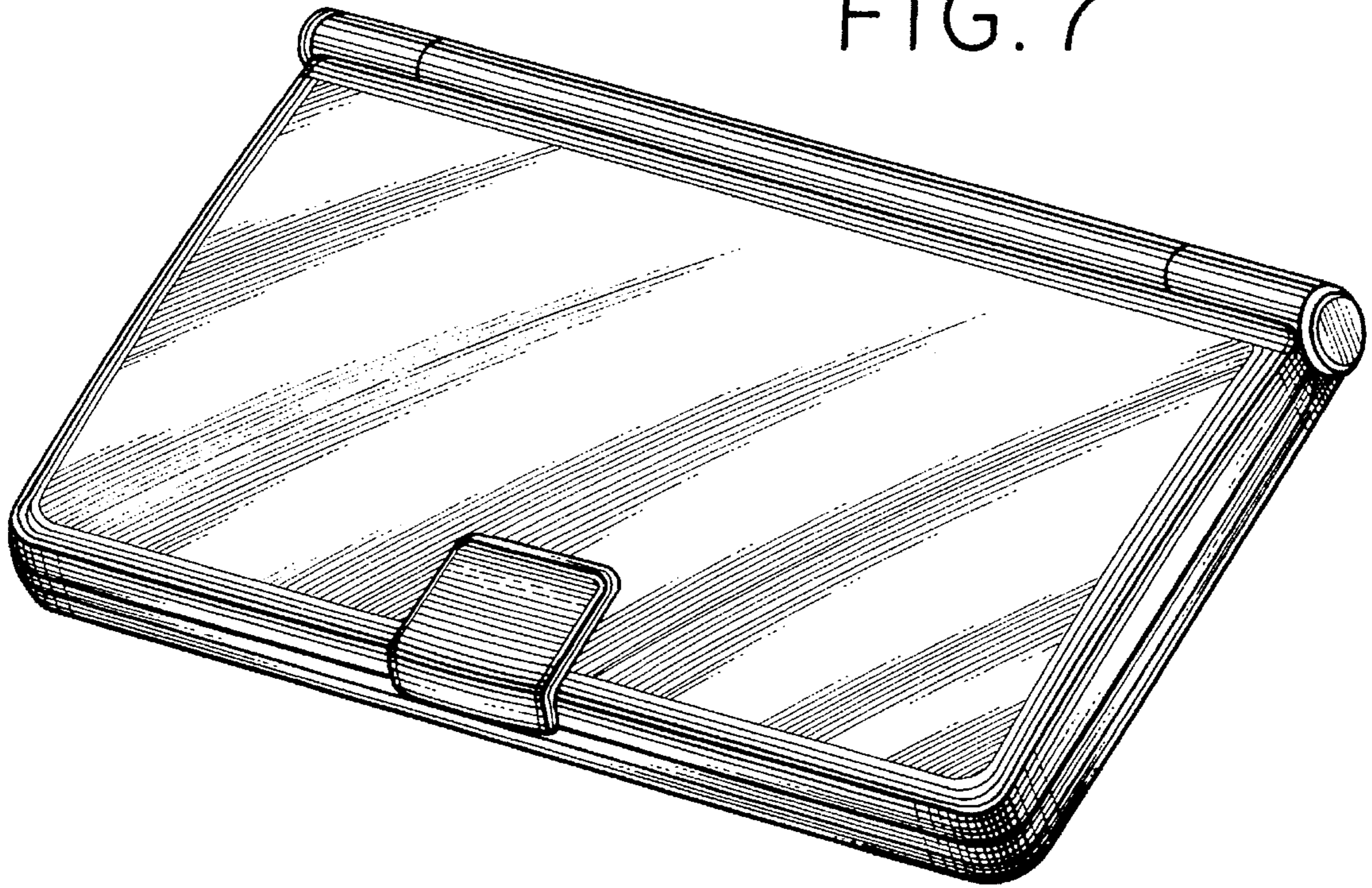

FIG. 7



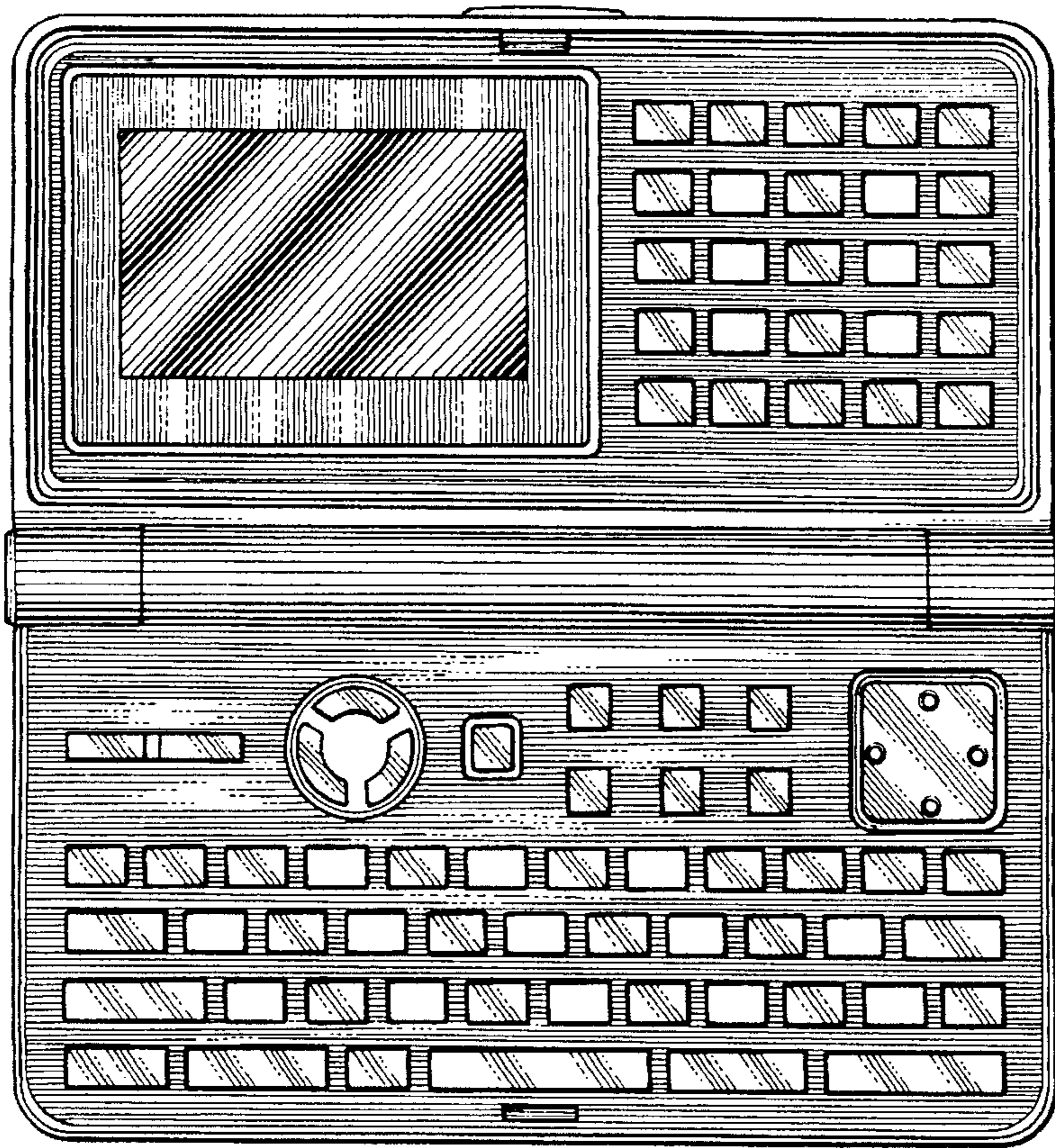

FIG. 8

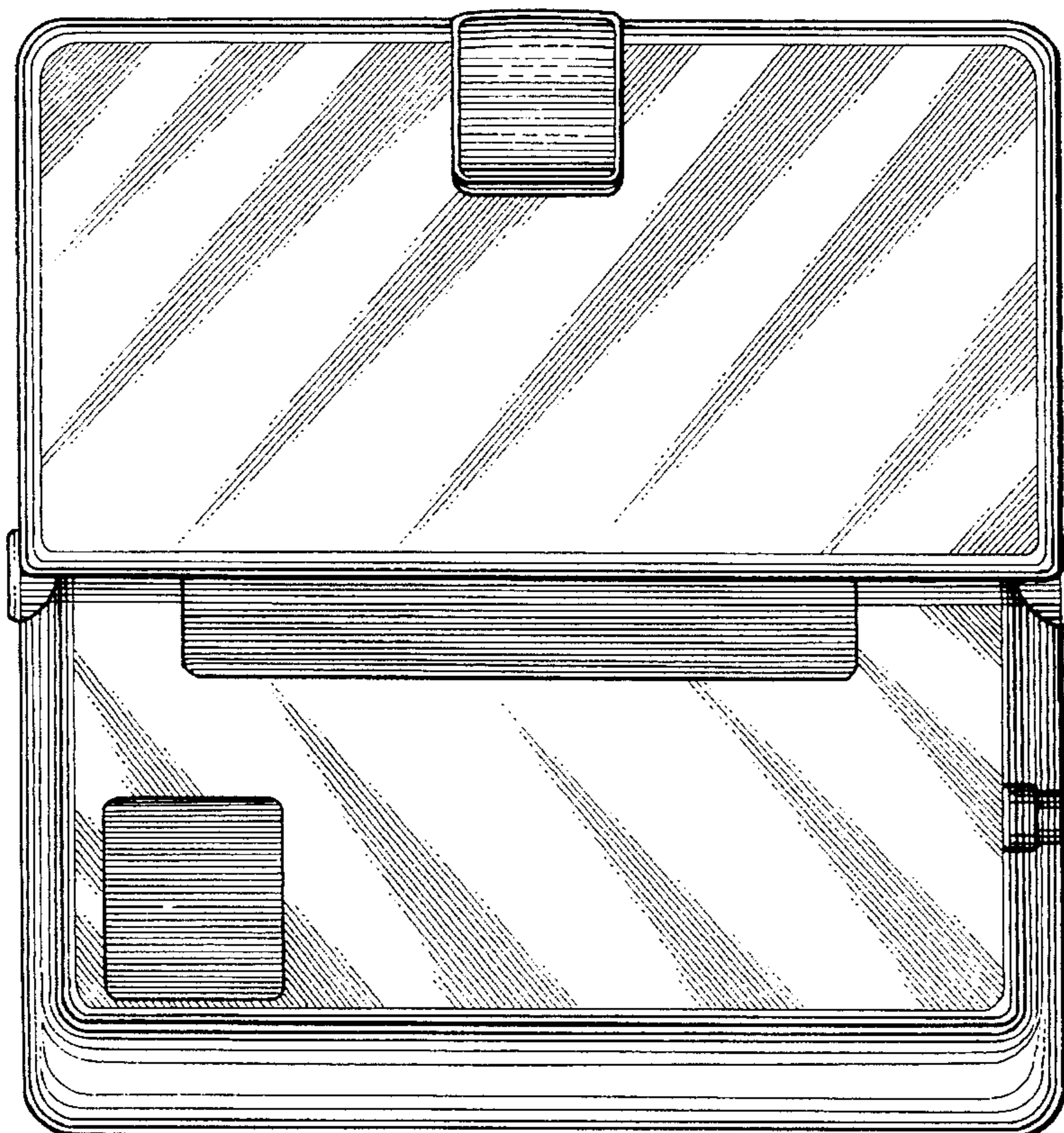

FIG. 9