



US00D377127S

# United States Patent [19]

Barrington

[11] Patent Number: **Des. 377,127**

[45] Date of Patent: **\*\*Jan. 7, 1997**

[54] **COMBINED PLANT TROLLEY AND  
POTTING BENCH**

D. 341,914 11/1993 Reiner ..... D34/19 X  
3,985,372 10/1976 Olsson ..... 280/652

[76] Inventor: **Christopher J. Barrington, 33  
Glebelands Johnston, Haverfordwest,  
Dyfed, S.W. Wales, United Kingdom**

*Primary Examiner*—Louis S. Zarfaz  
*Assistant Examiner*—Monica A. Hannon

[\*\*] Term: **14 Years**

[57] **CLAIM**

The ornamental design for a combined plant trolley and potting bench, as shown and described.

[21] Appl. No.: **15,765**

**DESCRIPTION**

[22] Filed: **Nov. 29, 1993**

[52] U.S. Cl. .... **D6/477; D6/479; D34/21**

[58] Field of Search ..... D6/429, 430, 431,  
D6/477, 478, 479, 481, 486; D34/17, 19,  
20, 21; 108/59; 280/35, 47.1, 651, 652

FIG. 1 is a front elevational view of the combined plant trolley and potting bench showing my new design; FIG. 2 is a rear elevational view thereof; FIG. 3 is a left side elevational view thereof; FIG. 4 is a right side elevational view thereof; FIG. 5 is a top plan view thereof; and, FIG. 6 is a bottom plan view thereof; and, FIG. 7 is an isometric view thereof.

[56] **References Cited**

**U.S. PATENT DOCUMENTS**

D. 301,652 6/1989 Roberts ..... D6/479 X  
D. 340,561 10/1993 Dunn, Jr. .... D34/21

**1 Claim, 4 Drawing Sheets**

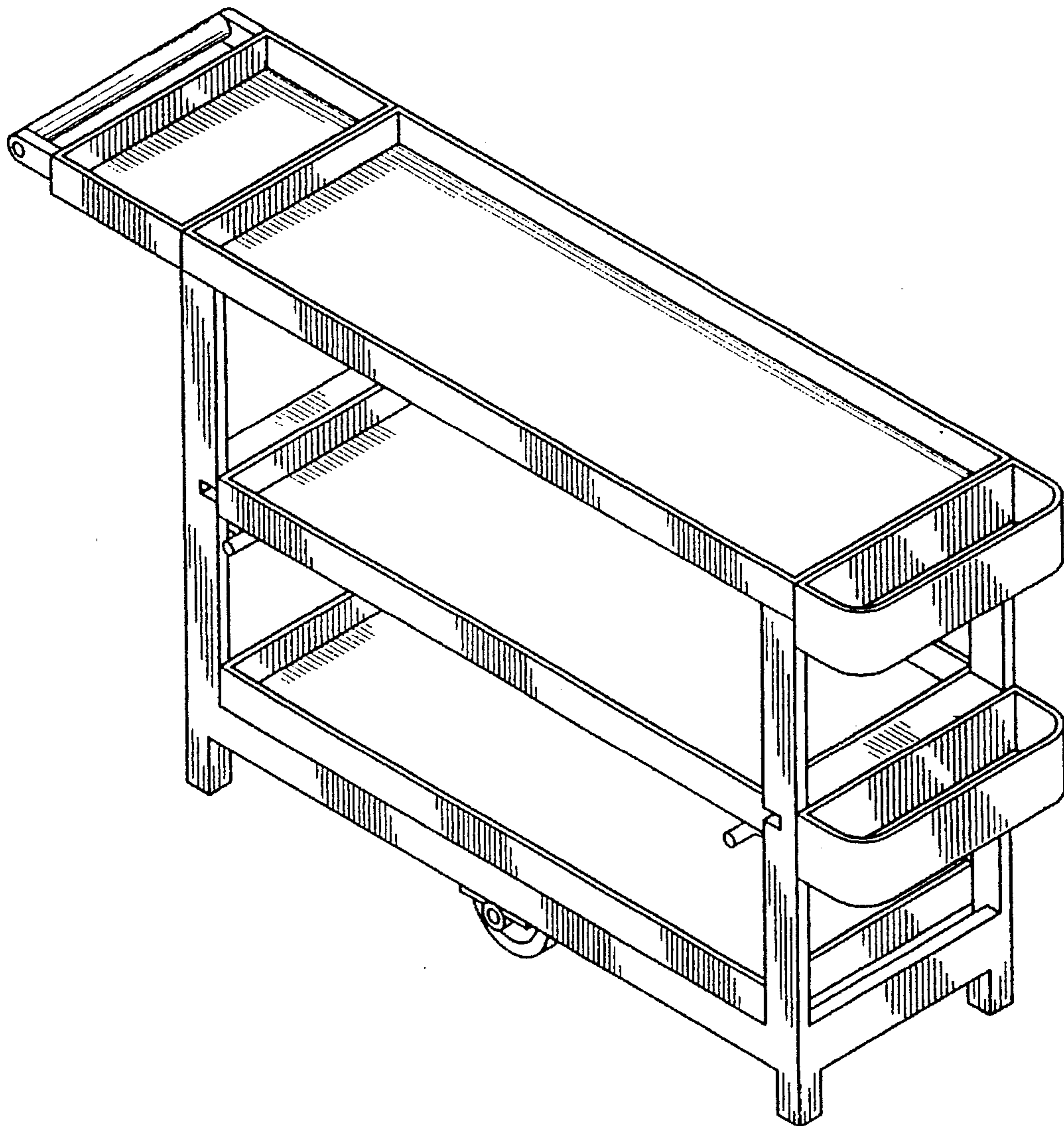

FIG. 1

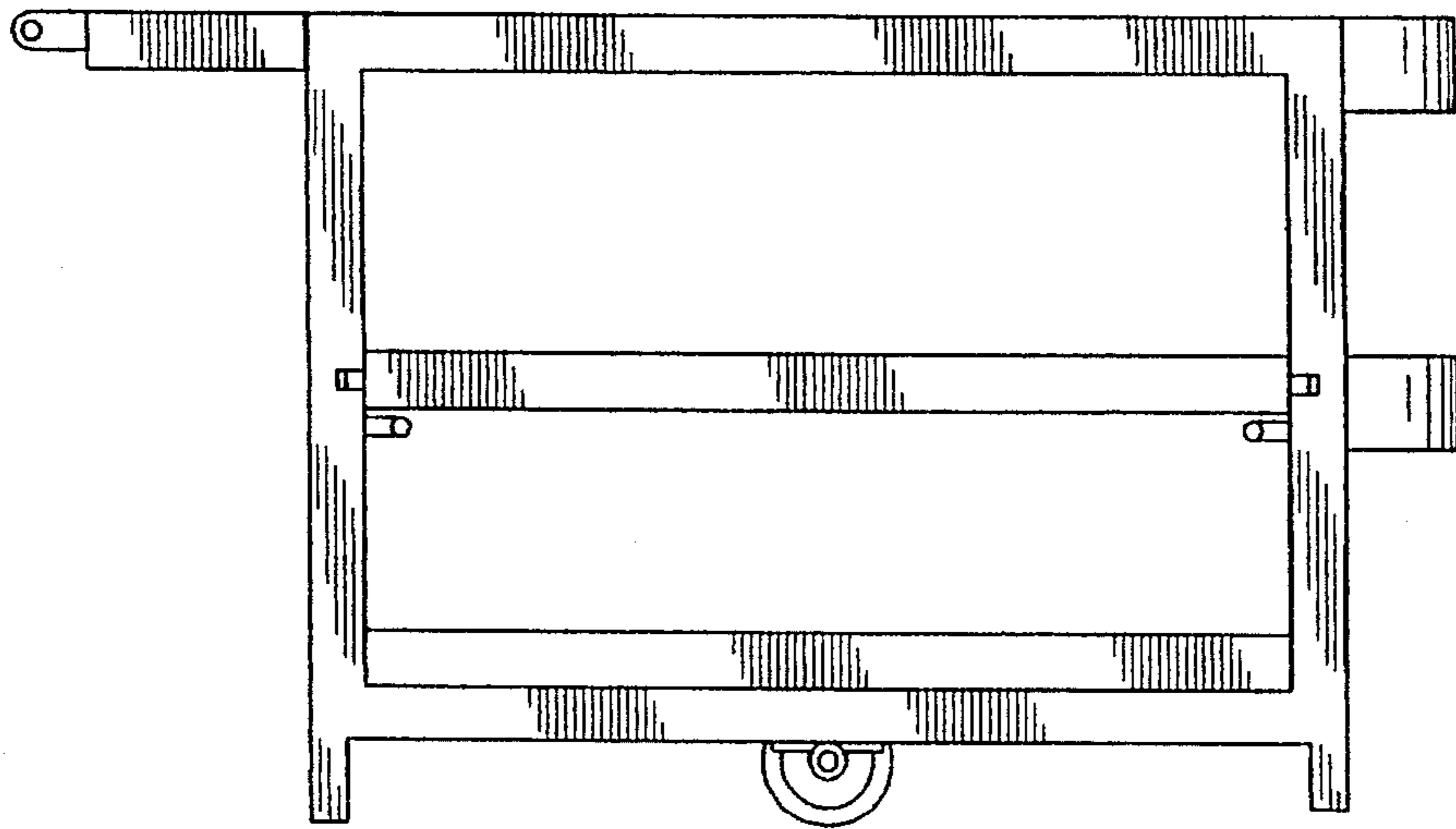

FIG. 2

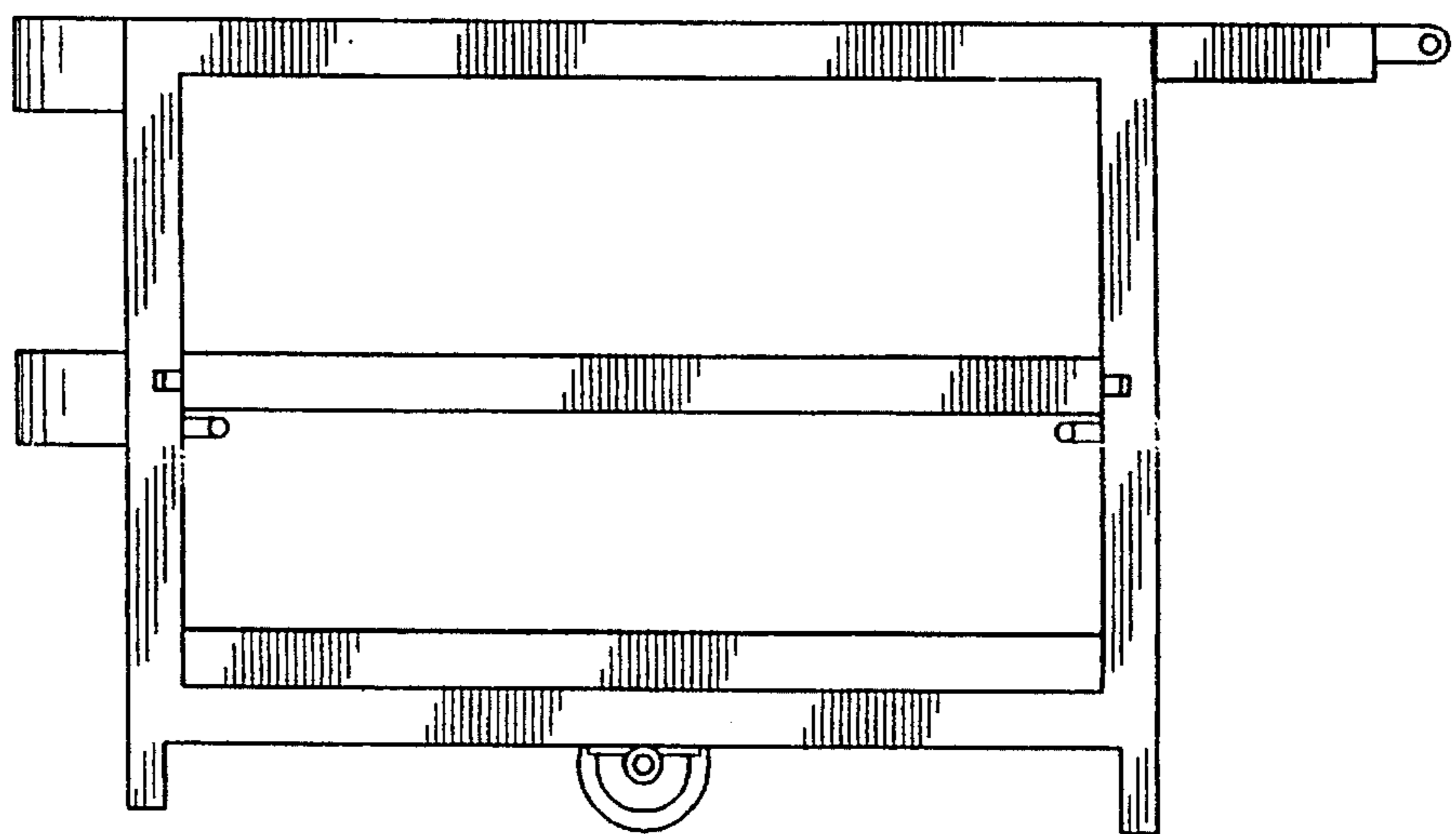

FIG. 3

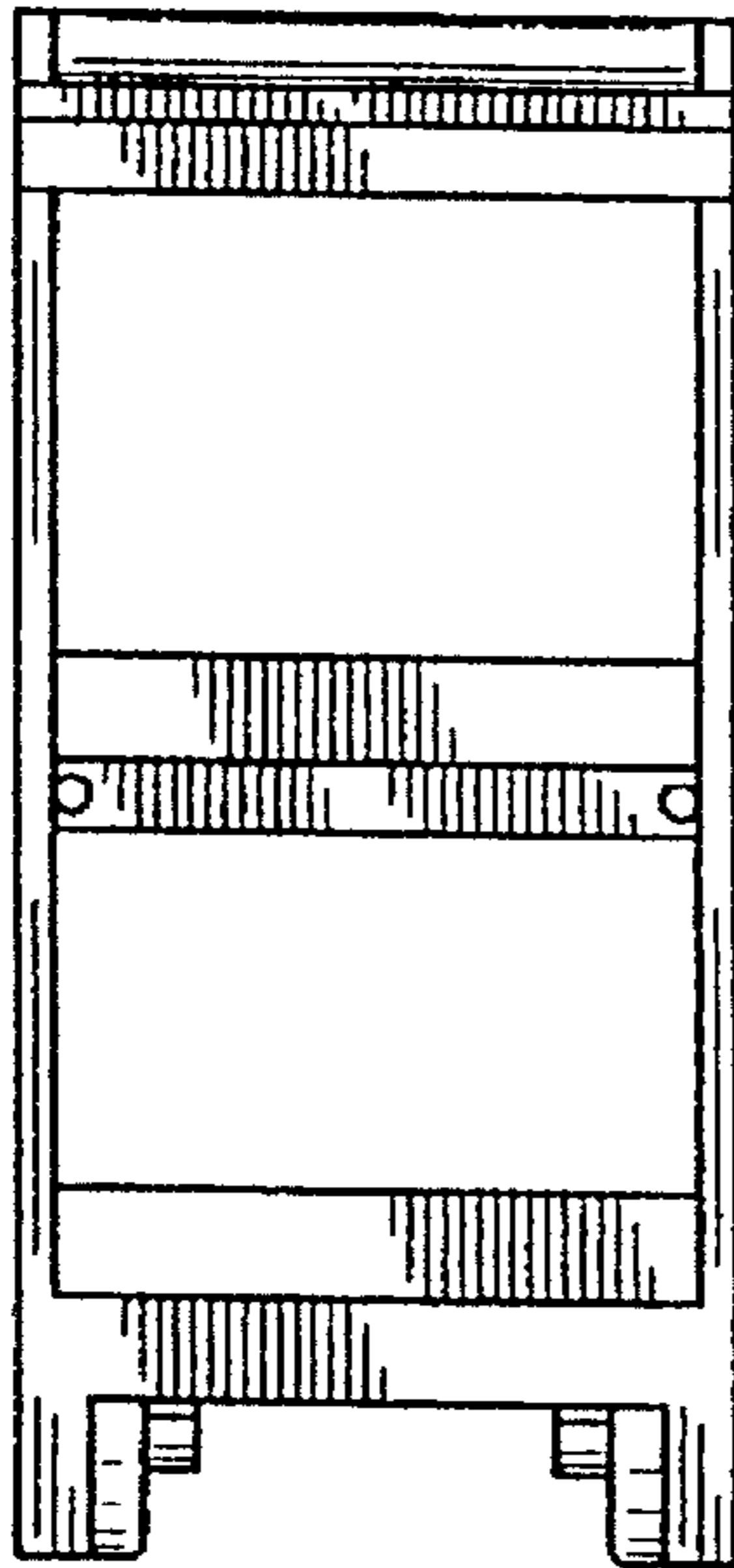
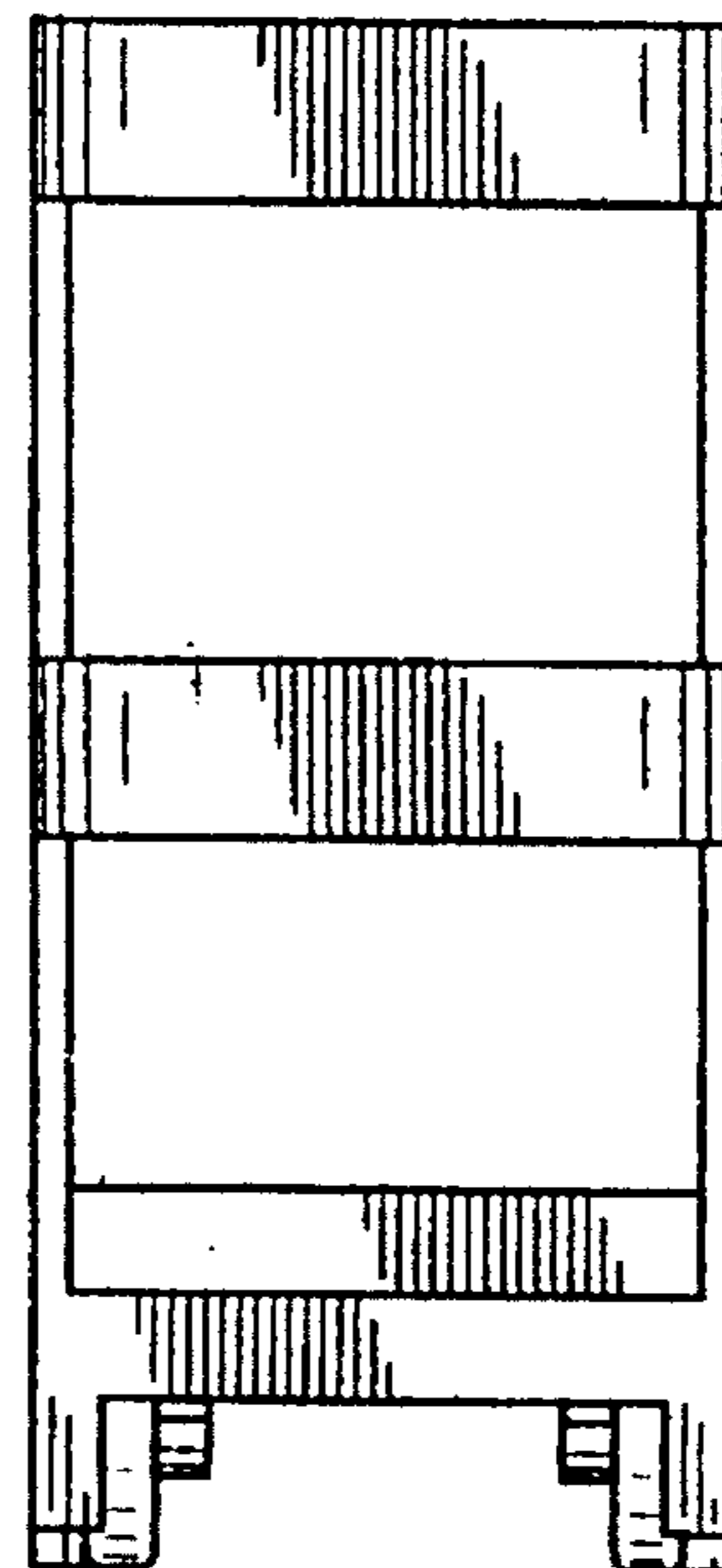
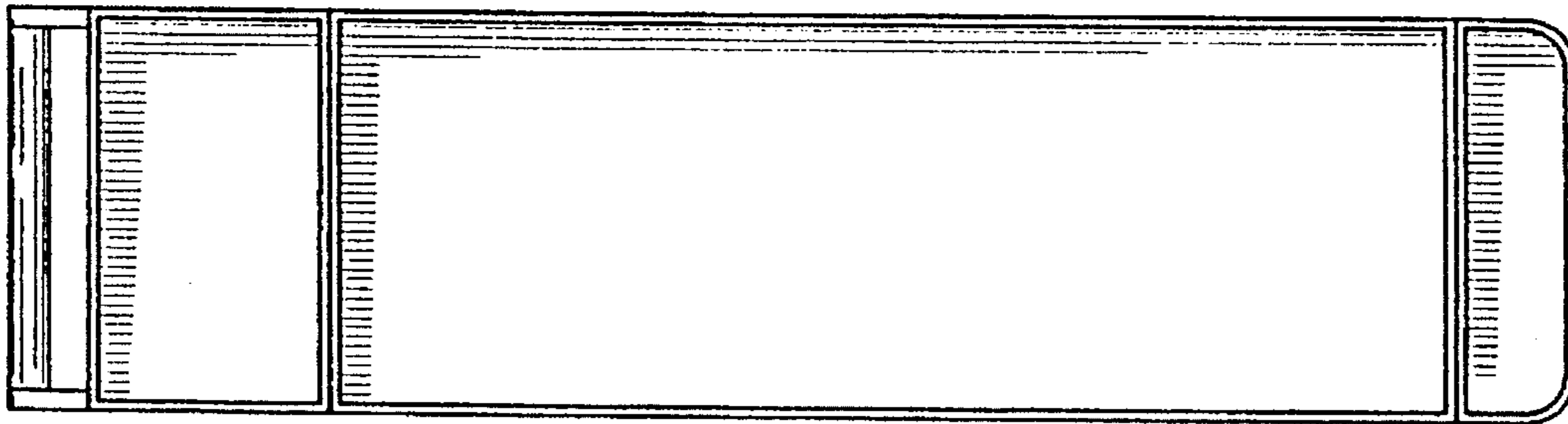

FIG. 4



*FIG. 5*



*FIG. 6*

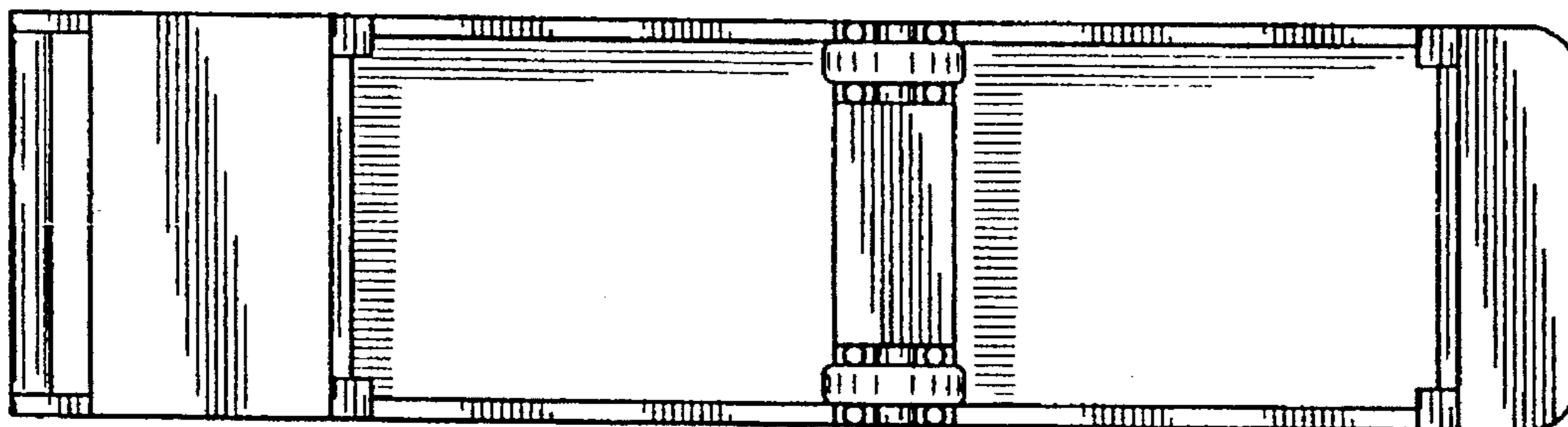

FIG. 7

