



US00D377124S

United States Patent [19]

Stirling et al.

[11] Patent Number: Des. 377,124

[45] Date of Patent: **Jan. 7, 1997

[54] COMBINED BOWLING BALL RACK AND TABLE

[75] Inventors: Michael F. Stirling; Michael J. Katje, both of Spring Lake, Mich.

[73] Assignee: Brunswick Bowling & Billiards Corporation, Muskegon, Mich.

[**] Term: 14 Years

[21] Appl. No.: 33,090

[22] Filed: Jan. 5, 1995

[52] U.S. Cl. D6/397; D6/465; D6/552

[58] Field of Search D25/58; D6/481, D6/552, 479, 411, 414, 397, 629, 462, 465, 474, 584; D21/233; 108/50, 59, 92, 93, 150

[56] References Cited

U.S. PATENT DOCUMENTS

D. 129,594	10/1941	Reiss	D21/233
D. 145,149	7/1946	Welke	D6/474
D. 175,646	9/1955	Reinman	D21/233
D. 189,536	1/1961	Dreyfuss	D21/233
D. 191,790	11/1961	Schaefer	34/5
D. 193,791	10/1962	Konves	34/5
D. 212,482	10/1968	Lum et al.	D6/465
D. 276,388	11/1984	Miller et al.	D6/548
D. 286,353	10/1986	Robolin	D6/479
D. 308,309	6/1990	Gersin et al.	D6/465
D. 313,715	1/1991	Ohno	6/552
D. 314,110	1/1991	Ohno	6/552
D. 314,111	1/1991	Ohno	6/552
1,802,047	4/1931	Brown	108/150
1,863,597	6/1932	Handelan	108/92
2,540,353	2/1951	Schick	108/92
2,719,771	10/1955	Hoven et al.	108/150
2,748,954	6/1956	Murren	D6/479
2,862,469	3/1958	Grant	108/50
3,179,071	4/1965	Johnston	108/50
4,827,850	5/1989	Diffrient	108/50

FOREIGN PATENT DOCUMENTS

2040065	7/1975	Germany	108/150
2257897	1/1993	United Kingdom	108/92

Primary Examiner—Louis S. Zarfes
Assistant Examiner—Gregory Andoll
Attorney, Agent, or Firm—Price, Heneveld, Cooper, DeWitt & Litton

[57] CLAIM

The ornamental design for the combined bowling ball rack and table, as shown and described.

DESCRIPTION

FIG. 1 is a front perspective view of the first embodiment of a combined bowling ball rack and table showing our new design;

FIG. 2 is a top plan view of this first embodiment;

FIG. 3 is a front elevational view of this first embodiment;

FIG. 4 is a rear elevational view of this first embodiment;

FIG. 5 is a right end elevational view of this first embodiment;

The left end elevational view of this first embodiment is a mirror image of FIG. 5.

FIG. 6 is a front perspective view of a second embodiment of a combined bowling ball rack and table showing our new design;

FIG. 7 is a top plan view of the second embodiment;

FIG. 8 is a front elevational view of the second embodiment;

FIG. 9 is a rear elevational view of the second embodiment; and,

FIG. 10 is a right end elevational view of the second embodiment.

The left end elevational view of the second embodiment is a mirror image of FIG. 10.

The bottom of the combined bowling ball rack and table is plain and unornamented and forms no part of the claimed design.

1 Claim, 6 Drawing Sheets

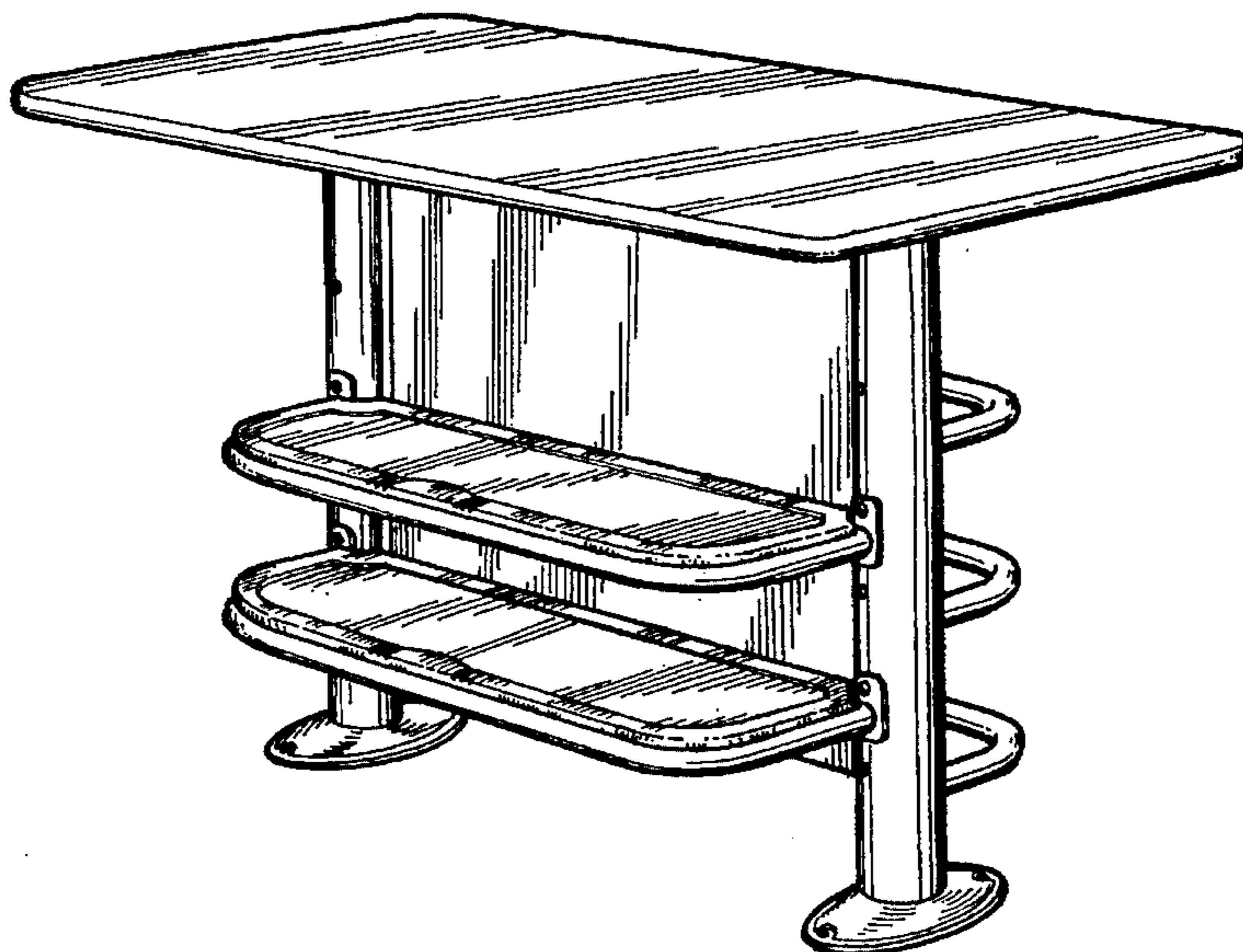

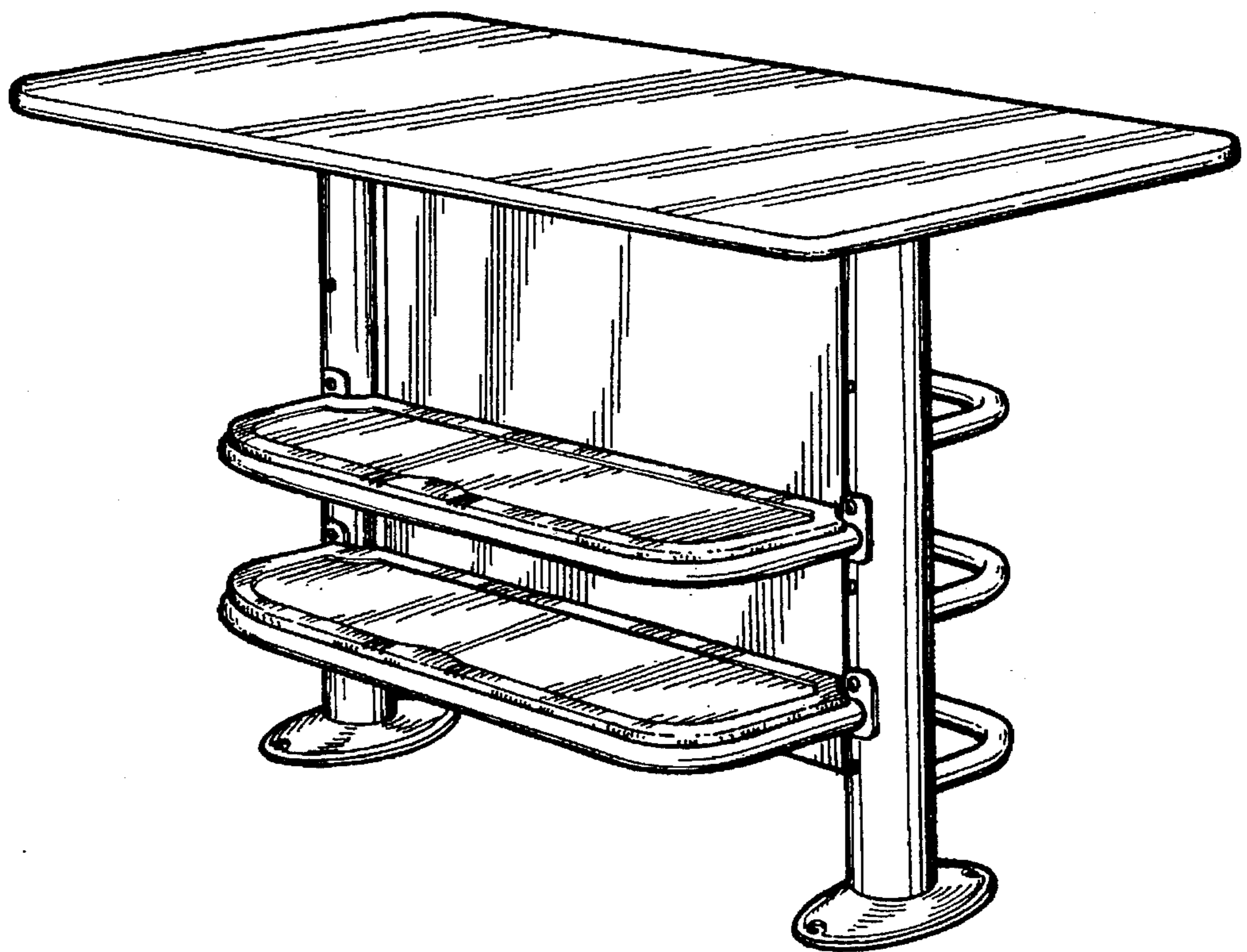

Fig. 1

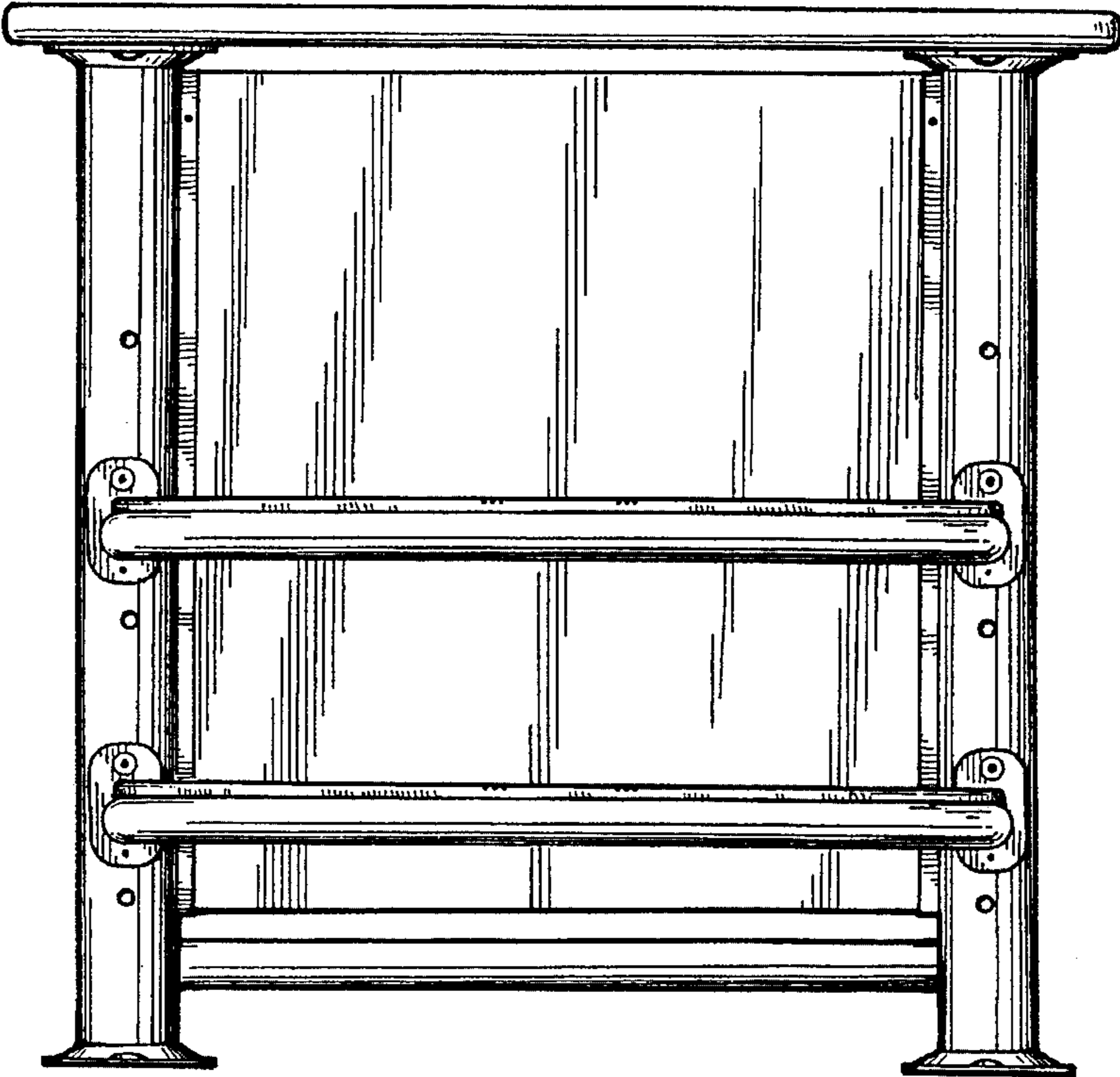

Fig. 3

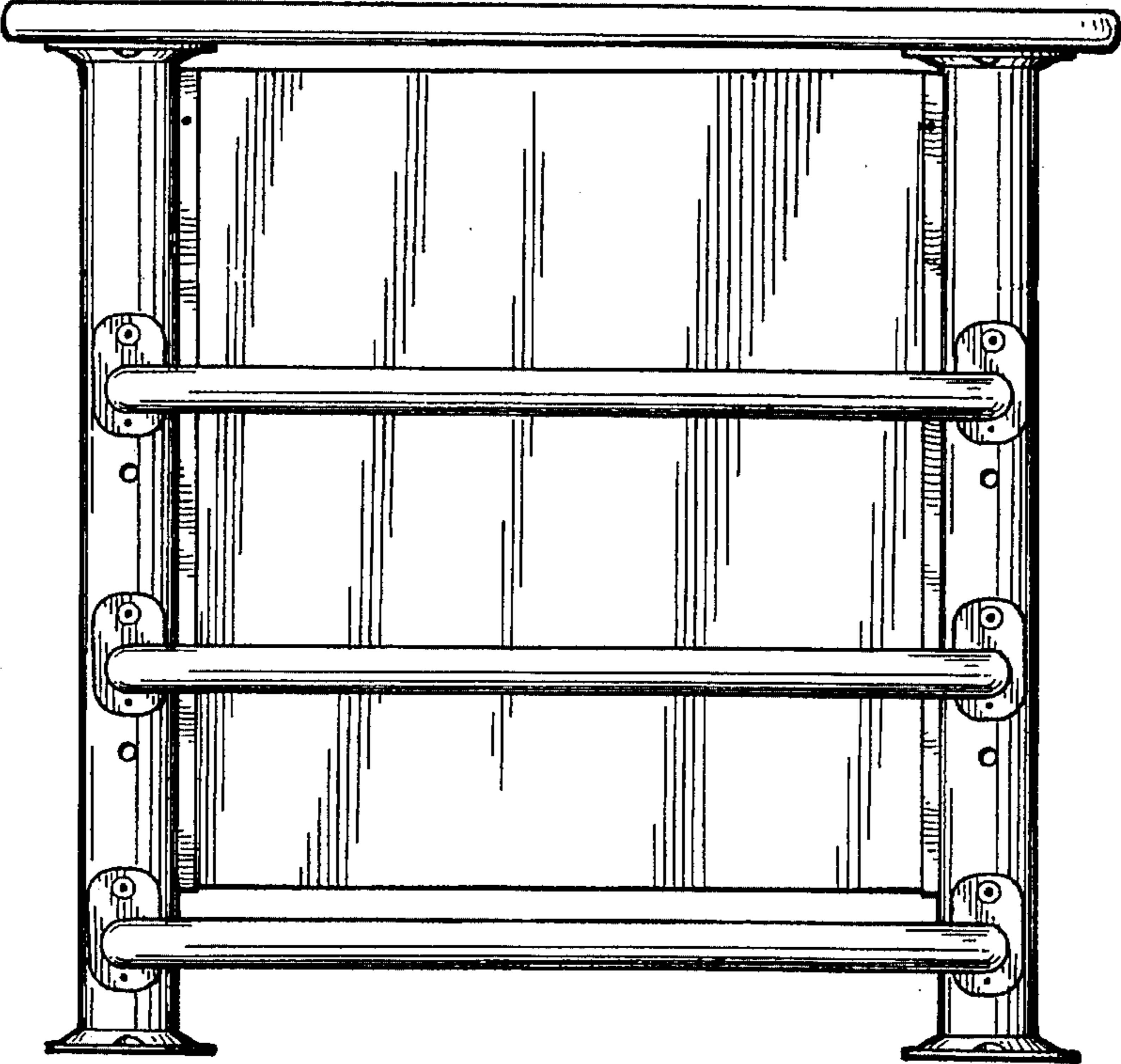

Fig. 4

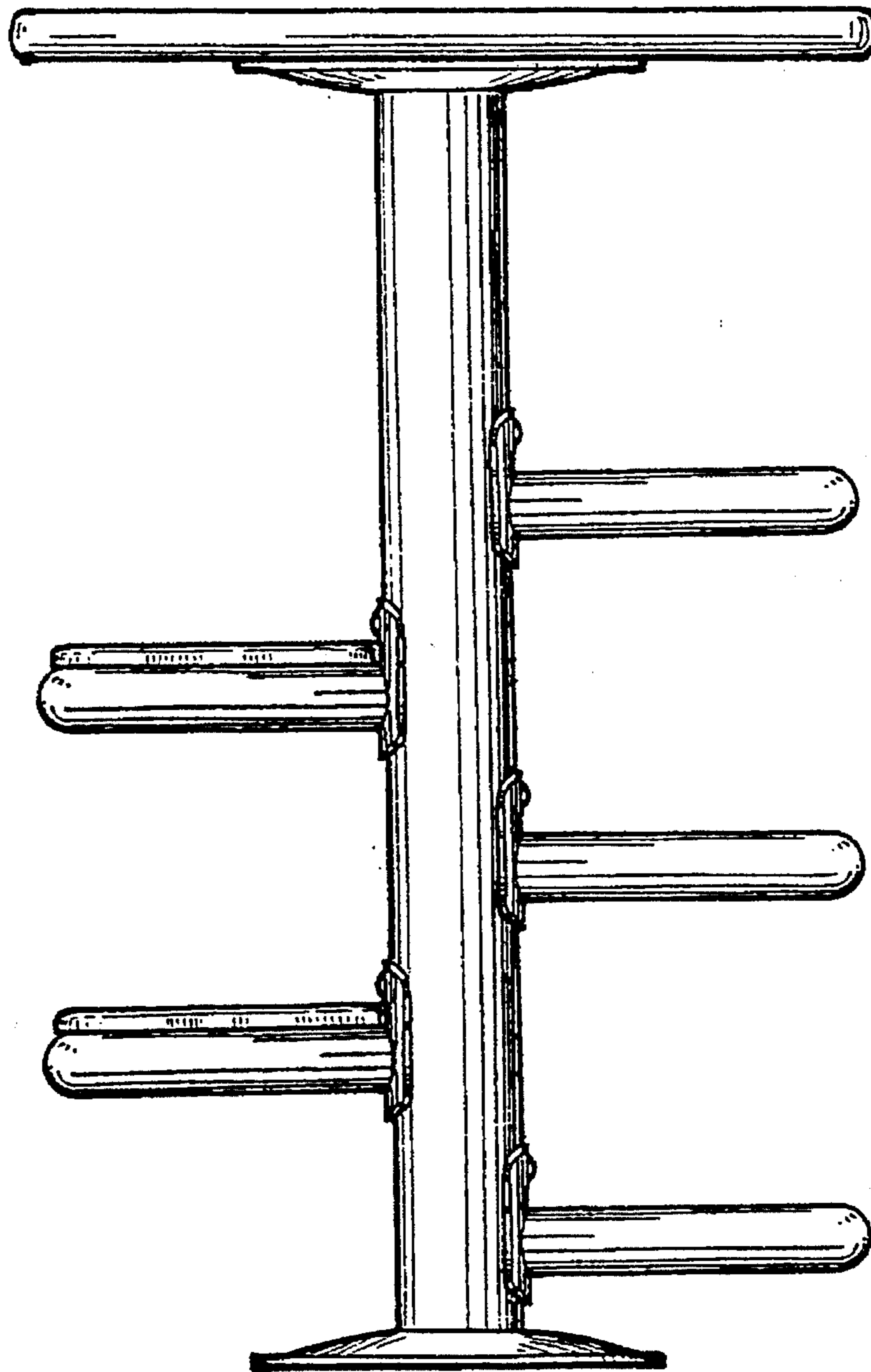

Fig. 5.

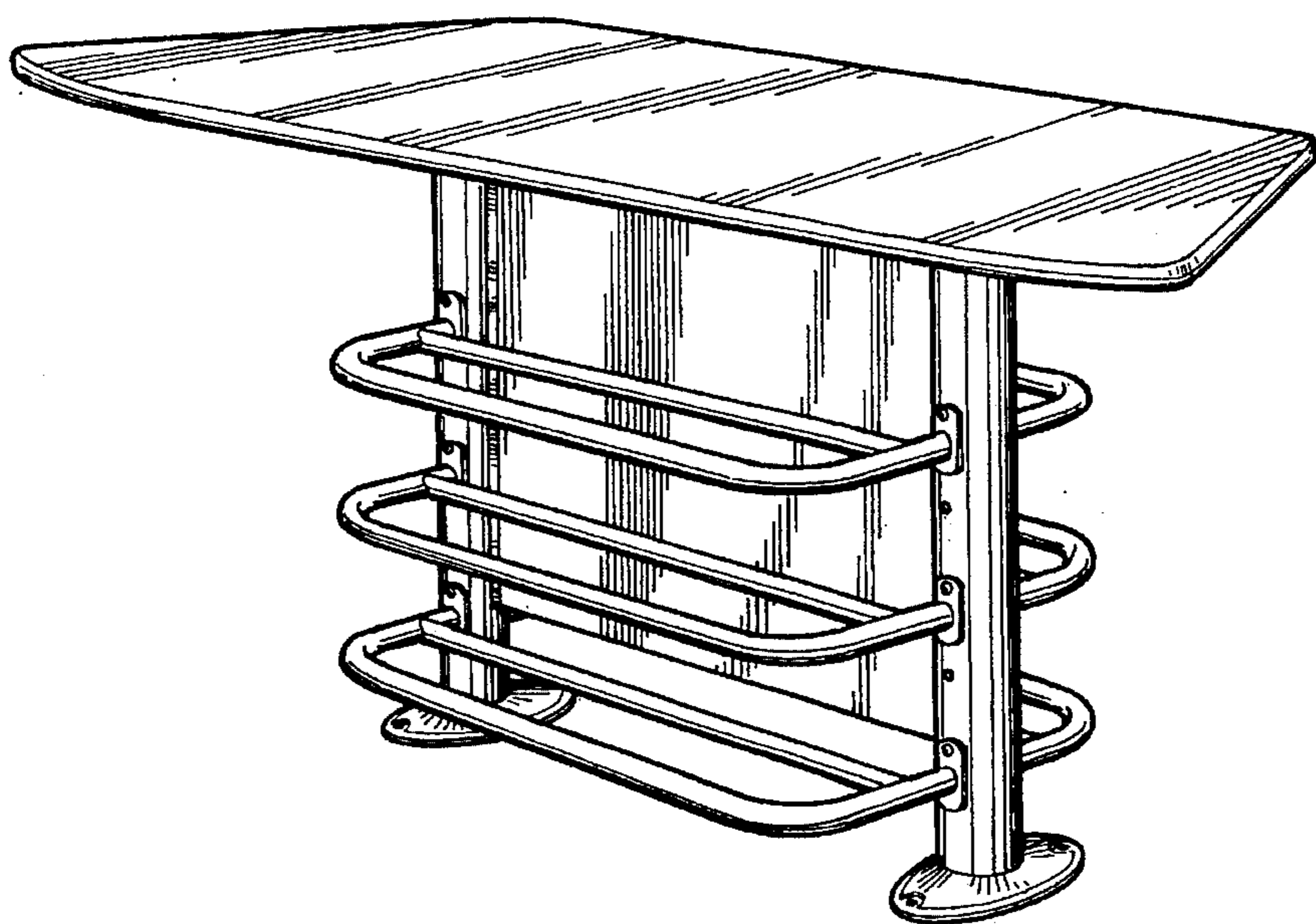

Fig. 6

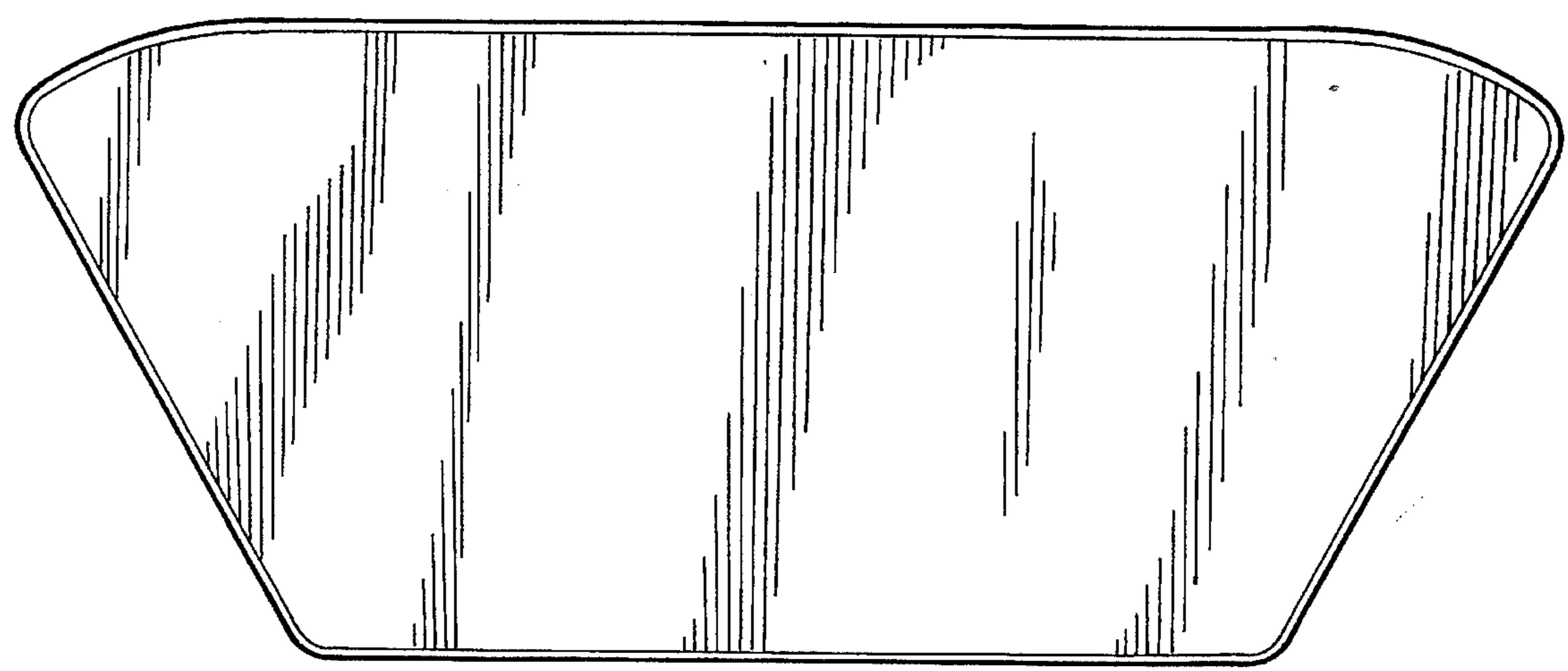

Fig. 7

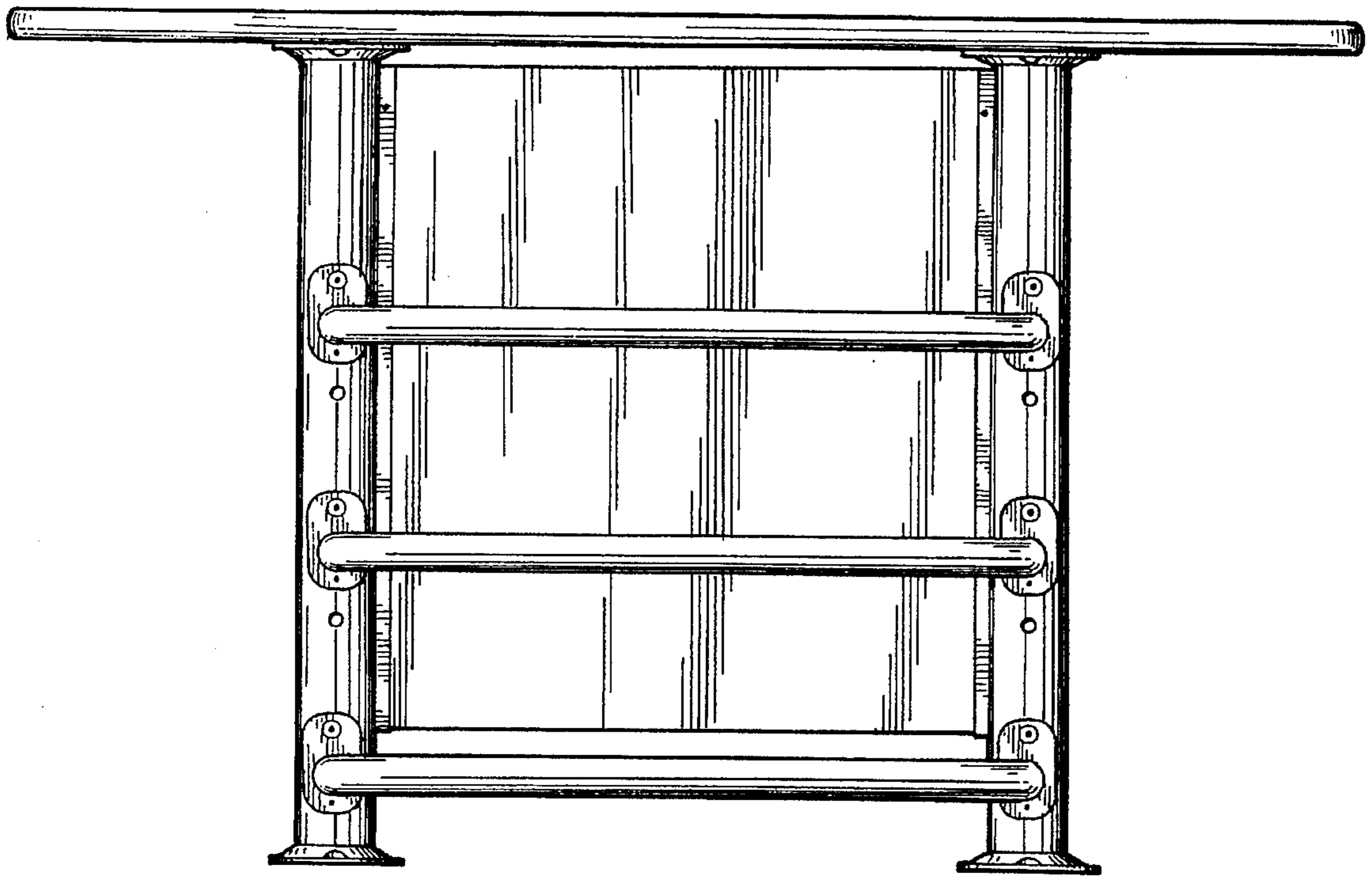

Fig. 8

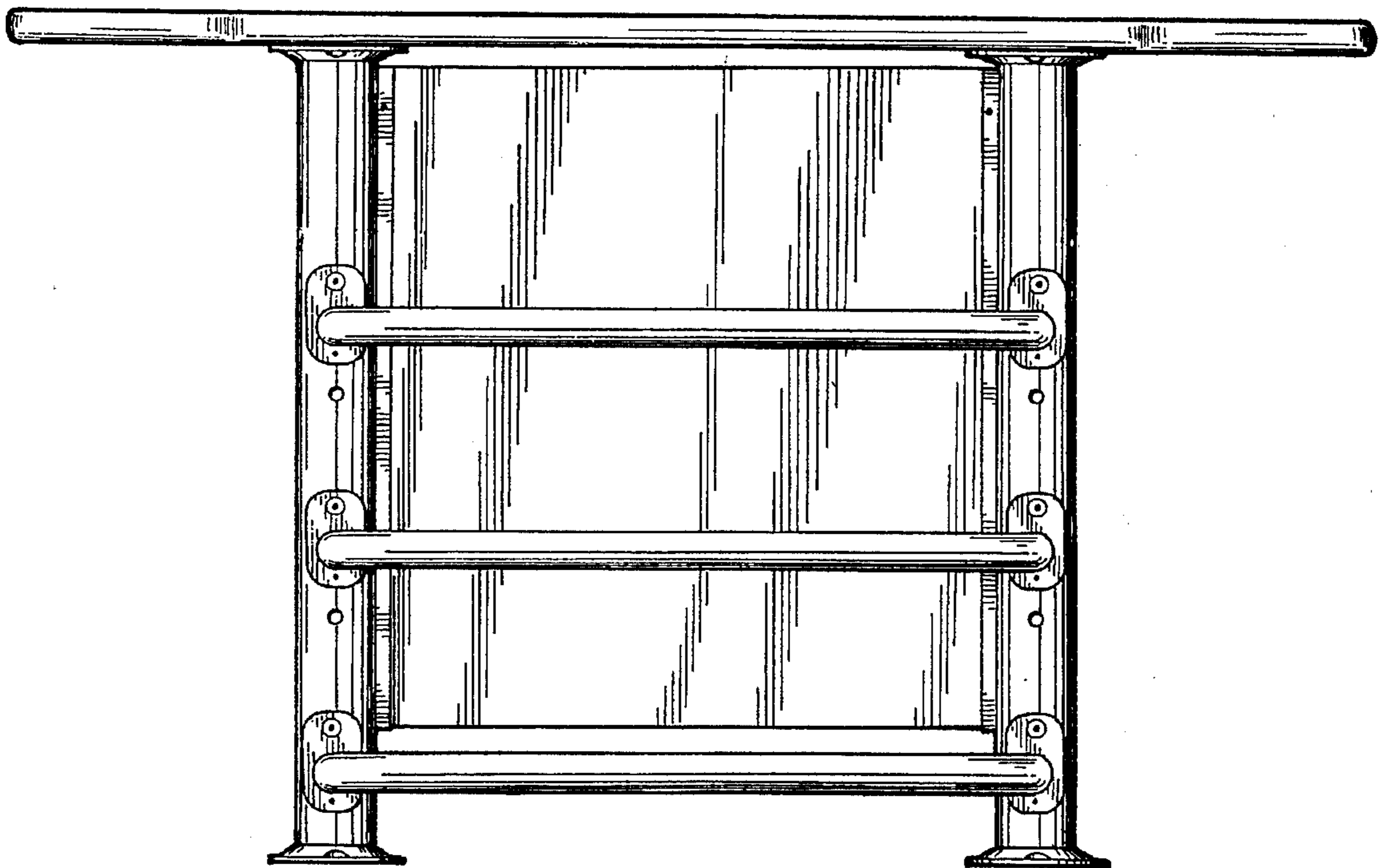

Fig. 9

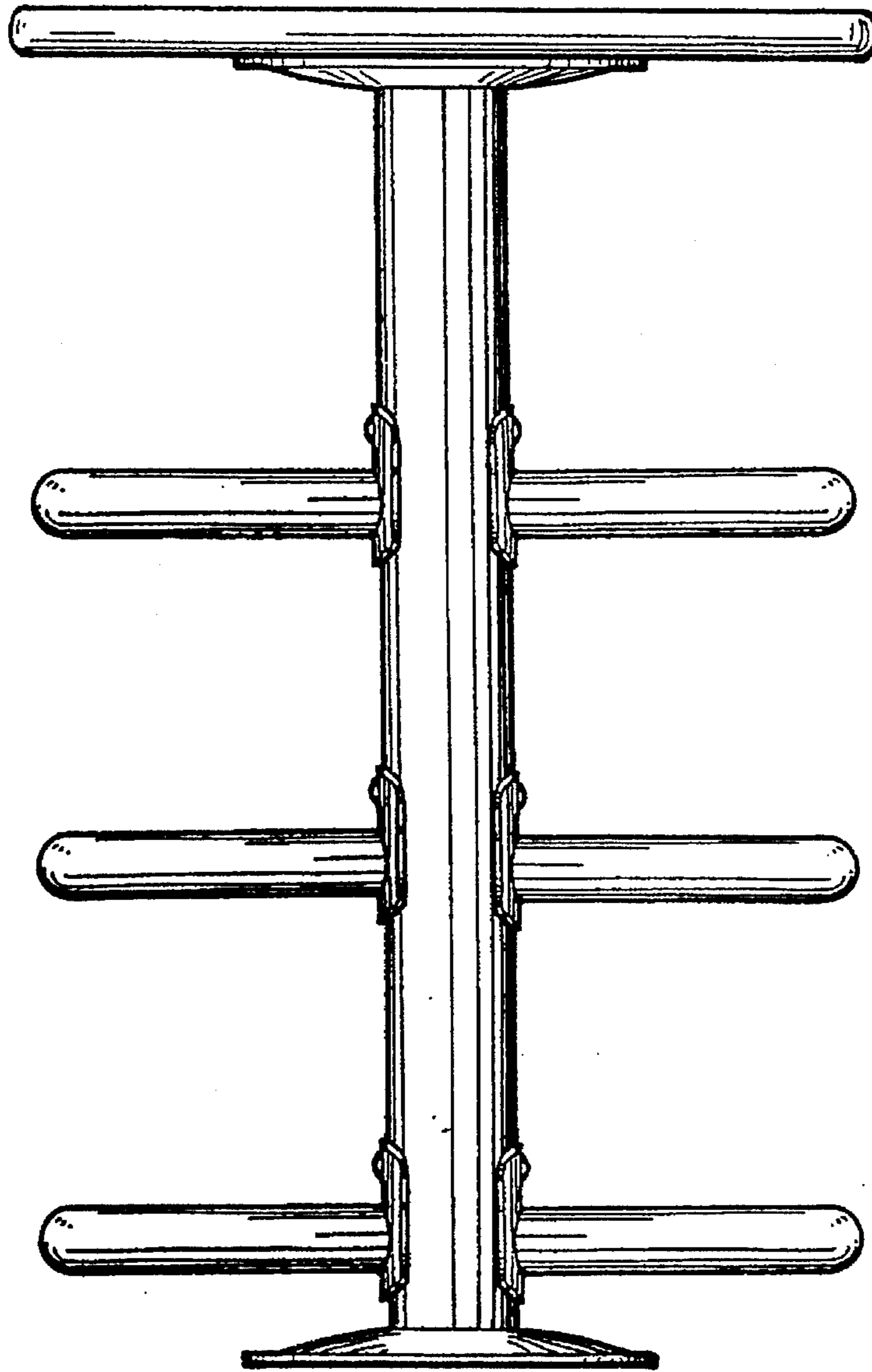

Fig. 10