



US00D377020S

United States Patent [19]

Bungardt et al.

[11] Patent Number: **Des. 377,020**

[45] Date of Patent: ****Dec. 31, 1996**

[54] COMMUNICATIONS HEADSET

[75] Inventors: **Gabriele Bungardt**, Aptos, Calif.; **Luis Pedraza**, West Roxbury, Mass.; **Tim Dearborn**, Rochester Hills, Mich.

[73] Assignee: **Plantronics, Inc.**, Santa Cruz, Calif.

[**] Term: **14 Years**

[21] Appl. No.: **37,706**

[22] Filed: **Apr. 19, 1995**

[52] U.S. Cl. **D14/205; D14/206**

[58] Field of Search D14/137-138,
D14/147, 205-206, 223-224, 249; 181/129-130;
379/430-431, 444; 381/25, 68, 68.6, 69,
151, 183, 187

[56] References Cited

U.S. PATENT DOCUMENTS

D. 337,116 7/1993 Hattori D14/206
D. 364,617 11/1995 Fitzgerald D14/206 X

FOREIGN PATENT DOCUMENTS

404170198 6/1992 Japan 181/137

OTHER PUBLICATIONS

Hello Direct, Catalog of Telephone Productivity Tools, Winter-1991, p. 11, UργοSet Headset. (top right side corner).

Primary Examiner—Sandra L. Morris
Assistant Examiner—Nanda Bondade
Attorney, Agent, or Firm—Fenwick & West LLP

[57] CLAIM

The ornamental design for a communications headset, as shown and described.

DESCRIPTION

FIG. 1 is a front, top, left perspective view of a communications headset showing our new design;
FIG. 2 is a front elevational view taken of FIG. 1;
FIG. 3 is a back elevational view thereof;
FIG. 4 is a right elevational view thereof;
FIG. 5 is a left elevational view thereof;
FIG. 6 is a top plan thereof; and,
FIG. 7 is a bottom plan thereof.

1 Claim, 5 Drawing Sheets

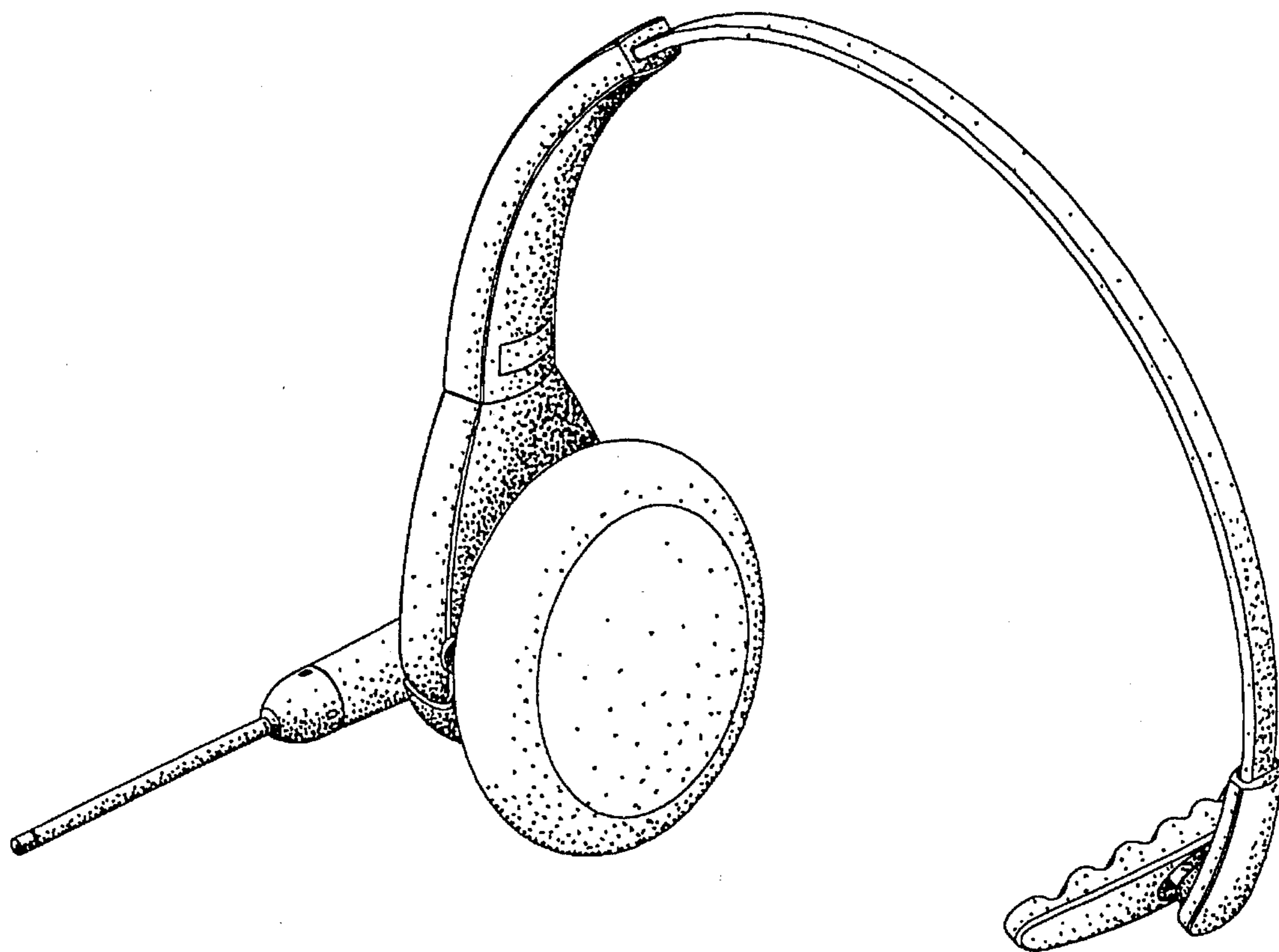

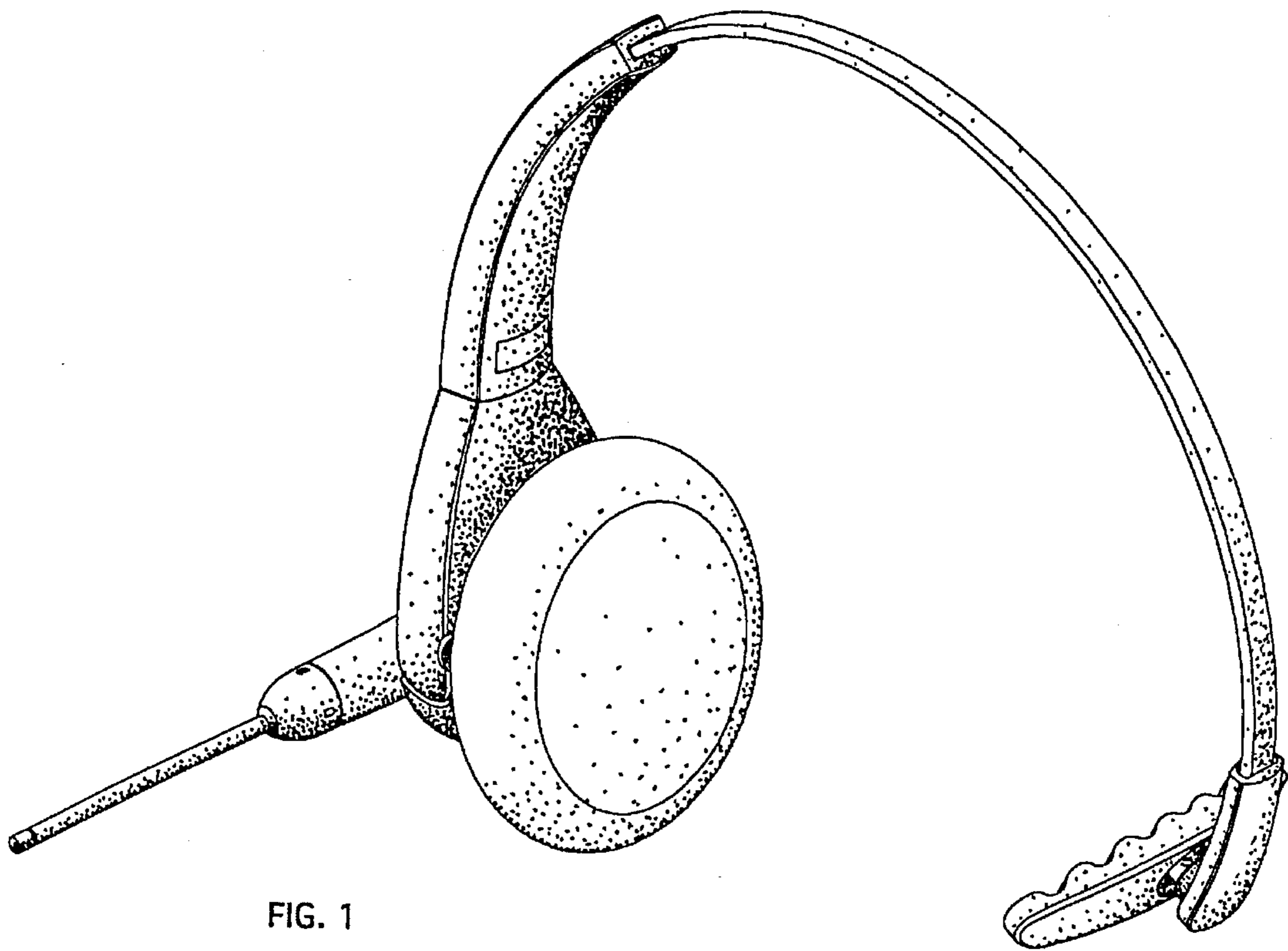

FIG. 1

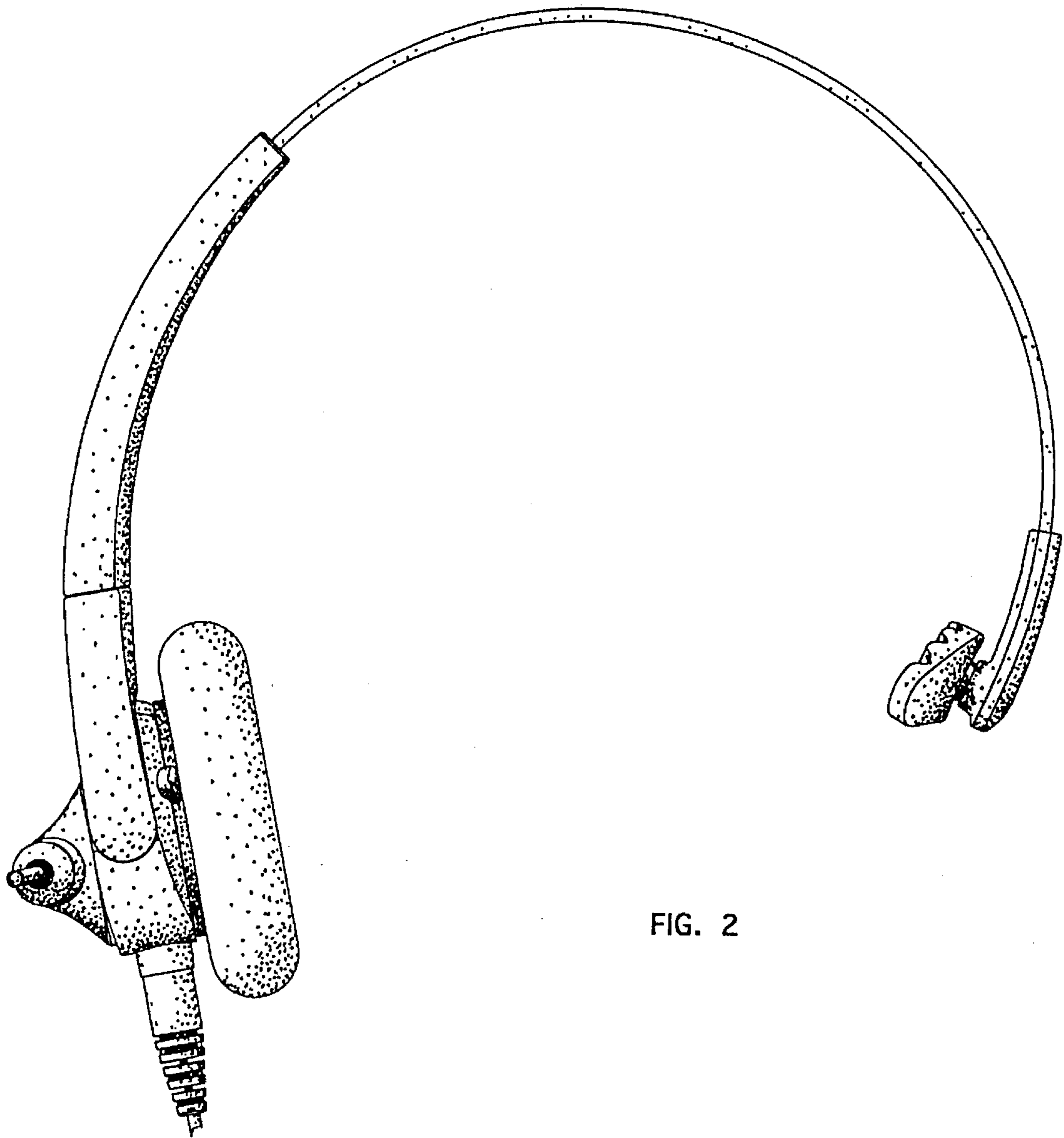

FIG. 2

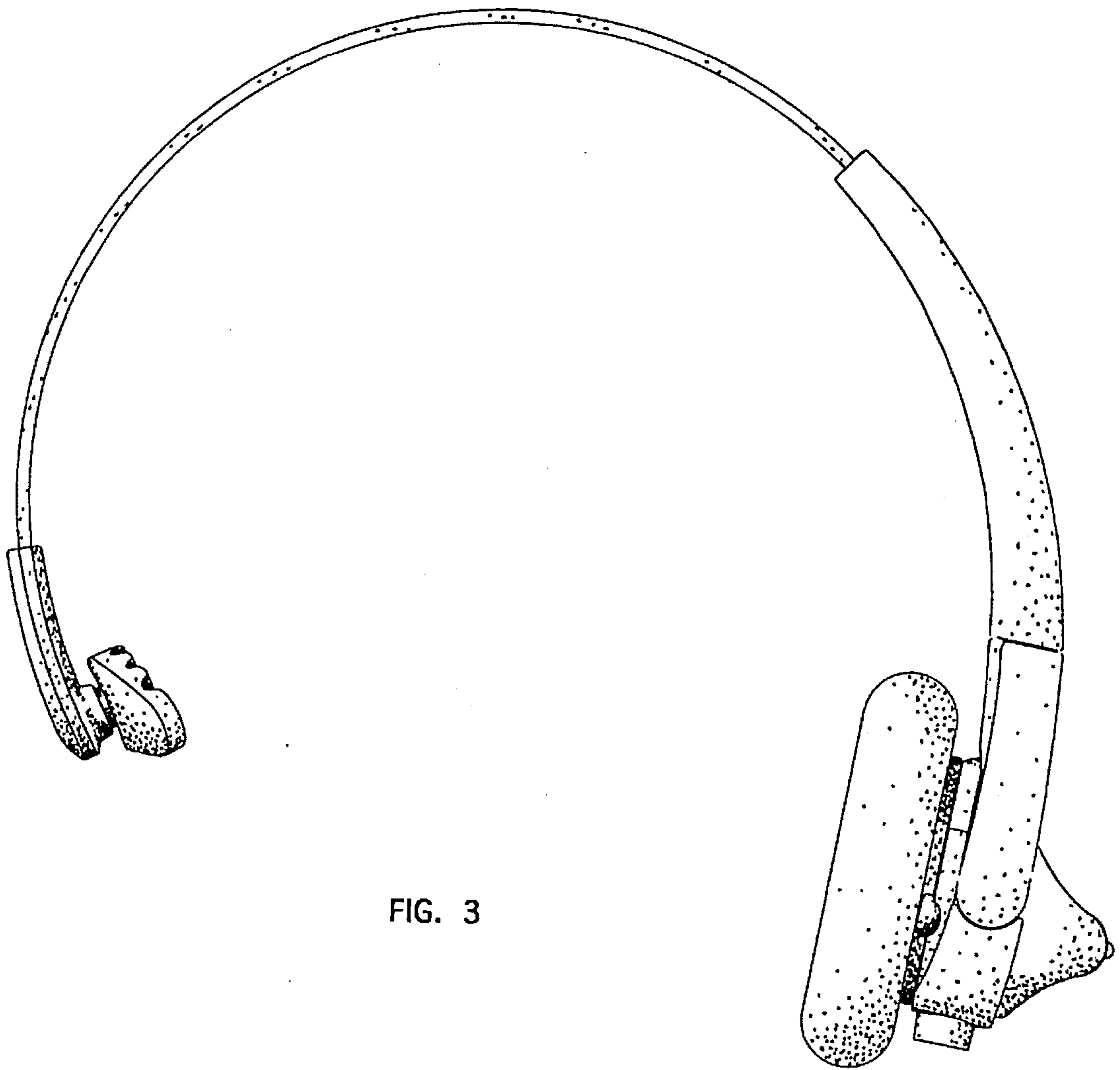

FIG. 3

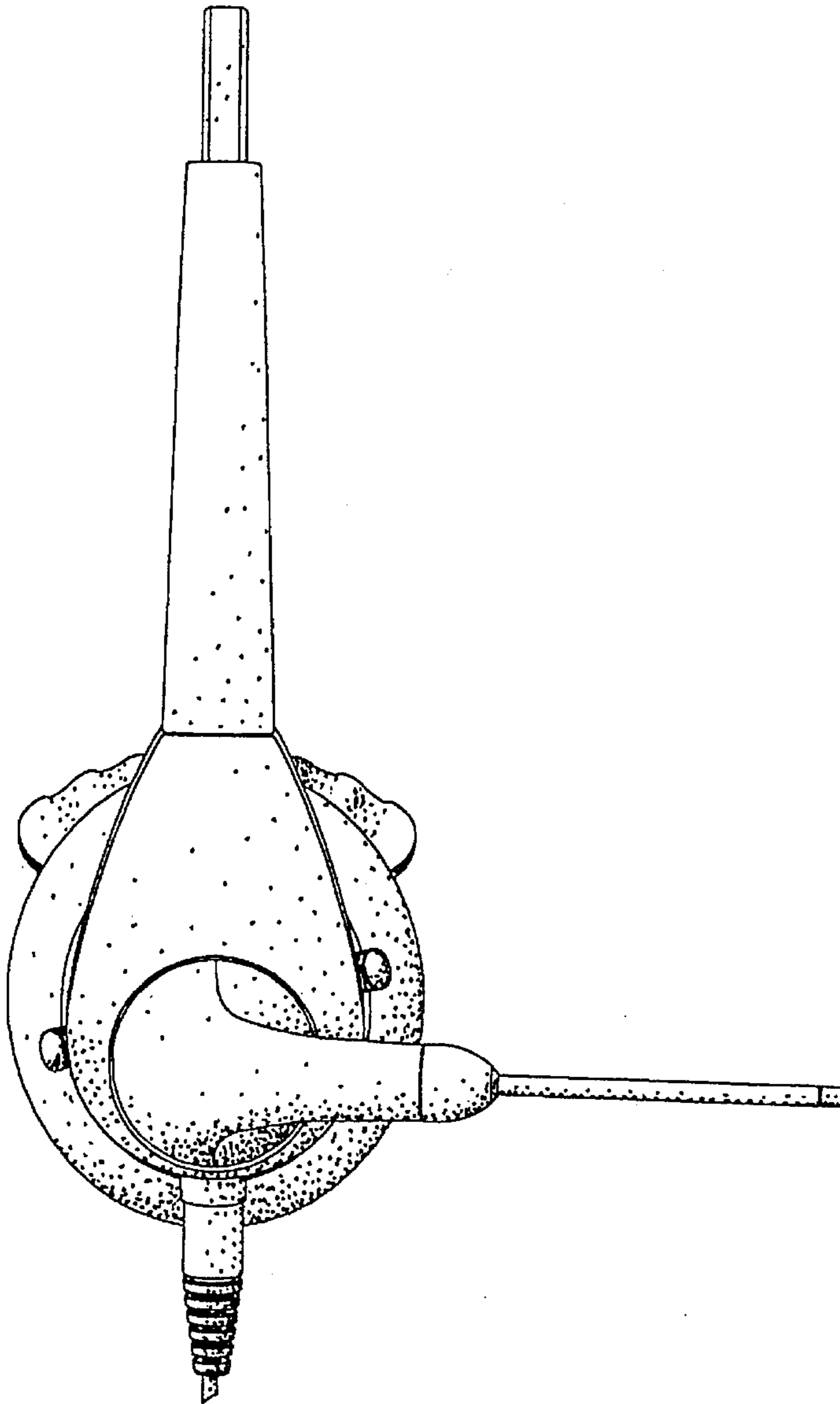
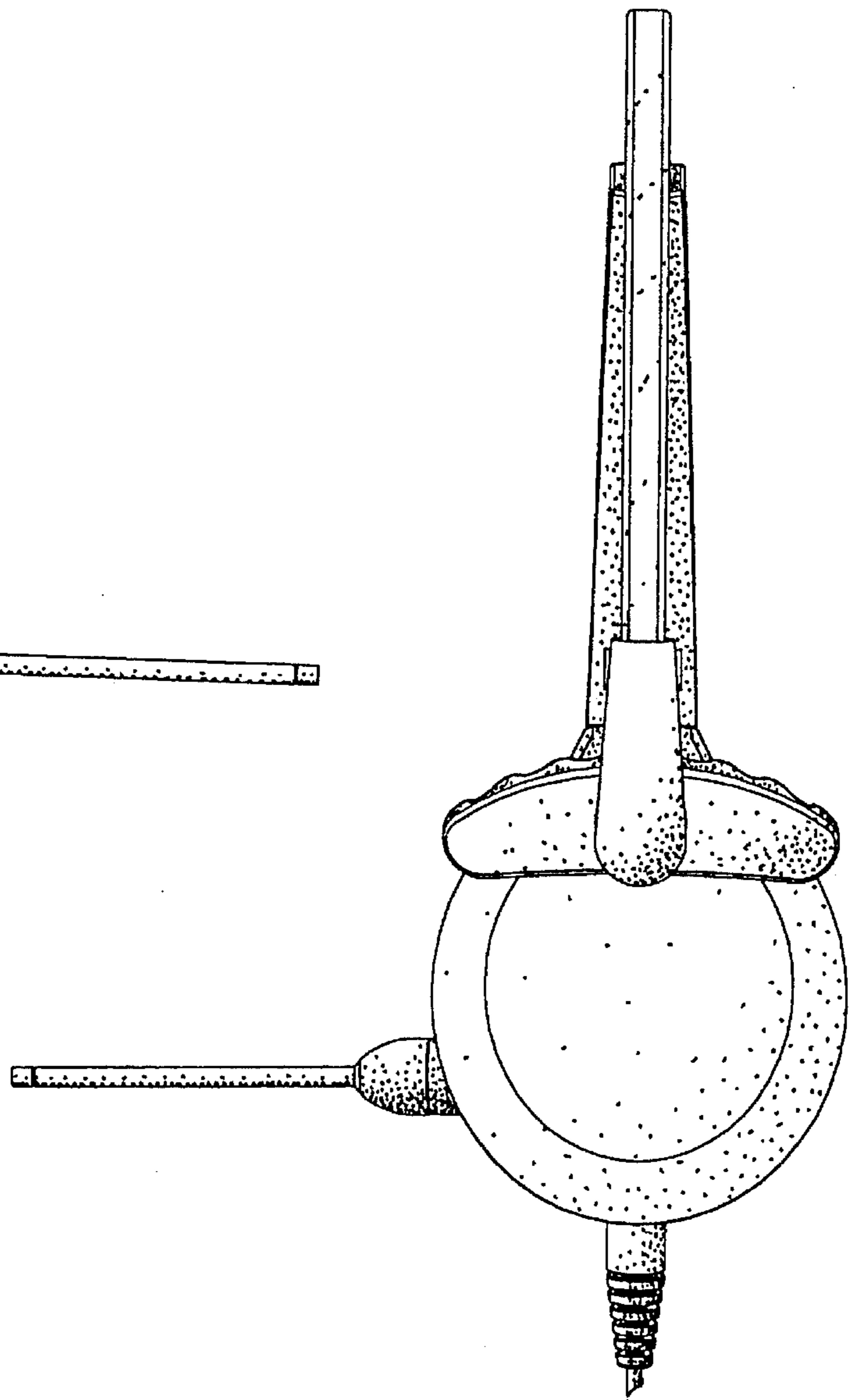

FIG. 4

FIG. 5



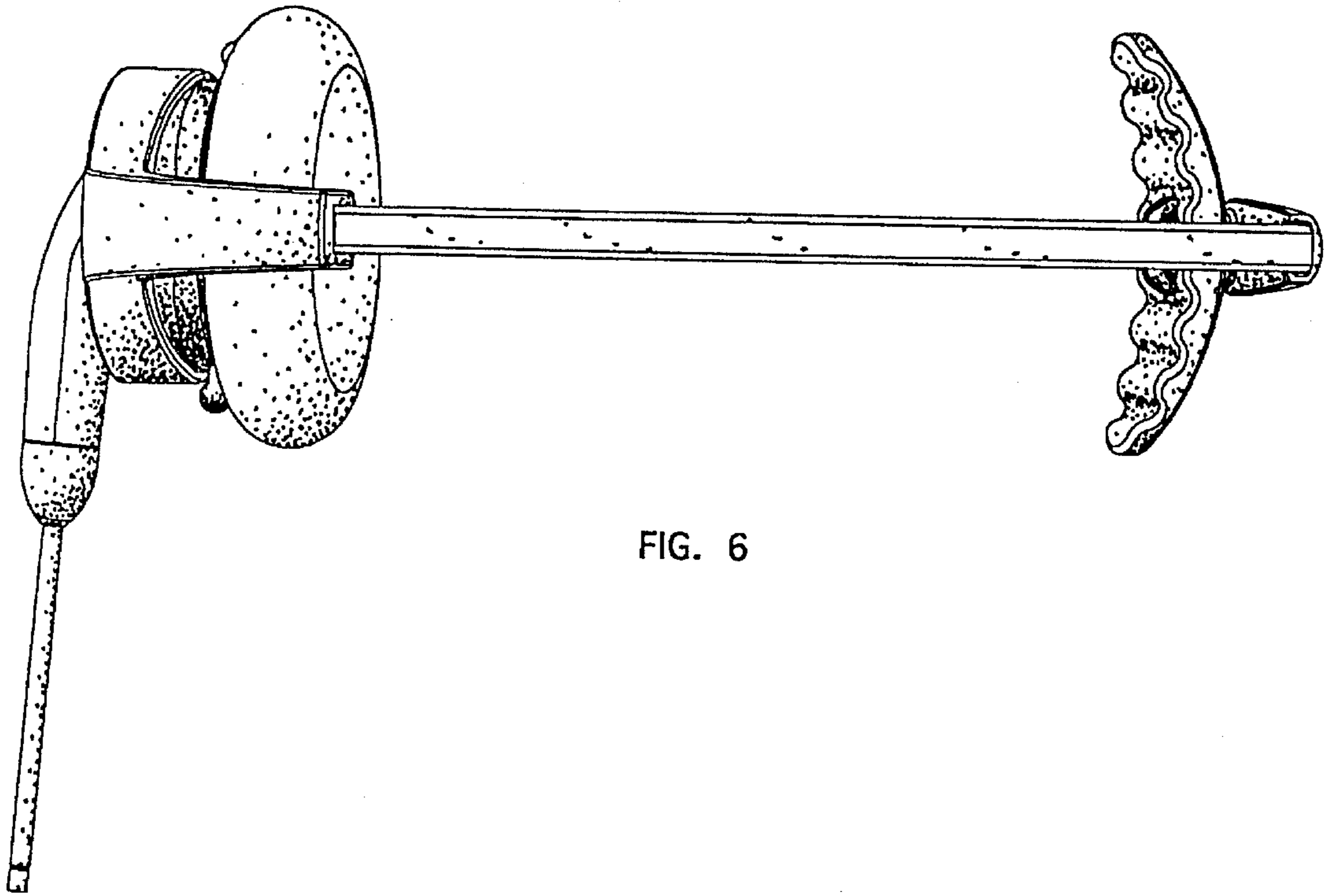

FIG. 6

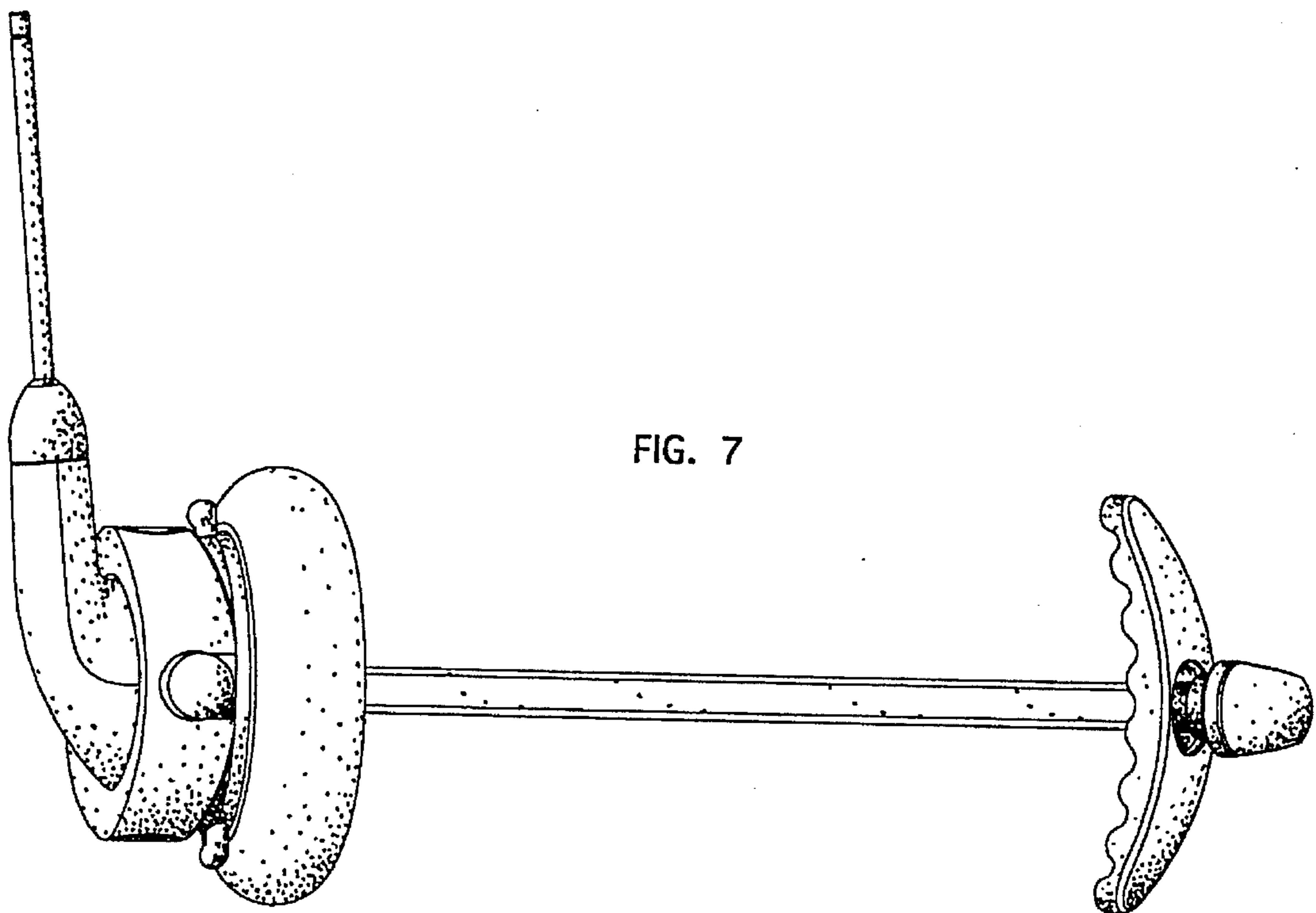

FIG. 7